



Machine Automation Controller NJ-series

EtherCAT(R) Connection Guide

OMRON Corporation

Multi-function Compact Inverter
(3G3MX2 Series Type V1)

Network
Connection
Guide

About Intellectual Property Rights and Trademarks

Microsoft product screen shots reprinted with permission from Microsoft Corporation.

Windows is a registered trademark of Microsoft Corporation in the USA and other countries.

EtherCAT(R) is registered trademark and patented technology, licensed by Beckhoff Automation GmbH, Germany.

Sysmac is a trademark or registered trademark of OMRON Corporation in Japan and other countries for OMRON factory automation products.

Company names and product names in this document are the trademarks or registered trademarks of their respective companies.

Table of Contents

1. Related Manuals	1
2. Terms and Definitions	2
3. Precautions	3
4. Overview	4
5. Applicable Devices and Device Configuration	5
5.1. Applicable Devices	5
5.2. Device Configuration.....	6
6. EtherCAT Settings	7
6.1. Parameters.....	7
6.2. PDO Mappings	8
6.3. Device Variables.....	9
7. EtherCAT Connection Procedure	11
7.1. Work Flow	11
7.2. Setting up Inverter	12
7.3. Setting up Controller	18
7.4. Checking the EtherCAT Communications.....	28
8. Initialization Method	32
8.1. Initializing the Controller.....	32
8.2. Initializing Inverter	32
9. Revision History	33

1. Related Manuals

To ensure system safety, make sure to always read and heed the information provided in all Safety Precautions and Precautions for Safe Use of manuals for each device which is used in the system.

The table below lists the manuals related to this document.

Cat. No.	Model	Manual name
W500	NJ501-□□□□ NJ301-□□□□ NJ101-□□□□	NJ-series CPU Unit Hardware User's Manual
W501	NJ501-□□□□ NJ301-□□□□ NJ101-□□□□	NJ/NX-series CPU Unit Software User's Manual
W505	NJ501-□□□□ NJ301-□□□□ NJ101-□□□□	NJ/NX-series CPU Unit Built-in EtherCAT(R) Port User's Manual
W504	SYSMAC-SE2□□□□	Sysmac Studio Version 1 Operation Manual
I585	3G3MX2-A□□□□-V1	Inverter Multi-function Compact Inverter MX2 Series Type V1 User's Manual
I574	3G3AX-MX2-ECT	Inverter MX2/RX Series EtherCAT(R) Communication Unit User's Manual

2. Terms and Definitions

Term	Explanation and Definition
PDO communications (Communications using Process Data Objects)	<p>This method is used for cyclic data exchange between a master unit and slave units.</p> <p>PDO data (i.e., I/O data that is mapped to PDOs) that is allocated in advance is refreshed periodically each EtherCAT process data communications cycle (i.e., the period of primary periodic task).</p> <p>The NJ-series Machine Automation Controller uses the PDO communications for commands to refresh I/O data in a fixed control period, including I/O data for slaves, and the position control data for servomotors.</p> <p>It is accessed from NJ-series Machine Automation Controller in the following ways.</p> <ul style="list-style-type: none"> • With device variables for a slave I/O • With axis variables for a servo drive and an encoder input slave to which assigned as an axis
SDO Communications (Communications using Service Data Objects)	<p>This method is used to read and write the specified slave unit data from a master unit when required.</p> <p>The NJ-series Machine Automation Controller uses SDO communications for commands to read and write data, such as for parameter transfers, at specified times.</p> <p>The NJ-series Machine Automation Controller can read/write the specified slave data (parameters and error information, etc.) with the EC_CoESDORead (Read CoE SDO) instruction or the EC_CoESDOWrite (Write CoE SDO) instruction.</p>
Slave unit	<p>There are various types of slaves such as servo drives that handle position data and I/O terminals that handle bit signals.</p> <p>A slave unit receives output data sent from a master, and sends input data to a master.</p>
Node address	<p>A node address is an address to identify a unit connected to EtherCAT.</p>

3. Precautions

- (1) Understand the specifications of devices which are used in the system. Allow some margin for ratings and performance. Provide safety measures, such as installing safety circuit, in order to ensure safety and minimize risks of abnormal occurrence.
- (2) To ensure system safety, make sure to always read and heed the information provided in all Safety Precautions and Precautions for Safe Use of manuals for each device which is used in the system.
- (3) The user is encouraged to confirm the standards and regulations that the system must conform to.
- (4) It is prohibited to copy, to reproduce, and to distribute a part or the whole of this document without the permission of OMRON Corporation.
- (5) The information contained in this document is current as of September 2015. It is subject to change without notice for improvement.

The following notations are used in this document.



WARNING

Indicates a potentially hazardous situation which, if not avoided, will result in minor or moderate injury, or may result in serious injury or death. Additionally there may be significant property damage.



Caution

Indicates a potentially hazardous situation which, if not avoided, may result in minor or moderate injury or property damage.



Precautions for Correct Use

Precautions on what to do and what not to do to ensure proper operation and performance.



Additional Information

Additional information to read as required.

This information is provided to increase understanding or make operation easier.

Symbol



The filled circle symbol indicates operations that you must do. The specific operation is shown in the circle and explained in text. This example shows a general precaution for something that must do.

4. Overview

This document describes the procedures for connecting 3G3MX2 Series Type V1 Multi-function Compact Inverter (hereinafter referred to as Inverter) of OMRON Corporation (hereinafter referred to as OMRON) to NJ-series Machine Automation Controller (hereinafter referred to as Controller) via EtherCAT and the procedures for checking their connections. Refer to *Section 6. EtherCAT Settings* and *Section 7. EtherCAT Connection Procedure* to understand the setting method and key points to operate PDO Communications via EtherCAT. In this document, the operations for PDO communications via EtherCAT are checked by the output frequency setting and the status check of Inverter.

5. Applicable Devices and Device Configuration

5.1. Applicable Devices

The applicable devices are as follows:

Manufacturer	Name	Model
OMRON	NJ-series CPU Unit	NJ501-□□□□ NJ301-□□□□ NJ101-□□□□
OMRON	Inverter	3G3MX2-A□□□□-V1
OMRON	EtherCAT Communication Unit	3G3AX-MX2-ECT



Precautions for Correct Use

As applicable devices above, the devices with the models and versions listed in 5.2. *Device Configuration* are actually used in this document to describe the procedure for connecting devices and checking the connection.

You cannot use devices with versions lower than the versions listed in 5.2.

To use the above devices with models not listed in 5.2. or versions higher than those listed in 5.2., check the differences in the specifications by referring to the manuals before operating the devices.



Additional Information

This document describes the procedures to establish the network connections.

It does not provide information on operation, installation, wiring method, device functionality, or device operation which is not related to the connection procedures. Refer to the manuals or contact the device manufacturer.

5.2. Device Configuration

The hardware components to reproduce the connection procedures of this document are as follows:

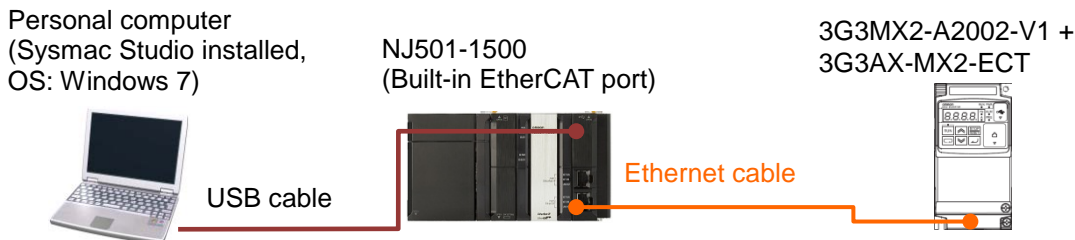

Manufacturer	Name	Model	Version
OMRON	CPU Unit (Built-in EtherCAT port)	NJ501-1500	Ver.1.10
OMRON	Power Supply Unit	NJ-PA3001	
OMRON	Sysmac Studio	SYSMAC-SE2[] [] [] []	Ver.1.13
-	Personal computer (OS: Windows 7)	-	
-	USB cable (USB 2.0 type B connector)	-	
OMRON	Ethernet cable (with industrial Ethernet connector)	XS5W-T421-[]M[]-K	
OMRON	Inverter	3G3MX2- A2002-V1	V2.0
OMRON	EtherCAT Communication Unit	3G3AX-MX2-ECT	Rev.1.1

Precautions for Correct Use

The connection line of EtherCAT communications cannot be shared with other Ethernet networks. Do not use devices for Ethernet such as a switching hub.

Use the Ethernet cable (double shielding with aluminum tape and braiding) of Category 5 or higher, and use the shielded connector of Category 5 or higher.

Connect the cable shield to the connector hood at both ends of the cable.

Precautions for Correct Use

Update Sysmac Studio to the version specified in this clause or higher version.

If you use a version higher than the one specified in this clause, the procedures and related screenshots described in *Section 7.* and subsequent sections may not be applicable.

In that case, use the equivalent procedures by referring to the *Sysmac Studio Version 1 Operation Manual* (Cat. No. W504).

Additional Information

For specifications of the Ethernet cables and network wirings, refer to *Section 4. EtherCAT Network Wiring* of the *NJ/NX-series CPU Unit Built-in EtherCAT(R) Port User's Manual* (Cat. No. W505).

Additional Information

The system configuration in this document uses USB for the connection to Controller.

For information on how to install a USB driver, refer to *A-1 Driver Installation for Direct USB Cable Connection* of the *Sysmac Studio Version 1 Operation Manual* (Cat. No. W504).

6. EtherCAT Settings

This section describes the specifications of parameters, PDO mappings, and device variables that are set in this document.

Hereinafter, Inverter is referred to as "Slave Unit" in some descriptions.

6.1. Parameters

The parameters required for connecting Controller and Inverter via EtherCAT are given below. Use the following settings when you perform 7.2.1. *Hardware Settings* and 7.2.2. *Parameter Settings*.

Name	Item	Set value	Description
Inverter	Node address	1	-
	A001 (1st Frequency Reference Selection)	04	Option (Using EtherCAT Communication Unit mounted on Inverter.)
	A002 (1st RUN Command Selection)	04	
	C102 (Reset Selection)	03	Trip reset only

6.2. PDO Mappings

The PDO entries (objects) of Inverter required to connect Controller and Inverter via EtherCAT are shown below for the connection checks described in this document.

Use the following settings when you perform 7.3.2. *PDO Map Settings*.

■ Output (Controller to Inverter)

Index	PDO entry name
0x5000:00	Command
0x5010:00	Frequency reference

The screenshot shows the 'PDO Map' configuration window. On the left, the 'Process Data Size' is set to Input 40 [bit] / 320 [bit] and Output 32 [bit] / 320 [bit]. The 'Selection' tab is active, showing 'Output' selected for the '258th receive PDO Mapping'. On the right, a table lists the PDO entries included in this mapping:

Index	Size	Data type	PDO entry name
0x5000:00	16 [bit]	WORD	Command
0x5010:00	16 [bit]	INT	Frequency reference

■ Input (Inverter to Controller)

Index	PDO entry name
0x5100:00	Status
0x5110:00	Output frequency monitor
0x2002:01	Sysmac Error Status

The screenshot shows the 'PDO Map' configuration window. On the left, the 'Process Data Size' is set to Input 40 [bit] / 320 [bit] and Output 32 [bit] / 320 [bit]. The 'Selection' tab is active, showing 'Input' selected for the '258th transmit PDO Mapping'. On the right, a table lists the PDO entries included in this mapping:

Index	Size	Data type	PDO entry name
0x5100:00	16 [bit]	WORD	Status
0x5110:00	16 [bit]	INT	Output frequency monitor

The screenshot shows the 'PDO Map' configuration window. On the left, the 'Process Data Size' is set to Input 40 [bit] / 320 [bit] and Output 32 [bit] / 320 [bit]. The 'Selection' tab is active, showing 'Input' selected for the '512th transmit PDO Mapping'. On the right, a table lists the PDO entries included in this mapping:

Index	Size	Data type	PDO entry name
0x2002:01	8 [bit]	BYTE	Sysmac Error Status



Additional Information

For details on PDO mappings of Inverter, refer to *Section 4. Inverter Control* of the *Inverter MX2/RX Series EtherCAT(R) Communication Unit User's Manual* (Cat. No. I574).

6.3. Device Variables

The PDO communications data for Inverter are allocated to the Controller's device variables.

The device variables and the data types are shown below.

The contents described in this clause are set in 7.3.3. *Setting the Device Variables*.

■ Output area (Controller to Inverter)

Device variable name	Data type	Index	Description
E001_Command	WORD	0x5000:00	Command: Operation command to Inverter
E001_Frequency_reference	INT	0x5010:00	Frequency reference: Gives an output frequency (Unit: 0.01 Hz)



Precautions for Correct Use

Do not give a negative value to E001_Frequency_reference (frequency reference).

*Details of bit data allocations for the command

Bit	Name	Meaning
0	Forward/stop	0: Stop 1: Forward command
1	Reverse/stop	0: Stop 1: Reverse command
7	Fault reset	↑: Resets an error or trip for EtherCAT Communication Unit or Inverter.
Other	(Reserved)	The reserved area. Set 0.

■ Input area (Inverter to Controller)

Device variable name	Data type	Index	Description
E001_Status	WORD	0x5100:00	Status: The present state of EtherCAT Communications Unit.
E001_Output_frequency_monitor	INT	0x5110:00	Output frequency monitor: Displays an output frequency (Unit: 0.01 Hz).
E001_Sysmac_Error_Status	BYTE	0x2002:01	Sysmac Error Status
E001_Observation	BOOL		Error description of observation
E001_Minor_Fault	BOOL		Error description of minor fault level

Details of bit data allocations for the status

Bit	Name	Meaning
0	Forward operation in progress	0: Stopped/during reverse operation 1: During forward operation
1	Reverse operation in progress	0: Stopped/during forward operation 1: During reverse operation
3	Fault	0: No error or trip occurred for EtherCAT Communication Unit or Inverter. 1: Error or trip occurred for EtherCAT Communication Unit or Inverter.
7	Warning	0: No warning occurred for EtherCAT Communication Unit or Inverter. 1: Warning occurred for EtherCAT Communication Unit or Inverter.
9	Remote	0: Local (Operations from EtherCAT are disabled) 1: Remote (Operations from EtherCAT are enabled)
12	Frequency matching	0: During acceleration/deceleration or stopped 1: Frequency matched
15	Connection error between the optional unit and Inverter	0: Normal 1: Error (Cannot update data for the inverter. To restore, turn the power OFF and then ON again.)
Other	(Reserved)	The reserved area. Set 0.



Additional Information

The device variables are named automatically from a combination of the device names and the port names.

The default device names are "E" followed by a serial number that starts from 001.



Additional Information

For details on the allocations of input and output areas, refer to *Section 4. Inverter Control of the Inverter MX2/RX Series EtherCAT(R) Communication Unit User's Manual (Cat. No. I574)*.

7. EtherCAT Connection Procedure

This section describes the procedures for connecting Controller to Inverter via EtherCAT. In this document, the explanations of procedures for setting up Controller and Inverter are based on the factory default settings.

For the initialization, refer to *Section 8. Initialization Method*.

7.1. Work Flow

Take the following steps to perform PDO Communications of EtherCAT.

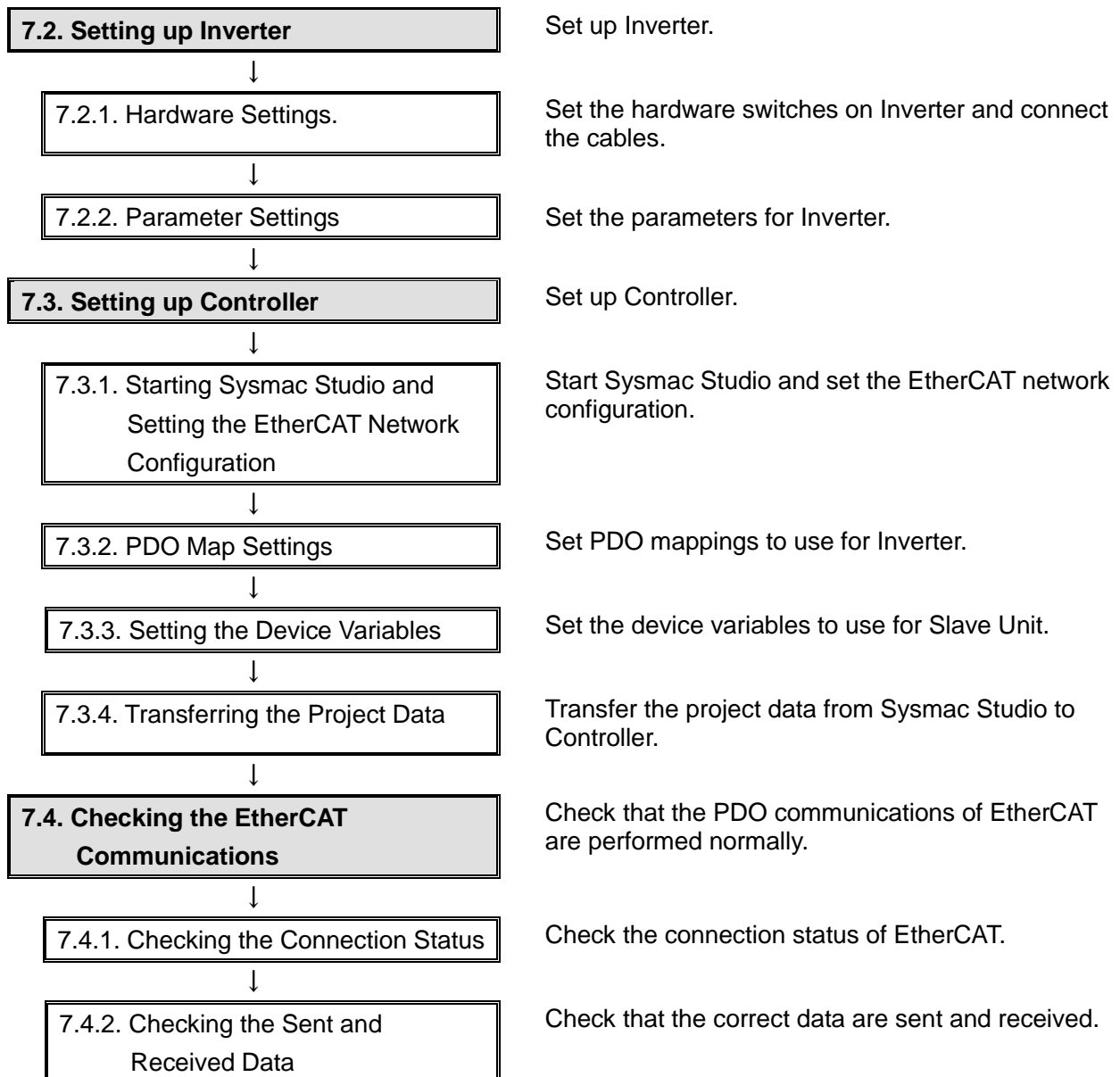

7.2. Setting up Inverter

Set up Inverter.

7.2.1. Hardware Settings

Set the hardware switches on Inverter and connect the cables.



Precautions for Correct Use

Make sure that the power supply is OFF when you perform the setting up.

- 1 Make sure that the power supply to Inverter is OFF.

*If the power supply is turned ON, settings may not be applicable as described in the following procedure.

- 2 Remove Option Unit Cover from the Inverter front panel as shown in the right figure.

1. Loosen the mounting screw (x 1) from Option Unit Cover of the Inverter front panel.
2. Remove Option Unit Cover.

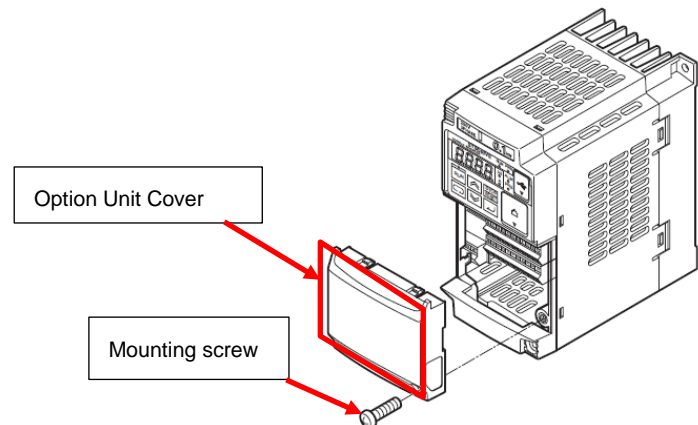

- 3 Connect 3-Phase 200 VAC power supply to Main power supply input terminal on Inverter.

*For details on wiring specifications of the power supply, refer to 2-3 *Wiring of the Inverter Multi-function Compact Inverter MX2 Series Type V1 User's Manual* (Cat. No. I585).

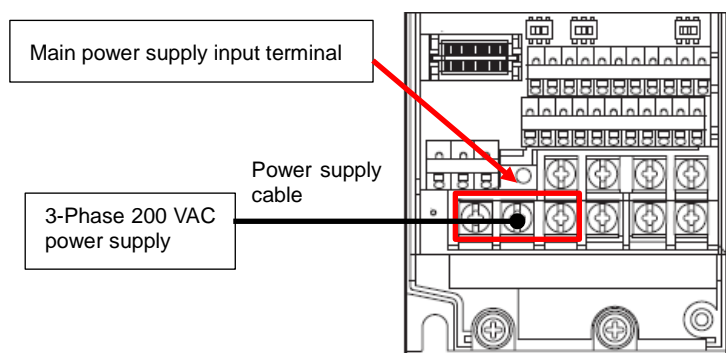

4 Mount EtherCAT Communication Unit onto Inverter as shown in the right figure.

*For mounting EtherCAT Communication Unit, refer to 2-5 *Mounting and Wiring for the EtherCAT Communication Unit of the Inverter MX2/RX Series EtherCAT(R) Communication Unit User's Manual* (Cat. No. I574).

*For details on the FG cable to ground, refer to 2-3 *Wiring of the Inverter Multi-function Compact Inverter MX2 Series Type V1 User's Manual* (Cat. No. I585).

1. Mount EtherCAT Communication Unit onto the location where Inverter Option Unit Cover that you removed was attached. Check that the connector is firmly connected.

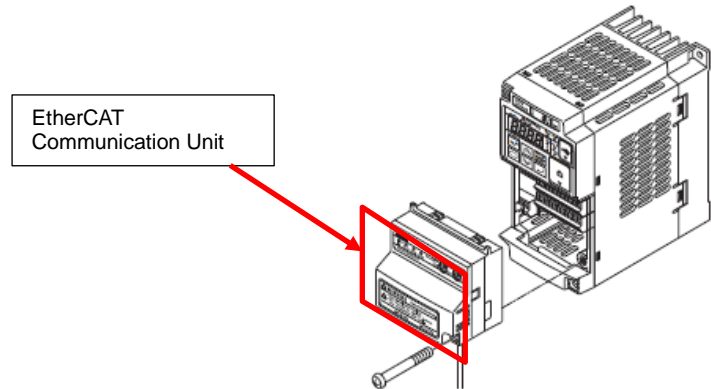

Note: When EtherCAT Communication Unit is mounted, the main circuit and control circuit terminals of Inverter are hidden. For this reason, be sure to wire the main circuit and control circuit terminals before mounting EtherCAT Communication Unit.

2. Tighten the bottom right screw of EtherCAT Communication Unit with the specified torque (46 N•cm, 4.7 kgf•cm).

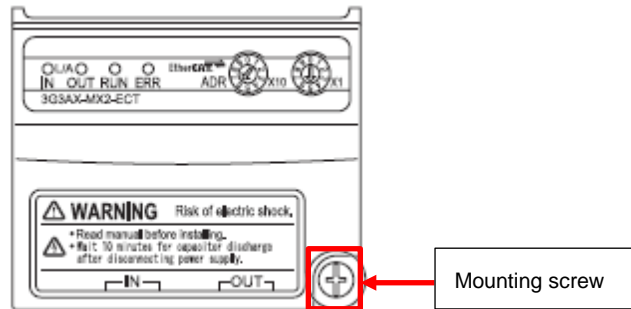

3. Ground the FG cable of EtherCAT Communication Unit. Cut the ground wire of the unit's FG cable to an appropriate length and ground it to the closest possible ground location.

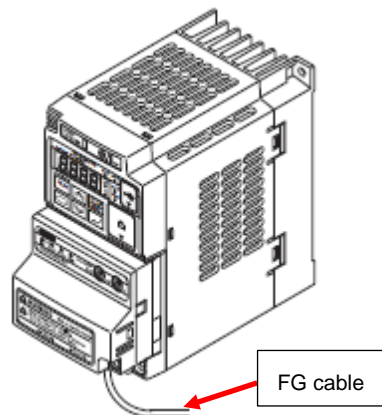

Note: Do not force the FG cable into EtherCAT Communication Unit during wiring.

5 Check the positions of the hardware switches and the connectors on EtherCAT Communication Unit by referring to the right figure.

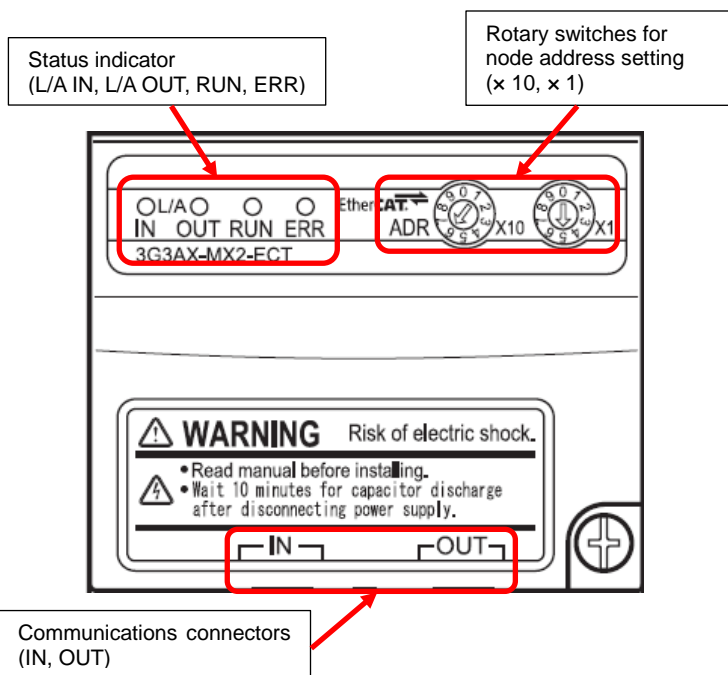

6 Set the rotary switches for node address setting as follows:

X10: 0
X1: 1

*Set the node address to 1.

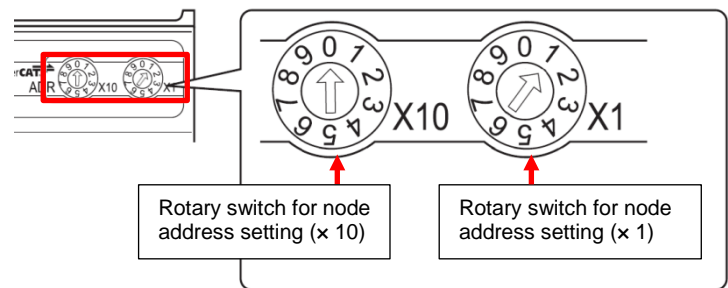

7 Connect an Ethernet cable to Communications connector (IN).

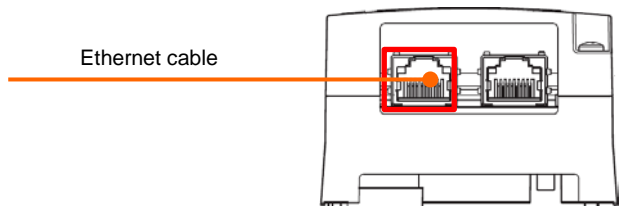

7.2.2. Parameter Settings

Set the parameters for Inverter.

In this document, the parameters are set by Digital Operator (display operation panel) on Inverter.



Additional Information

If you set the parameters for Inverter by Sysmac Studio, refer to 5-4 Setting EtherCAT Drives of the Sysmac Studio Version 1 Operation Manual (Cat. No. W504) and the Inverter MX2/RX Series EtherCAT(R) Communication Unit User's Manual (Cat. No. I574).

- 1 Check the positions of Data display and Operation keys on Digital Operator.

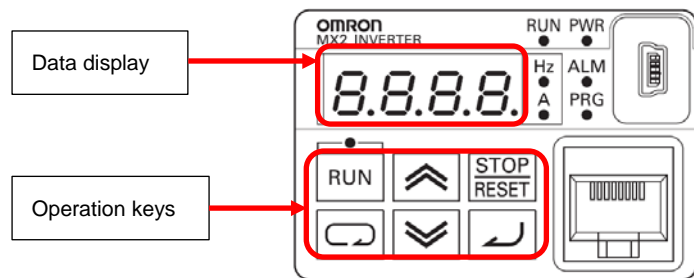

Digital Operator

Display	Name	Description
	POWER LED	Lights (green) when the inverter power is turned on.
	RUN LED	Lights (green) when the inverter is running. (Because this LED is designed to light based on the result of logical OR operation between the conditions "RUN command present" and "Inverter output in progress," it also lights when the RUN command is input with the frequency set to 0 Hz, or during deceleration after the RUN command turns OFF.)
	Monitor LED (Hz)	Lights (green) when a frequency value is displayed on the display.
	Monitor LED (A)	Lights (green) when a current value is displayed on the display.
	Data display	Displays (in red) various data such as a parameter value, frequency value, or set value.
	RUN key	Starts inverter operation. Note that this key is enabled when the RUN command is set to Digital Operator.
	STOP/RESET key	Stops the inverter (deceleration stop). (Although the STOP/RESET key is enabled even when the RUN command is set to other than Digital Operator, you can disable it by setting the parameter b087.) When the inverter is in a trip error state, pressing this key causes a reset (and the inverter recovers from the trip error state).
	Mode key	When parameter is displayed: Moves to the beginning of the next parameter group. When data is displayed: Cancels the setting and returns to the parameter display. In individual input mode: Moves the blinking position one digit to the left, if not located at the leftmost digit. At the leftmost digit, moves the blinking position to the rightmost digit. Regardless of the display, if you press the Mode key for 3 seconds or more, the data of Output Frequency Monitor (d001) is displayed.
	Enter key	In parameter display mode: Switches to the data display. In data display mode: Enters and stores the set value (into the EEPROM) and returns to the parameter display. In individual input mode: Enters the value in the blinking position.
	Increment key	Increases the parameter number or the set data value. Press and hold the key to quickly increase the number or value. Press the increment key and the decrement key simultaneously to enter the individual input mode, where you can edit the value in each digit independently.
	Decrement Key	Decreases the parameter number or the set data value. Press and hold the key to quickly decrease the number or value. Press the increment key and the decrement key simultaneously to enter the individual input mode, where you can edit the value in each digit independently.

- 2 Turn ON the power supply to Inverter.

3 Use the procedure on the right to set the parameters as follows:

A001 (1st Frequency
Reference Selection): 04
(Option)
A002 (1st RUN Command
Selection) : 04 (Option)

0.00

The output frequency is displayed in Data display.



Press the  **Mode** Key 3 times.

A001

A001 parameter is displayed.



Press the  **Enter** Key.

02

The initial data is displayed.



Press the  **Increment** Key twice.

04

The data changes to "04".



Press the  **Enter** Key.

A001

A001 parameter is displayed again.



Press the  **Increment** Key twice.

A002

A002 parameter is displayed.



Press the  **Enter** Key.

02

The initial data is displayed.



Press the  **Increment** Key twice.

04

The data changes to "04".



Press the  **Enter** Key.

A002

A002 parameter is displayed again.

4 Use the procedure on the right to set the parameter as follows:

C102 (Reset Selection):
03 (Trip reset only)

A002



C001



C102



02



03



C102

Check that A002 parameter is displayed.

Press the  **Mode** Key twice

C001 parameter is displayed.

Press the  **Increment** Key to display C102 parameter.

C102 parameter is displayed.

Press the  **Enter** Key.

The initial data is displayed.

Press the  **Increment** Key once.

The data changes to "03".

Press the  **Enter** Key.

C102 parameter is displayed again.

5 Press and hold the  **Mode** Key for more than 3 seconds.

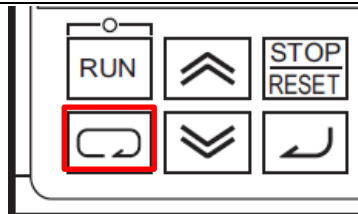

6 Check that the output frequency monitor is displayed.

The following items are displayed.

Data display: 0.00 Hz
(output frequency)

Monitor LED (Hz): Green lit

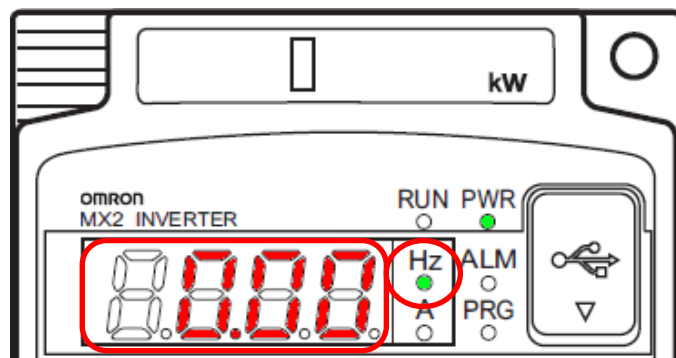



7.3. Setting up Controller

Set up Controller.

7.3.1. Starting Sysmac Studio and Setting the EtherCAT Network Configuration

Start Sysmac Studio and set the EtherCAT network configuration.

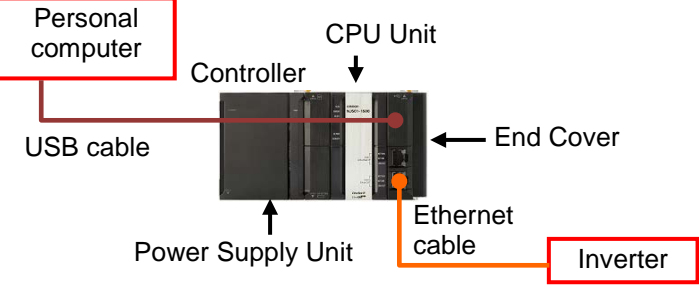
Install Sysmac Studio and a USB driver on Personal computer beforehand.

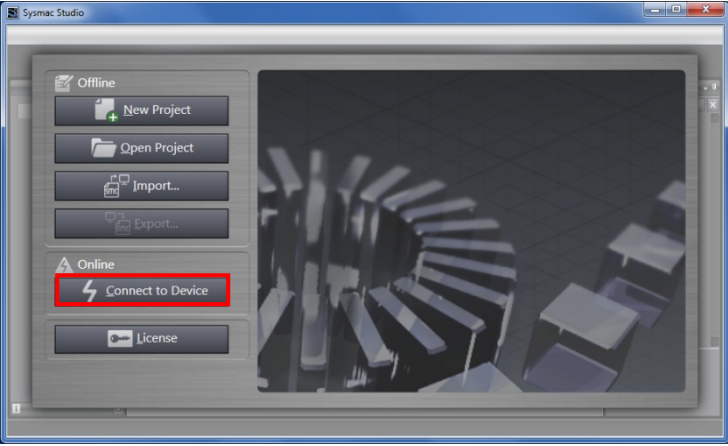
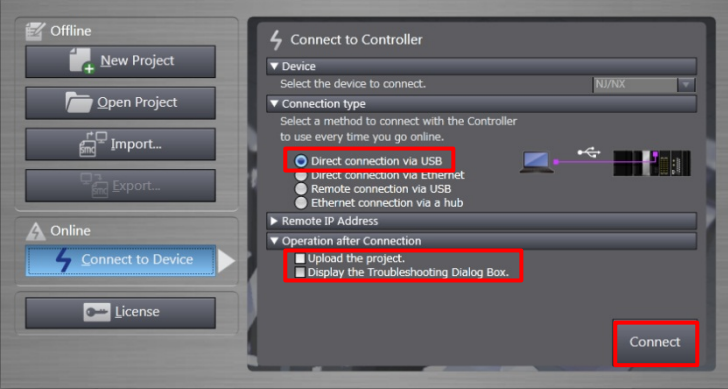
<p>1 Connect an Ethernet cable to Built-in EtherCAT port (PORT2) on Controller, and connect a USB cable to the peripheral (USB) port. As shown in 5.2. <i>Device Configuration</i>, connect Personal computer and Inverter to Controller.</p>	 <p>The diagram illustrates the hardware setup. A Personal computer is connected to the Controller via a USB cable. The Controller is connected to the CPU Unit. A Power Supply Unit is connected to the Controller. An End Cover is attached to the Controller. An Ethernet cable connects the Controller to an Inverter.</p>
<p>2 Turn ON the power supply to Controller.</p>	
<p>3 Start Sysmac Studio. *If a confirmation dialog for an access right is displayed at start, execute a selection to start.</p>	
<p>4 Sysmac Studio starts. Click Connect to Device.</p>	 <p>The screenshot shows the Sysmac Studio main window. The 'Connect to Device' button is highlighted with a red box.</p>
<p>5 The Connect to Controller Dialog Box is displayed. Select <i>Direct connection via USB</i> for Connection type. Uncheck <i>Upload the project</i> and <i>Display the Troubleshooting Dialog Box</i> for Operation after Connection. Click Connect.</p>	 <p>The screenshot shows the 'Connect to Controller' dialog box. The 'Direct connection via USB' option is selected under 'Connection type'. The 'Upload the project' and 'Display the Troubleshooting Dialog Box' options are unchecked under 'Operation after Connection'. The 'Connect' button is highlighted with a red box.</p>

6 A confirmation dialog box is displayed. Check the contents and click **Yes**.

*The displayed dialog depends on the status of Controller. Check the contents and click **OK** or **Yes** to proceed with the processing.

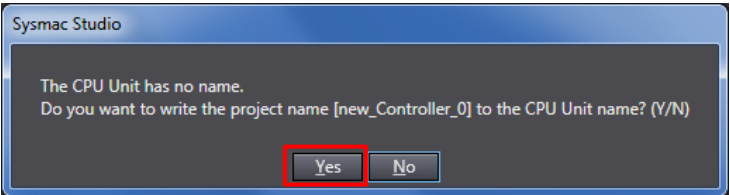

7 A dialog box on the right is displayed. Check the contents and click **OK**.

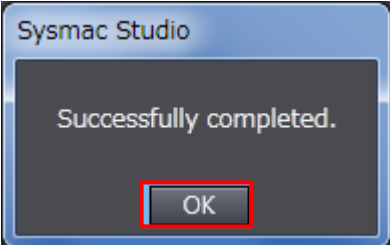

8 The Auto Connect Project Dialog Box is displayed online. When an online connection is established, a yellow bar is displayed under the toolbar.

The following panes are displayed in this window.

- Left: Multiview Explorer
- Top right: Toolbox
- Bottom right: Controller Status Pane
- Middle top: Edit Pane

The following tab pages are displayed at the middle bottom of the window.

- Output Tab Page
- Build Tab Page

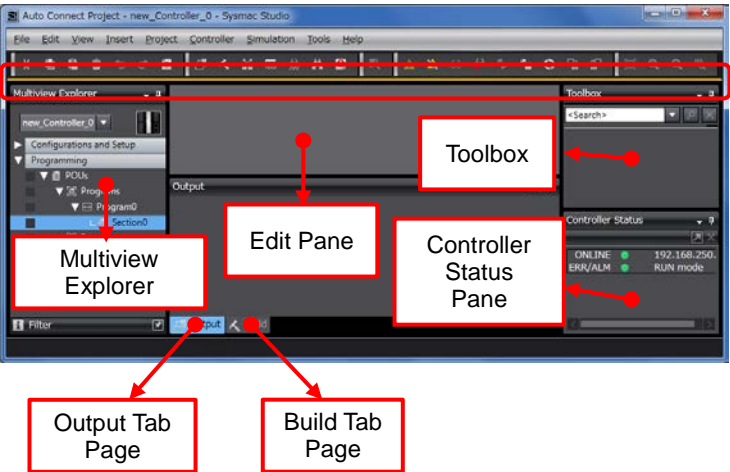



Additional Information

For details on online connections to Controller, refer to *Section 6. Online Connections to a Controller* of the *Sysmac Studio Version 1 Operation Manual* (Cat. No. W504).

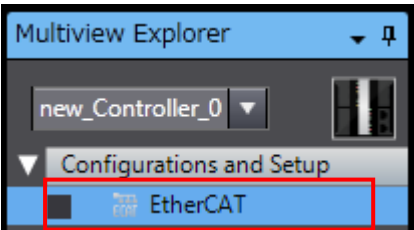
9 Double-click **EtherCAT** under **Configurations and Setup** in the Multiview Explorer.

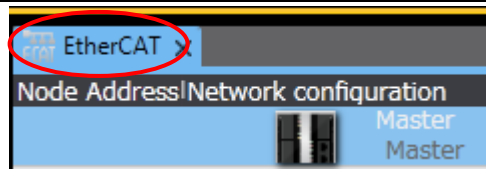

10 The EtherCAT Tab Page is displayed in the Edit Pane.



11 Right-click **Master** on the EtherCAT Tab Page and select **Compare and Merge with Actual Network Configuration**.

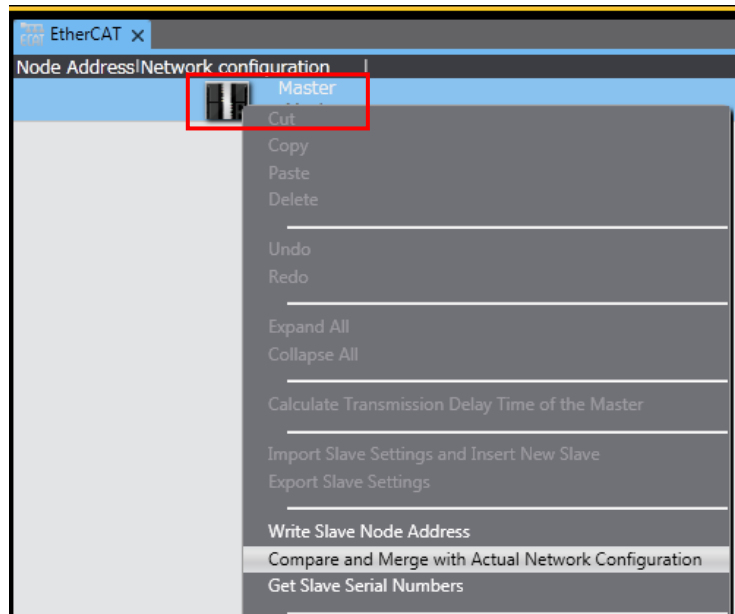

A screen is displayed stating "Get information is being executed".

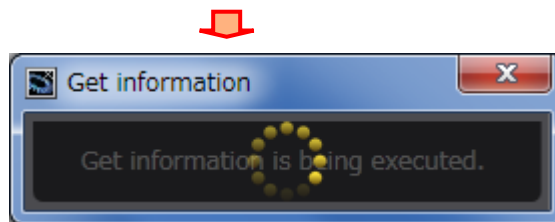

12 The Compare and Merge with Actual Network Configuration Dialog Box is displayed. Node address 1 and 3G3AX-MX2-ECT Rev:1.1 are added to the Actual network configuration after the comparison.

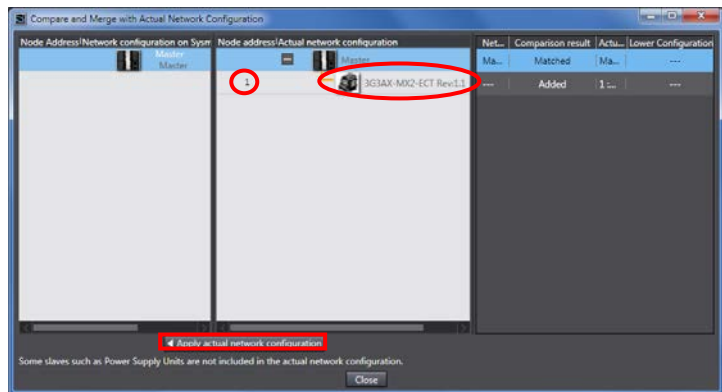

Click **Apply actual network configuration**.

13 A confirmation dialog box is displayed. Check the contents and click **Apply**.

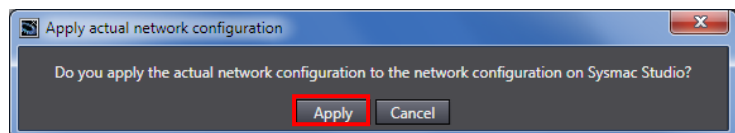

The dialog box on the right is displayed. Click **Close**.

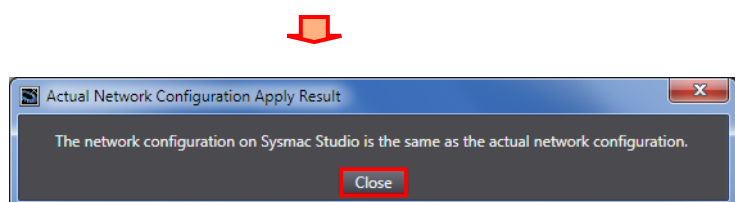

14 E001 3G3AX-MX2-ECT Rev:1.1 is added as a node address 1 to the Network configuration on Sysmac Studio.

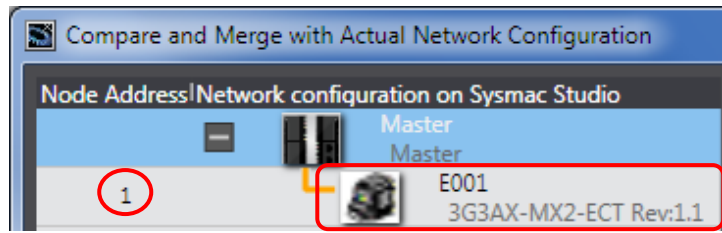

Check that the data above is added. Click **Close**.

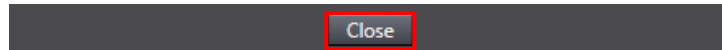

15 Node address 1 and the E001 3G3AX-MX2-ECT Rev:1.1 slave are added to the EtherCAT Tab Page in the Edit Pane.

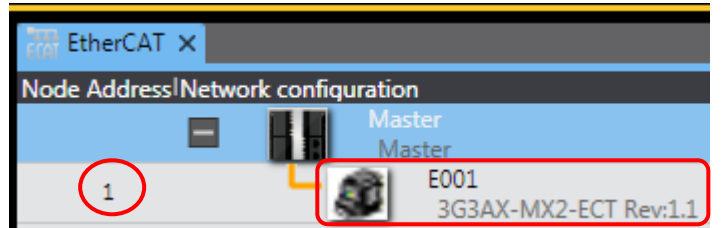

7.3.2. PDO Map Settings

Set PDO mappings to use for Inverter.

- 1 Select **Offline** from the Controller Menu.

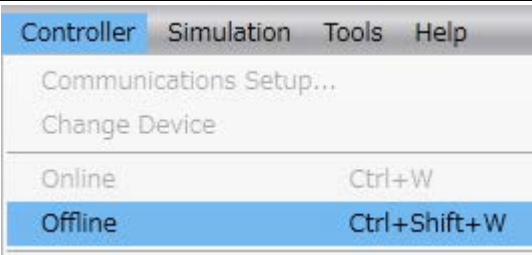

The yellow bar under the toolbar disappears.

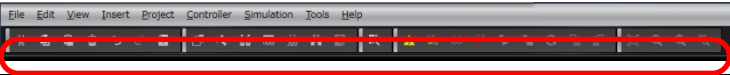

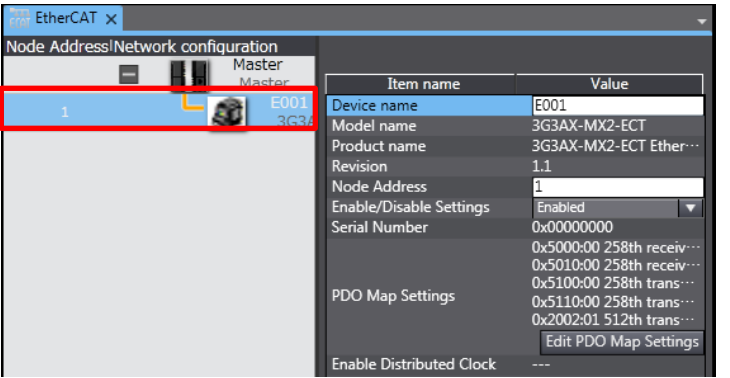
- 2 Select the slave unit for the node address 1 added in the previous sub-clause on the EtherCAT Tab Page.

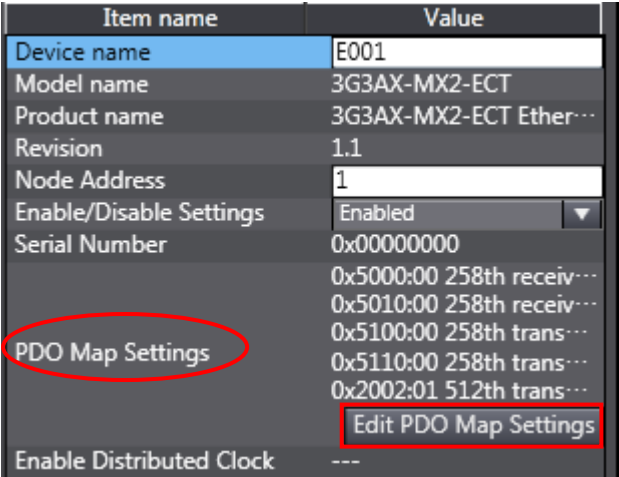
- 3 Click **Edit PDO Map Settings** in the *PDO Map Settings* Field.

- 4 The Edit PDO Map Settings Dialog Box is displayed.

Select *Output 258th receive PDO Mapping*.

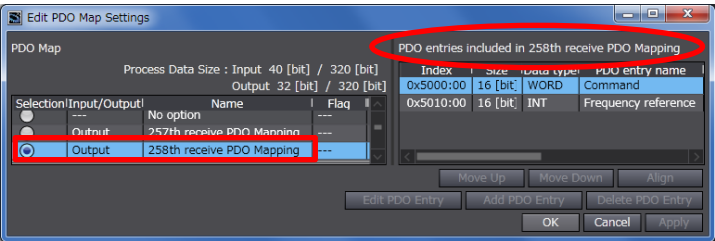
"PDO entries included in 258th receive PDO Mapping" is displayed on the right side of the dialog box.



Index	Size	Word Type	PDO entry name
0x5000:00	16 [bit]	WORD	Command
0x5010:00	16 [bit]	INT	Frequency reference

- 5 Check that the following objects are set.

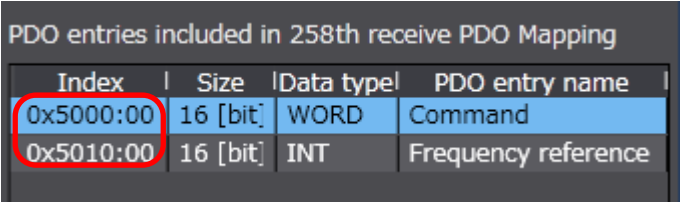
 - 0x5000:00
 - 0x5010:00

Index	Size	Data type	PDO entry name
0x5000:00	16 [bit]	WORD	Command
0x5010:00	16 [bit]	INT	Frequency reference
- 6 Select *Input 258th transmit PDO Mapping*.
 "PDO entries included in 258th transmit PDO Mapping" is displayed on the right side of the dialog box.

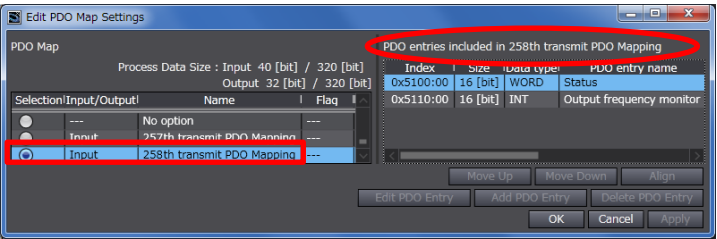
- 7 Check that the following objects are set.

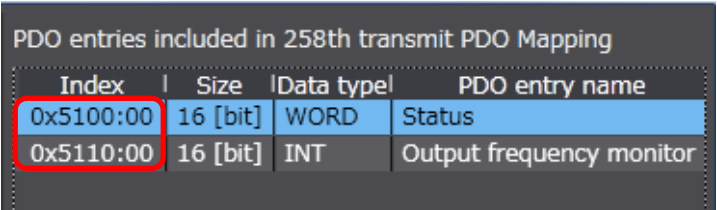
 - 0x5100:00
 - 0x5110:00

Index	Size	Data type	PDO entry name
0x5100:00	16 [bit]	WORD	Status
0x5110:00	16 [bit]	INT	Output frequency monitor
- 8 Select *Input 512th transmit PDO Mapping*.
 "PDO entries included in 512th transmit PDO Mapping" is displayed on the right side of the dialog box.

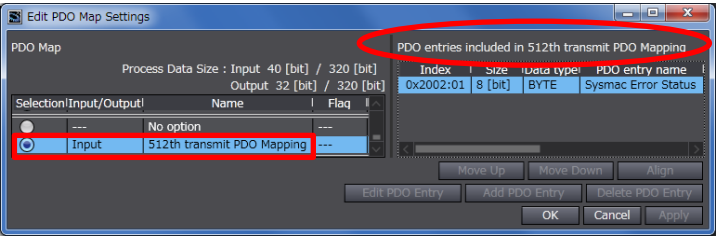
- 9 Check that the following objects are set.

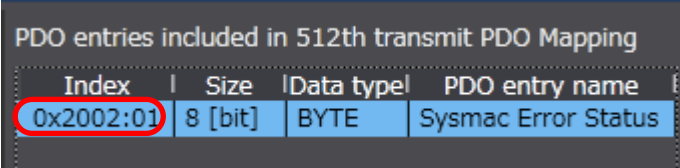
 - 0x2002:01

Index	Size	Data type	PDO entry name
0x2002:01	8 [bit]	BYTE	Sysmac Error Status
- 10 Click **OK**.

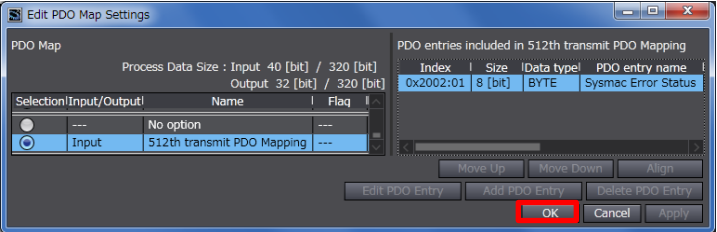

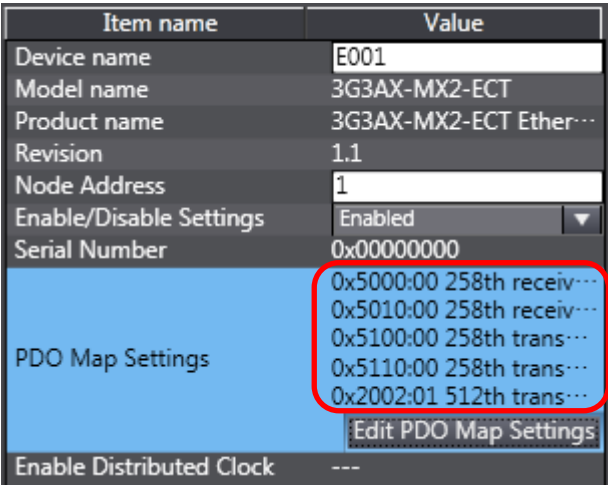
- 11 Check that the same PDO entries as those listed in 6.2. *PDO Mappings* are displayed in the *PDO Map Settings* Field.



Item name	Value
Device name	E001
Model name	3G3AX-MX2-ECT
Product name	3G3AX-MX2-ECT Ether...
Revision	1.1
Node Address	1
Enable/Disable Settings	Enabled
Serial Number	0x00000000
PDO Map Settings	
	0x5000:00 258th receiv...
	0x5010:00 258th receiv...
	0x5100:00 258th trans...
	0x5110:00 258th trans...
	0x2002:01 512th trans...
	Edit PDO Map Settings
Enable Distributed Clock	---

7.3.3. Setting the Device Variables

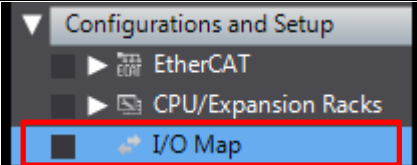
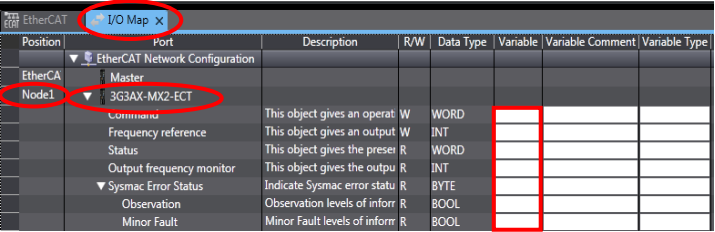
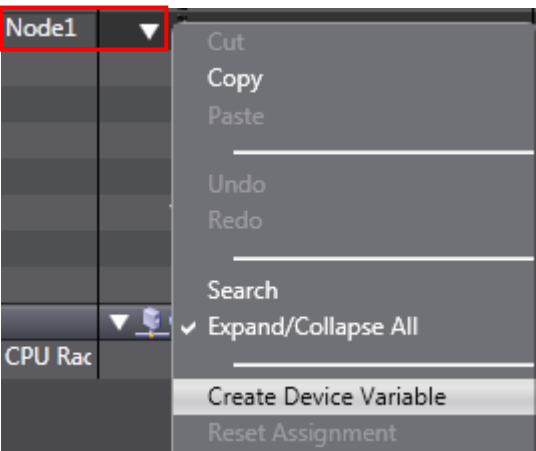
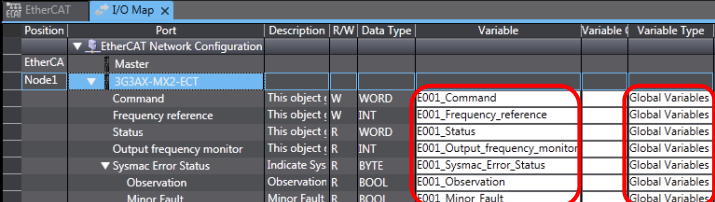
Set the device variables to use for Slave Unit.

<p>1 Double-click I/O Map under Configurations and Setup in the Multiview Explorer.</p>	
<p>2 The I/O Map Tab Page is displayed in the Edit Pane. Check that Node1 is displayed in the <i>Position</i> Column and the added Slave Unit is displayed in the <i>Port</i> Column.</p> <p>*To manually set a variable name for Slave Unit, click a column under the <i>Variable</i> Column and enter a name.</p>	
<p>3 Right-click Node1 and select Create Device Variable.</p>	
<p>4 The variable names and variable types are set.</p>	



Additional Information

The device variables are named automatically from a combination of the device names and the port names. The default device names are “E” followed by a serial number that starts from 001.



Additional Information

In this document, device variables are automatically named for a unit (a slave). Device variables can also be manually named for ports.

7.3.4. Transferring the Project Data

Transfer the project data from Sysmac Studio to Controller.

WARNING

When you transfer a user program, configuration data, setup data, device variables, or values in memory used for CJ-series Units from Sysmac Studio, the devices or machines may perform unexpected operation regardless of the operating mode of CPU Unit.

Always confirm safety at the destination node before you transfer the project data.



Caution

After transferring the project data, CPU Unit restarts and communications with slaves are cut off. During the period, the outputs of slaves behave according to the slave settings. The time that communications are cut off depends on the EtherCAT network configuration.

Before you transfer the project data, confirm that the slave settings will not adversely affect the device.



Caution

A slave will be reset after performing the synchronization in step 7 and subsequent steps, and the device may perform unexpected operations. Always confirm safety before performing the synchronization.

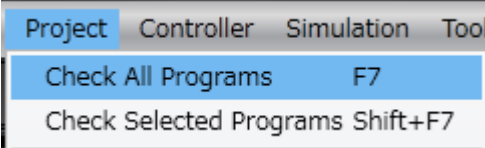
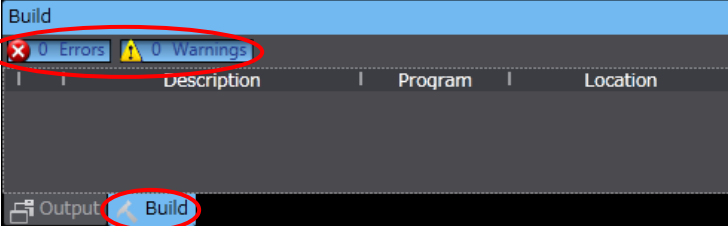
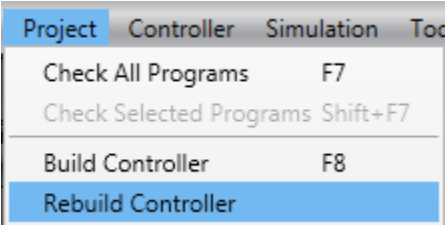

1	Select Check All Programs from the Project Menu.	
2	The Build Tab Page is displayed. Check that "0 Errors" and "0 Warnings" are displayed.	
3	Select Rebuild Controller from the Project Menu.	

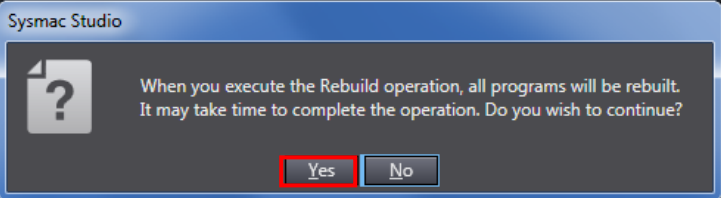
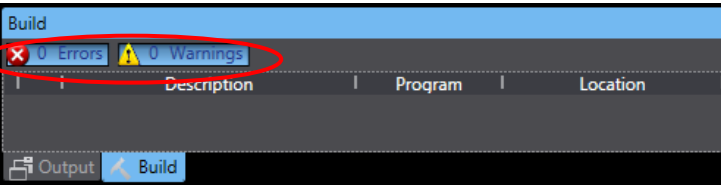
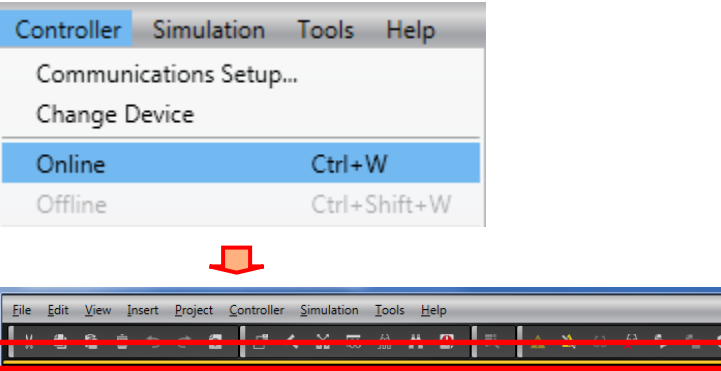
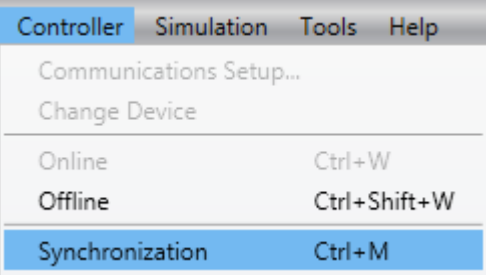
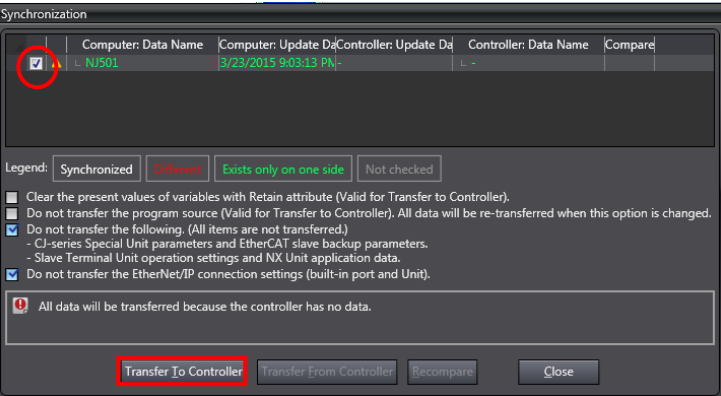
<p>4</p>	<p>A confirmation dialog box is displayed. Check that there is no problem and click Yes.</p>	
<p>5</p>	<p>Check that "0 Errors" and "0 Warnings" are displayed on the Build Tab Page.</p>	
<p>6</p>	<p>Select Online from the Controller Menu.</p> <p>When an online connection is established, a yellow bar is displayed under the toolbar.</p>	
<p>7</p>	<p>Select Synchronization from the Controller Menu.</p>	
<p>8</p>	<p>The Synchronization Dialog Box is displayed. Check that the data to transfer (NJ501 in the right dialog box) is selected. Then, click Transfer To Controller.</p> <p>*After executing Transfer To Controller, the Sysmac Studio data is transferred to Controller, and the data is compared.</p>	

9 A confirmation dialog box is displayed. Check that there is no problem and click **Yes**.

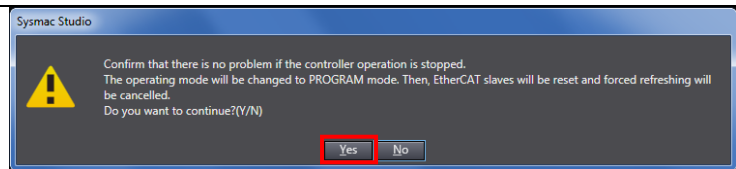

A screen stating "Synchronizing" is displayed.

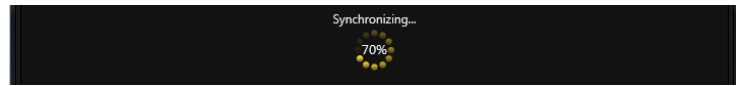

A confirmation dialog box is displayed. Check that there is no problem and click **No**.

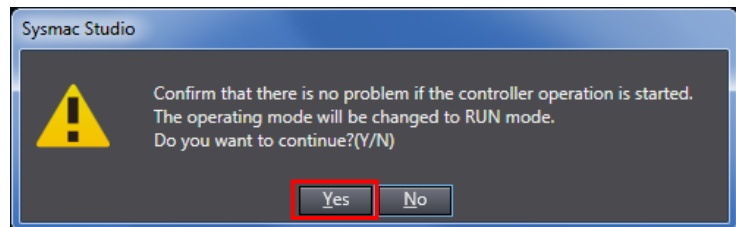

*Do not return to RUN mode.

10 Check that the synchronized data is displayed with the color specified by "Synchronized" and that a message is displayed stating "The synchronization process successfully finished". If there is no problem, click **Close**.

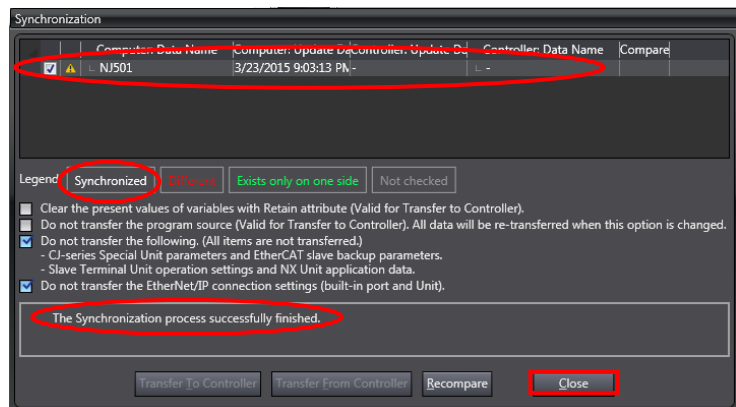

*A message stating "The synchronization process successfully finished" is displayed if the Sysmac Studio project data coincides with the Controller data.

*If the synchronization fails, check the wiring and repeat from step 1.

7.4. Checking the EtherCAT Communications

Check that the PDO communications of EtherCAT are performed normally.

7.4.1. Checking the Connection Status

Check the connection status of EtherCAT.

- 1 Check with LED indicators on Controller that PDO communications via EtherCAT are performed normally.

The LED indicators in normal status are as follows:
 NET RUN: Green lit
 NET ERR: Not lit
 LINK/ACT: Yellow flashing

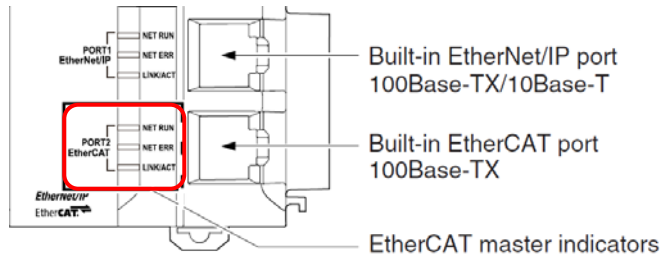

- 2 Check the LED indicators on EtherCAT Communication Unit.

The LED indicators in normal status are as follows:
 L/A IN: Green flickering
 RUN: Green lit
 ERR: Not lit



7.4.2. Checking the Sent and Received Data

Check that the correct data are sent and received.

The following procedure describes the steps required for checking that the correct data are sent or received by setting the output frequency of Inverter in the device variables for output area of Controller and by checking the output frequency monitor stored in the device variables for input area of Controller and the status of Inverter.

⚠ Caution

In this procedure, Inverter is output, which may perform unexpected operations. Take sufficient safety precautions and proceed to this operation check. If you cannot confirm safety, do not proceed to this section after completing until 7.4.1. *Checking the Connection Status*. If you proceed to this operation check, make sure to complete all the steps and place Inverter in the safe state.



⚠ Caution

If you wire the I/O in the state where the power supplies to the devices are turned ON, doing so may cause damage to the devices. Always read and heed the information provided in all safety precautions of manuals for each device to be wired.





⚠ Caution

If you change the values of variables on a Watch Tab Page in the online state, the devices connected to the output unit may operate regardless of the operating mode of CPU Unit. Sufficiently confirm safety before you change the values of variables on a Watch Tab Page when Sysmac Studio is online with CPU Unit.

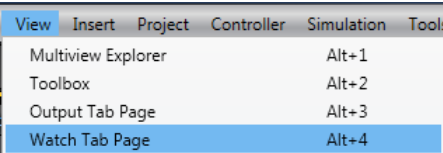

- 1 Select **Watch Tab Page** from the View Menu.

- 2 Select the **Watch1** Tab.

- 3 As shown below, enter the following name of the variables for monitoring. Click *Input Name* in the *Name* Column to enter a new name.

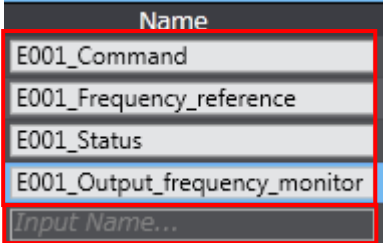
 - E001_Command*
 - E001_Frequency_reference*
 - E001_Status*
 - E001_Output_frequency_monitor*

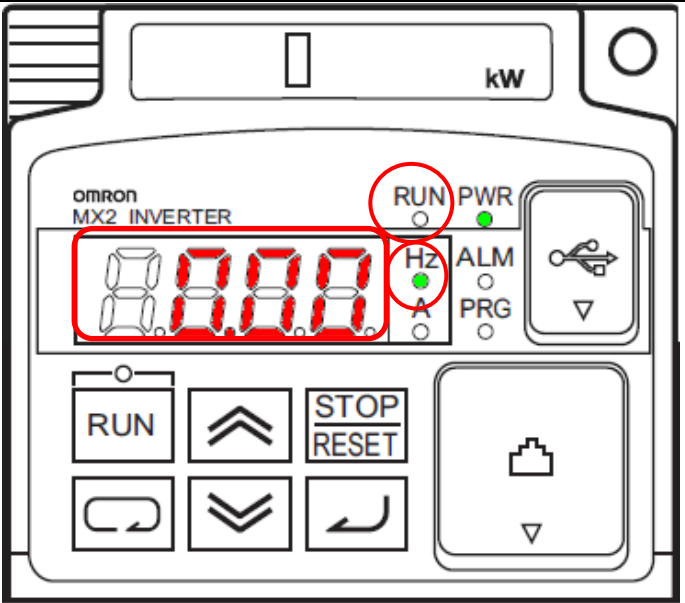
- 4 Check that the display formats are as follows:
E001_Command: Hexadecimal
E001_Frequency_reference: Decimal
E001_Status: Hexadecimal
E001_Output_frequency_monitor: Decimal
- | Name | Online value | Modify | Data type | Display format |
|-------------------------------|--------------|--------|-----------|----------------|
| E001_Command | 0000 | | WORD | Hexadecimal |
| E001_Frequency_reference | 0 | | INT | Decimal |
| E001_Status | 0200 | | WORD | Hexadecimal |
| E001_Output_frequency_monitor | 0 | | INT | Decimal |
- 5 Check that the online value for the *E001_Status* variable is 0200.
 *This means that the status bit 9 is "1" (Remote: Operations from EtherCAT are enabled).
- | Name | Online value | Modify |
|-------------------------------|--------------|--------|
| E001_Command | 0000 | |
| E001_Frequency_reference | 0 | |
| E001_Status | 0200 | |
| E001_Output_frequency_monitor | 0 | |
- 6 Check that the display on Inverter shows as follows:
 RUN LED: Not lit
 Data display: 0.00
 (Output frequency: 0.00 Hz)
 Monitor LED (Hz): Green lit
 *If the output frequency monitor is not displayed, take step 5 in 7.2.2. *Parameter Settings* to display.
- 
- 7 Enter 200 (2.00 Hz) in the *Modify* Column of the *E001_Frequency_reference* variable on the Watch1 Tab Page of Sysmac Studio.
 "200" is displayed in the *Online value* Column of the *E001_Frequency_reference* variable.
- | Name | Online value | Modify |
|-------------------------------|--------------|--------|
| E001_Command | 0000 | |
| E001_Frequency_reference | 0 | 200 |
| E001_Status | 0200 | |
| E001_Output_frequency_monitor | 0 | |
- | Name | Online value | Modify |
|-------------------------------|--------------|--------|
| E001_Command | 0000 | |
| E001_Frequency_reference | 200 | 200 |
| E001_Status | 0200 | |
| E001_Output_frequency_monitor | 0 | |
- 8 Enter 1 in the *Modify* Column of the *E001_Command* variable.
 *Set the command bit 0 to 1 (Forward command).
- | Name | Online value | Modify |
|-------------------------------|--------------|--------|
| E001_Command | 0000 | 1 |
| E001_Frequency_reference | 200 | 200 |
| E001_Status | 0200 | |
| E001_Output_frequency_monitor | 0 | |

- 9 Check that the online values of variables are as follows.
E001_Status: 1201
E001_Output_frequency_monitor: 200 (Output frequency: 2.00 Hz)
 *This means that the status bit 0 is "1" (During forward operation) and bit 12 is "1" (Frequency matched).
- | Name | Online value | Modify |
|-------------------------------|--------------|--------|
| E001_Command | 0001 | 1 |
| E001_Frequency_reference | 200 | 200 |
| E001_Status | 1201 | |
| E001_Output_frequency_monitor | 200 | |
- 10 Check that the display of Inverter shows as follows:
 RUN LED: Green lit
 Data display: 2.00
 (Output frequency: 2.00 Hz)
 Monitor LED (Hz): Green lit
-
- 11 Enter the following values in the *Modify Column* on the Watch1 Tab Page of Sysmac Studio..
E001_Command: 0
E001_Frequency_reference: 0 (0.00 Hz)
 *Set the command bit 0 to "0" (Stop).
- | Name | Online value | Modify |
|-------------------------------|--------------|--------|
| E001_Command | 0001 | 0 |
| E001_Frequency_reference | 200 | 0 |
| E001_Status | 1201 | |
| E001_Output_frequency_monitor | 200 | |
- 12 Check that the online values of variables are as follows:
E001_Status: 0200
E001_Output_frequency_monitor: 0 (Output frequency: 0.00 Hz)
 *This means that the status bit 0 is "0" (Stopped/during reverse operation) and bit 12 is "0" (During acceleration/deceleration or stopped).
- | Name | Online value | Modify |
|-------------------------------|--------------|--------|
| E001_Command | 0000 | 0 |
| E001_Frequency_reference | 0 | 0 |
| E001_Status | 0200 | |
| E001_Output_frequency_monitor | 0 | |
- 13 Check that the display of Inverter is as follows:
 RUN LED: Not lit
 Data display: 0.00
 (Output frequency: 0.00 Hz)
 Monitor LED (Hz): Green lit
-

8. Initialization Method

This document provides explanations of procedures based on the factory default settings. Some settings may not be applicable as described in this document unless you use the devices with the factory default settings.

8.1. Initializing the Controller

To initialize the settings of Controller, it is necessary to initialize CPU Unit.
Change the operating mode of Controller to PROGRAM mode before the initialization. Select **Clear All Memory** from the Controller Menu in Sysmac Studio. The Clear All Memory Dialog Box is displayed. Check the contents and click **OK**.

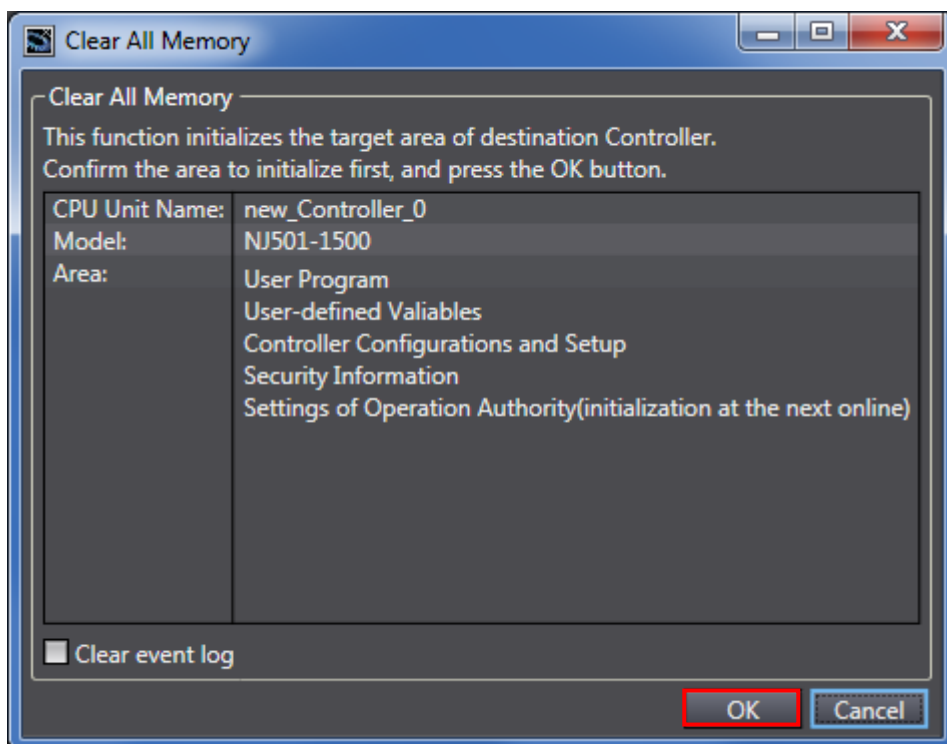

8.2. Initializing Inverter

For information on how to initialize Inverter, refer to *5-1-2 Parameter Initialization* of the *Inverter Multi-function Compact Inverter MX2 Series Type V1 User's Manual* (Cat. No. I585).

9. Revision History

Revision code	Date of revision	Revision reason and revision page
01	September 18, 2015	First edition

OMRON Corporation Industrial Automation Company

Tokyo, JAPAN

Contact: www.ia.omron.com

Regional Headquarters

OMRON EUROPE B.V.

Wegalaan 67-69, 2132 JD Hoofddorp
The Netherlands
Tel: (31)2356-81-300/Fax: (31)2356-81-388

OMRON ELECTRONICS LLC

2895 Greenspoint Parkway, Suite 200
Hoffman Estates, IL 60169 U.S.A
Tel: (1) 847-843-7900/Fax: (1) 847-843-7787

OMRON ASIA PACIFIC PTE. LTD.

No. 438A Alexandra Road # 05-05/08 (Lobby 2),
Alexandra Technopark,
Singapore 119967
Tel: (65) 6835-3011/Fax: (65) 6835-2711

OMRON (CHINA) CO., LTD.

Room 2211, Bank of China Tower,
200 Yin Cheng Zhong Road,
PuDong New Area, Shanghai, 200120, China
Tel: (86) 21-5037-2222/Fax: (86) 21-5037-2200

Authorized Distributor:

© OMRON Corporation 2015 All Rights Reserved.
In the interest of product improvement,
specifications are subject to change without notice.

Cat. No. P640-E1-01

0915- (-)