

Machine Automation Controller NJ-series

# EtherCAT<sup>®</sup> Connection Guide

## OMRON Corporation

Digital Sensor Communication Unit  
(E3NW-ECT)

Network  
Connection  
Guide

### **About Intellectual Property Right and Trademarks**

---

Microsoft product screen shots reprinted with permission from Microsoft Corporation.

Windows is a registered trademark of Microsoft Corporation in the USA and other countries.

Sysmac is a trademark or registered trademark of OMRON Corporation in Japan and other countries for OMRON factory automation products.

EtherCAT® is registered trademark and patented technology, licensed by Beckhoff Automation GmbH, Germany.

Ethernet is a registered trademark of Xerox Corporation.

Company names and product names in this document are the trademarks or registered trademarks of their respective companies.

---

## Table of Contents

<b>1. Related Manuals</b> .....	<b>1</b>
<b>2. Terms and Definitions</b> .....	<b>2</b>
<b>3. Remarks</b> .....	<b>3</b>
<b>4. Overview</b> .....	<b>4</b>
<b>5. Applicable Devices and Support Software</b> .....	<b>4</b>
5.1. Applicable Devices .....	4
5.2. Device Configuration.....	5
<b>6. EtherCAT Settings</b> .....	<b>7</b>
6.1. EtherCAT Communications Setting.....	7
6.2. DS-Bus Communication Settings.....	7
6.3. Allocation of EtherCAT Communications .....	9
<b>7. Connection Procedure</b> .....	<b>11</b>
7.1. Work Flow .....	11
7.2. Setting Up the Digital Sensor Communication Unit.....	12
7.3. Setting Up the Controller.....	14
7.4. Checking the EtherCAT Communications .....	23
<b>8. Initialization Method</b> .....	<b>29</b>
8.1. Initializing the Controller.....	29
<b>9. Revision History</b> .....	<b>30</b>

## 1. Related Manuals

The table below lists the manuals related to this document.

To ensure system safety, make sure to always read and heed the information provided in all Safety Precautions, Precautions for Safe Use, and Precaution for Correct Use of manuals for each device which is used in the system.

Cat. No.	Model	Manual name
W500	NJ501-□□□□ NJ301-□□□□	NJ-series CPU Unit Hardware User's Manual
W501	NJ501-□□□□ NJ301-□□□□	NJ-series CPU Unit Software User's Manual
W505	NJ501-□□□□ NJ301-□□□□	NJ-series CPU Unit Built-in EtherCAT® Port User's Manual
W504	SYSMAC-SE2□□□□	Sysmac Studio Version 1 Operation Manual
E429	E3NW-ECT E3NW-DS	EtherCAT® Digital Sensor Communication Unit Operation Manual



## 2. Terms and Definitions

Term	Explanation and Definition
PDO communications (Communications using Process Data Objects)	<p>This method is used for cyclic data exchange between the master unit and the slave units.</p> <p>PDO data (i.e., I/O data that is mapped to PDOs) that is allocated in advance is refreshed periodically each EtherCAT process data communications cycle (i.e., the period of primary periodic task).</p> <p>The NJ-series Machine Automation Controller uses the PDO communications for commands to refresh I/O data in a fixed control period, including I/O data for EtherCAT Slave Units, and the position control data for the Servomotors.</p> <p>It is accessed from the NJ-series Machine Automation Controller in the following ways.</p> <ul style="list-style-type: none"> <li>•With device variables for EtherCAT slave I/O</li> <li>•With Axis Variables for Servo Drive and encoder input slaves to which assigned as an axis</li> </ul>
SDO Communications (Communications using Service Data Objects)	<p>This method is used to read and write the specified slave unit data from the master unit when required.</p> <p>The NJ-series Machine Automation Controller uses SDO communications for commands to read and write data, such as for parameter transfers, at specified times.</p> <p>The NJ-series Machine Automation Controller can read/write the specified slave data (parameters and error information, etc.) with the EC_CoESDORead (Read CoE SDO) instruction or the EC_CoESDOWrite (Write CoE SDO) instruction.</p>
Slave Unit	<p>There are various types of slaves such as Servo Drives that handle position data and I/O terminals that handle the bit signals.</p> <p>The slave unit receives output data sent from the master, and transmits input data to the master.</p>
Node address	<p>An address to identify the unit connected to EtherCAT.</p>
ESI file (EtherCAT Slave Information file)	<p>The ESI files contain information unique to the EtherCAT slaves in XML format.</p> <p>Install an ESI file into the Sysmac Studio, to allocate slave process data and make other settings.</p>

### 3. Remarks

- (1) Understand the specifications of devices which are used in the system. Allow some margin for ratings and performance. Provide safety measures, such as installing safety circuit in order to ensure safety and minimize risks of abnormal occurrence.
- (2) To ensure system safety, always read and heed the information provided in all Safety Precautions, Precautions for Safe Use, and Precaution for Correct Use of manuals for each device used in the system.
- (3) The users are encouraged to confirm the standards and regulations that the system must conform to.
- (4) It is prohibited to copy, to reproduce, and to distribute part or the whole of this document without the permission of OMRON Corporation.
- (5) The information contained in this document is current as of May 2013. It is subject to change without notice for improvement.

The following notation is used in this document.

 <b>WARNING</b>	Indicates a potentially hazardous situation which, if not avoided, will result in minor or moderate injury, or may result in serious injury or death. Additionally there may be significant property damage.
 <b>Caution</b>	Indicates a potentially hazardous situation which, if not avoided, may result in minor or moderate injury or in property damage.



#### Precautions for Safe Use

Precautions on what to do and what not to do to ensure safe usage of the product.



#### Precautions for Correct Use

Precautions on what to do and what not to do to ensure proper operation and performance.



#### Additional Information

Additional information to read as required.

This information is provided to increase understanding or make operation easier.

### Symbols



The filled circle symbol indicates operations that you must do.  
The specific operation is shown in the circle and explained in text.  
This example shows a general precaution for something that you must do.

## 4. Overview

This document describes the procedure for connecting the Digital Sensor Communication Unit (E3NW-ECT) of OMRON Corporation (hereinafter referred to as OMRON) to NJ-series Machine Automation Controller (hereinafter referred to as the Controller) via EtherCAT and provides the procedure for checking their connection.

Refer to EtherCAT settings described in 7. Connection Procedure to understand the setting method and key points to connect the devices via EtherCAT.

## 5. Applicable Devices and Support Software

### 5.1. Applicable Devices

The applicable devices are as follows:

Manufacturer	Name	Model
OMRON	NJ-series CPU Unit	NJ501-□□□□ NJ301-□□□□
OMRON	Digital Sensor Communication Unit	E3NW-ECT
OMRON	Distributed Sensor Unit	E3NW-DS
OMRON	Sensor Amplifiers Smart Fiber Amplifier Smart Laser Amplifier Unit Smart Laser Amplifier Unit (CMOS Type)	E3NX-FA0 E3NC-LA0 E3NC-SA0



#### Precautions for Correct Use

As applicable devices above, the devices with the models and versions listed in Section 5.2. are actually used in this document to describe the procedure for connecting devices and checking the connection.

You cannot use devices with versions lower than the versions listed in Section 5.2.

To use the above devices with versions not listed in Section 5.2 or versions higher than those listed in Section 5.2, check the differences in the specifications by referring to the manuals before operating the devices.



#### Additional Information

This document describes the procedure to establish the network connection. Except for the connection procedure, it does not provide information on operation, installation or wiring method. It also does not describe the functionality or operation of the devices. Refer to the manuals or contact your OMRON representative.

**5.2. Device Configuration**

The hardware components to reproduce the connection procedure of this document are as follows:

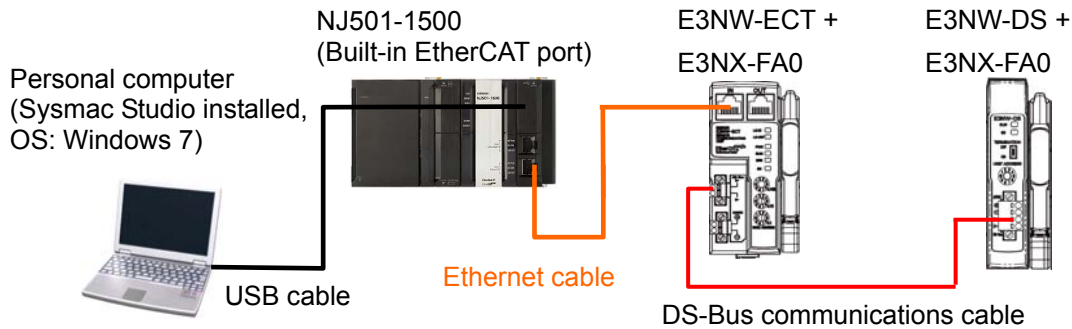

Manufacturer	Name	Model	Version
OMRON	CPU Unit (Built-in EtherCAT port)	NJ501-1500	Ver.1.04
OMRON	Power Supply Unit	NJ-PA3001	
OMRON	Sysmac Studio	SYSMAC-SE2□□□□	Ver.1.05
-	Personal computer (OS: Windows7)	-	
-	USB cable (USB 2.0 type B connector)	-	
OMRON	Ethernet cable (with industrial Ethernet connector)	XS5W-T421-□M□-K	
OMRON	Digital Sensor Communication Unit	E3NW-ECT	Ver.1.0
OMRON	Distributed Sensor Unit	E3NW-DS	Ver.1.0
OMRON	Fiber Amplifier	E3NX-FA0	Ver.1.0
-	DS-Bus communications cable	-	

**Precautions for Correct Use**

The connection line of EtherCAT communication cannot be shared with other Ethernet networks.

Make sure to directly connect the Controller to the destination device with the Ethernet cable. Please use the cable (double shielding with aluminum tape and braiding) of Category 5 or higher, and use the shielded connector of Category 5 or higher.

Connect the cable shield to the connector hood at both ends of the cable.

**Precautions for Correct Use**

Update the Sysmac Studio to the version specified in this section or higher version using the auto update function.

If a version not specified in this section is used, the procedures described in Section 7 and subsequent sections may not be applicable. In that case, use the equivalent procedures described in the Sysmac Studio Version 1 Operation Manual (Cat. No. W504).





### **Additional Information**

---

For information on the specifications of the Ethernet cable and network wiring, refer to *Section 4 EtherCAT Network Wiring* of the *NJ-series CPU Unit Built-in EtherCAT® Port User's Manual* (Cat. No. W505).

---



### **Additional Information**

---

The system configuration in this document uses USB for the connection to the Controller. For information on how to install a USB driver, refer to *A-1 Driver Installation for Direct USB Cable Connection* of the *Sysmac Studio Version 1 Operation Manual* (Cat. No. W504).

---



### **Additional Information**

---

For details on the Inter-Unit DS-Bus network, refer to *A-2 Using Distributed Sensor Units* of the *EtherCAT® Digital Sensor Communication Unit Operation Manual* (Cat. No. E429).

---

## 6. EtherCAT Settings

This section describes the specifications such as communication parameters and variables that are defined in this document.

Hereinafter, the Digital Sensor Communication Unit is referred to as the "destination device" or the "Slave Unit" in some descriptions.

### 6.1. EtherCAT Communications Setting

The setting required for communications between the Controller and the Digital Sensor Communication Unit is given below.

#### 6.1.1. EtherCAT Communications Setting Content

The setting required for EtherCAT communications is given below.

	Digital Sensor Communication Unit
Node address	001

### 6.2. DS-Bus Communication Settings

The setting required for communications between the Digital Sensor Communication Unit and the Distributed Sensor Unit is given below.

#### 6.2.1. DS-Bus Communication Setting Contents

The settings required for communications through the Inter-Unit DS-Bus network are given below.

	Distributed Sensor Unit
Unit address	1
Termination setting	ON

\*The Sensor unit numbers are automatically assigned after turning ON the power supply to the Digital Sensor Communication Unit and to the Distributed Sensor Unit.

In this document, one Fiber Amplifier is connected to the Digital Sensor Communication Unit and another one to the Distributed Sensor Unit. The Sensor unit number 1 is assigned to the Fiber Amplifier that is connected to the Digital Sensor Communication Unit, and the Sensor unit number 2 is assigned to the Fiber Amplifier connected to the Distributed Sensor Unit.



#### Additional Information

For details on the Inter-Unit DS-Bus network, refer to A-2 *Using Distributed Sensor Units of the EtherCAT® Digital Sensor Communication Unit Operation Manual* (Cat. No. E429).

### 6.2.2. Cable Wiring Diagram

For details on the cable wiring, refer to A-2-3 DS-Bus Network Wiring of the EtherCAT® Digital Sensor Communication Unit Operation Manual (Cat. No. E429). Check the connector configuration and pin assignment for wiring.

■ Connector configuration and pin assignment

<OMRON E3NW-ECT> Applicable connector: Terminal-block connector

Pin No.	Name	Description	I/O
1	D+	D+ terminal	I/O
2	D-	D- terminal	I/O

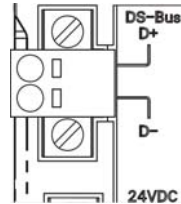

<OMRON E3NW-DS> Applicable connector: Terminal-block connector

Pin No.	Name	Description	I/O
1	⊕	+V terminal	-
2	⊖	-V terminal	-
3	D+	D+ terminal	I/O
4	D-	D- terminal	I/O

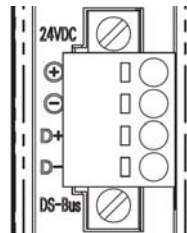

■ Cable/Pin arrangement

Digital Sensor Communication Unit (E3NW-ECT)		
DS-Bus	Signal name	Pin No.
	D+	1
	D-	2
Terminal-block connector		

Distributed Sensor Unit (E3NW-DS)		
Pin No.	Signal name	DS-Bus
1	⊕	
2	⊖	
3	D+	
4	D-	
Terminal-block connector		

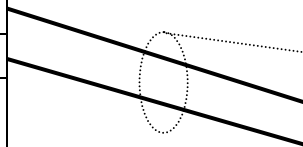

**Additional Information**

For details on the recommended cables and ferrules, refer to A-2-3 DS-Bus Network Wiring of the EtherCAT® Digital Sensor Communication Unit Operation Manual (Cat. No. E429).

### 6.3. Allocation of EtherCAT Communications

The device variables for the destination device are allocated to the global variables for the Controller.

The relationship between the device data and the global variables is shown below.

■ Output area (Controller → Destination device)

No global variable for the Controller is allocated.

■ Input area 1 (Controller ← Destination device)

Device variable name	Data type	Meaning
E001_Read_input_1st_word	WORD	Input bits 00 to 15
E001_In_Bit00	BOOL	Input bit 00
E001_In_Bit01	BOOL	Input bit 01
E001_In_Bit02	BOOL	Input bit 02
E001_In_Bit03	BOOL	Input bit 03
E001_In_Bit04	BOOL	Input bit 04
E001_In_Bit05	BOOL	Input bit 05
E001_In_Bit06	BOOL	Input bit 06
E001_In_Bit07	BOOL	Input bit 07
E001_In_Bit08	BOOL	Input bit 08
E001_In_Bit09	BOOL	Input bit 09
E001_In_Bit10	BOOL	Input bit 10
E001_In_Bit11	BOOL	Input bit 11
E001_In_Bit12	BOOL	Input bit 12
E001_In_Bit13	BOOL	Input bit 13
E001_In_Bit14	BOOL	Input bit 14
E001_In_Bit15	BOOL	Input bit 15

■ Input area 2 (Controller ← Destination device)

Device variable name	Data type	Meaning
E001_Read_input_2nd_word	WORD	Input bits 16 to 31
E001_In_Bit16	BOOL	Input bit 16
E001_In_Bit17	BOOL	Input bit 17
E001_In_Bit18	BOOL	Input bit 18
E001_In_Bit19	BOOL	Input bit 19
E001_In_Bit20	BOOL	Input bit 20
E001_In_Bit21	BOOL	Input bit 21
E001_In_Bit22	BOOL	Input bit 22
E001_In_Bit23	BOOL	Input bit 23
E001_In_Bit24	BOOL	Input bit 24
E001_In_Bit25	BOOL	Input bit 25
E001_In_Bit26	BOOL	Input bit 26
E001_In_Bit27	BOOL	Input bit 27
E001_In_Bit28	BOOL	Input bit 28
E001_In_Bit29	BOOL	Input bit 29
E001_In_Bit30	BOOL	Input bit 30
E001_In_Bit31	BOOL	Input bit 31

■ Input area 3 (Controller ← Destination device)

Device variable name	Data type	Meaning
E001_No_01_Detection_Level_IN1	INT	Unit No. 1 Sensor detection level input 1
E001_No_02_Detection_Level_IN1	INT	Unit No. 2 Sensor detection level input 1
E001_No_03_Detection_Level_IN1	INT	Unit No. 3 Sensor detection level input 1
E001_No_04_Detection_Level_IN1	INT	Unit No. 4 Sensor detection level input 1
E001_No_05_Detection_Level_IN1	INT	Unit No. 5 Sensor detection level input 1
E001_No_06_Detection_Level_IN1	INT	Unit No. 6 Sensor detection level input 1
E001_No_07_Detection_Level_IN1	INT	Unit No. 7 Sensor detection level input 1
E001_No_08_Detection_Level_IN1	INT	Unit No. 8 Sensor detection level input 1

■ Details of the status allocation 1 (Controller ← Destination device)

Device variable name	Data type	Meaning
E001_Sensor_Communication_Status	BYTE	Sensor communication status 8 bits
E001_Sensor_Communication_Busy	BOOL	Sensor communication busy
E001_Sensor_Communication_Error	BOOL	Sensor communication error
E001_Number_of_Sensors_Setting	USINT	Number of Sensors setting
E001_Number_of_Sensors_with_Dummy	USINT	Number of Sensors setting with dummy
E001_Sensor_Warning_Status	DWORD	Sensor warning status

■ Details of the status allocation 2 (Controller ← Destination device)

Device variable name	Data type	Meaning
E001_Sysmac_Error_Status	BYTE	Sysmac error status
E001_Observation	BOOL	Details on observation level error
E001_Minor_Fault	BOOL	Details on minor fault level error

## 7. Connection Procedure

This section describes the procedure for connecting the Controller to the Digital Sensor Communication Unit via EtherCAT.

This document explains the procedure for setting up the Controller and the Digital Sensor Communication Unit from the factory default setting. For the initialization, refer to *Section 8 Initialization Method*.

### 7.1. Work Flow

Take the following steps to connect to EtherCAT.

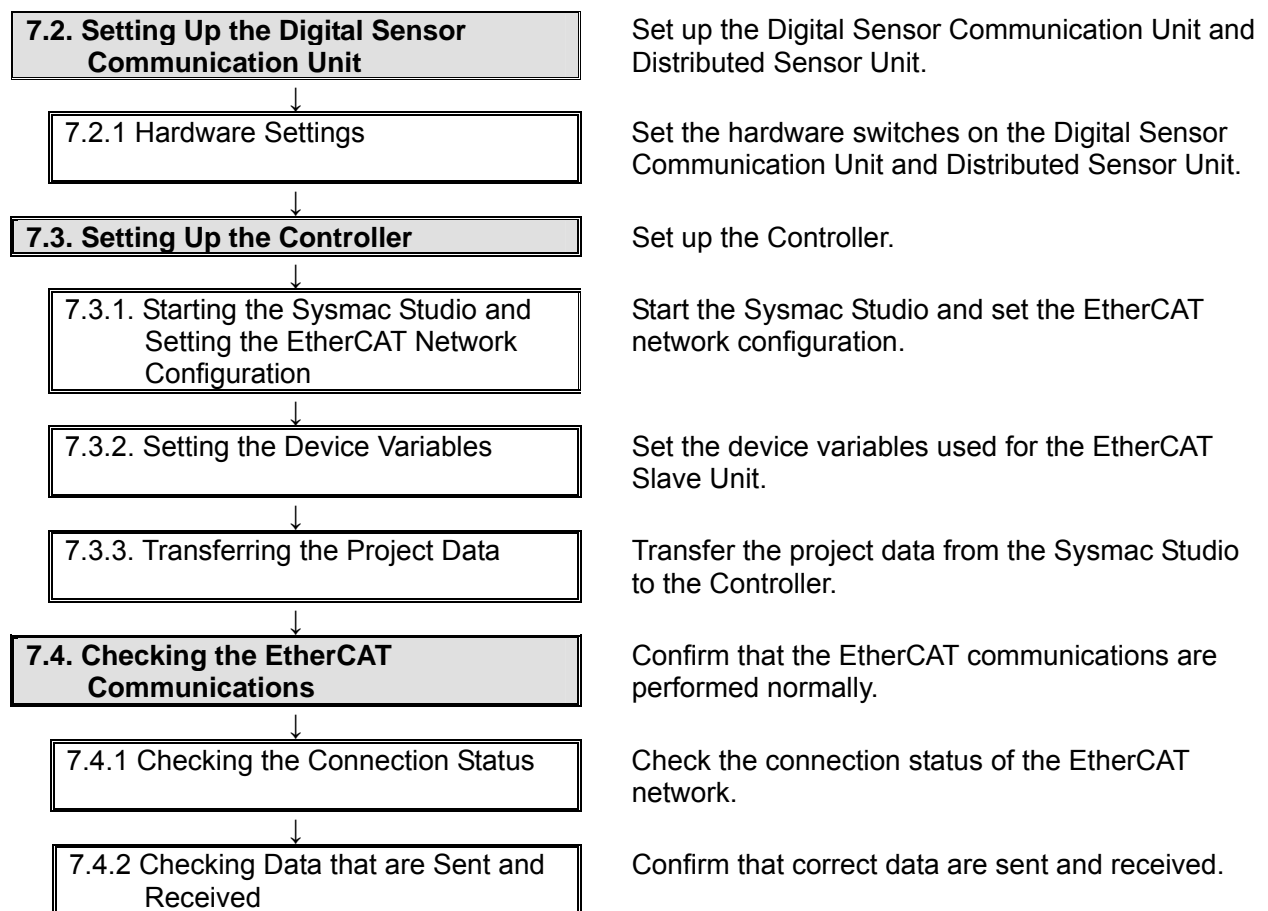

## 7.2. Setting Up the Digital Sensor Communication Unit

Set Up the Digital Sensor Communication Unit.

### 7.2.1. Hardware Settings

Set the hardware switches on the Digital Sensor Communication Unit.



#### Precautions for Correct Use

Make sure that the power supply is OFF when you perform the setting up.

- 1 Confirm that the power supply to the Digital Sensor Communication Unit is OFF.

\*If the power supply is turned ON, settings may not be applicable as described in the following procedure.

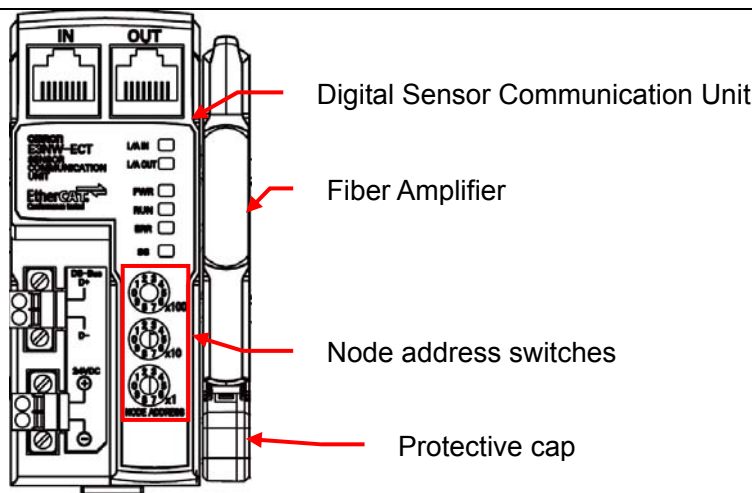

- 2 Connect the Digital Sensor Communication Unit to the Fiber Amplifier, and attach the protective cap. Check the hardware switches on the Digital Sensor Communication Unit by referring to the figure on the right.

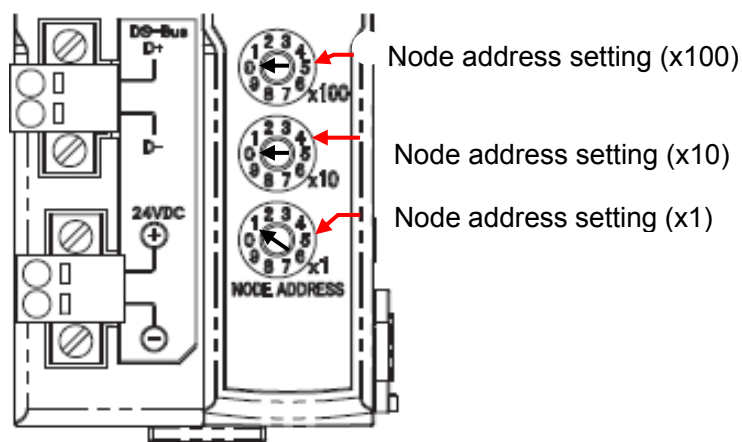

- 3 Set the node address switches as follows:  
 ×100: 0  
 ×10: 0  
 ×1: 1

\*Set the node address to 001.

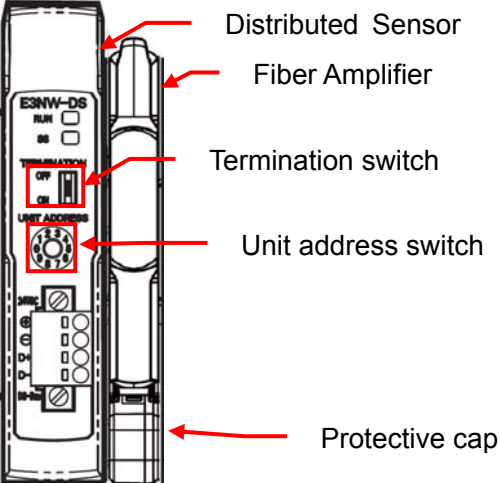

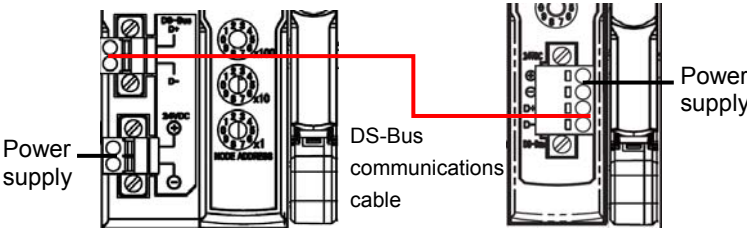
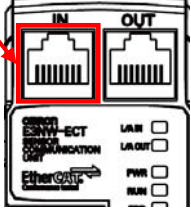
<p>4</p>	<p>Connect the Distributed Sensor Unit to the Fiber Amplifier, and attach the protective cap. Check the hardware switches on the Distributed Sensor Unit by referring to the figure on the right.</p>	 <p>Distributed Sensor Fiber Amplifier Termination switch Unit address switch Protective cap</p>
<p>5</p>	<p>Set the termination switch to ON.</p>	 <p>Termination switch</p> <p>This switch turns ON and OFF the communications terminating resistance on the Inter-Unit DS-Bus network. Turn ON the DS-Bus termination switch only on the last Distributed Sensor Unit on the DS-Bus network. Turn it OFF on all other Distributed Sensor Units.</p>
<p>6</p>	<p>Set the unit address switch to 1.  *Set the unit address to 1.</p>	 <p>Unit address setting</p> <p>This switch sets the node address (decimal) that the E3NW-DS will use on the Inter-Unit DS-Bus network. The setting range is from 1 to 8. (Default setting: 1) If you connect more than one Distributed Sensor Unit to the Sensor Communication Unit, set the address for each Distributed Sensor Unit to consecutive numbers starting from 1.</p>
<p>7</p>	<p>Connect the Digital Sensor Communication Unit to the Distributed Sensor Unit with the DS-Bus communications cable.  *For the wiring of the DS-Bus communications cable, refer to 6.2.2. Cable Wiring Diagram.</p>	 <p>Power supply DS-Bus communications cable Power supply</p>
<p>8</p>	<p>Connect the Ethernet cable to CN IN connector.  Turn ON the power supply.  Unit numbers are assigned to the Fiber Amplifier as follows after turning ON the power supply. Digital Sensor Communication Unit: Sensor unit No. 1 Distributed Sensor Unit: Sensor unit No. 2</p>	 <p>CN IN connector</p>



### 7.3. Setting Up the Controller

Set up the Controller.

#### 7.3.1. Starting the Sysmac Studio and Setting the EtherCAT Network Configuration

Start the Sysmac Studio and set the EtherCAT network configuration.

Install the Sysmac Studio and USB driver in the personal computer beforehand.

- 1 Connect the Ethernet cable to the built-in EtherCAT port (PORT2) of the Controller and connect the USB cable to the peripheral (USB) port. Connect the personal computer, Digital Sensor Communication Unit and Controller as shown in 5.2. Device Configuration. Turn ON the power supply to the Controller.

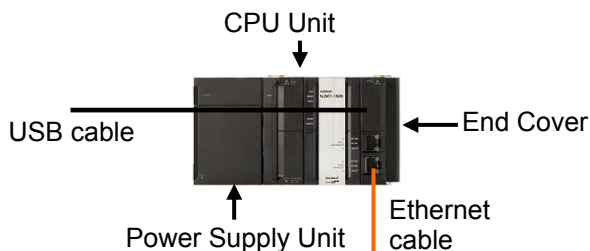

- 2 Start the Sysmac Studio. Click the **New Project** Button.

\*If a confirmation dialog for an access right is displayed at start, select to start.

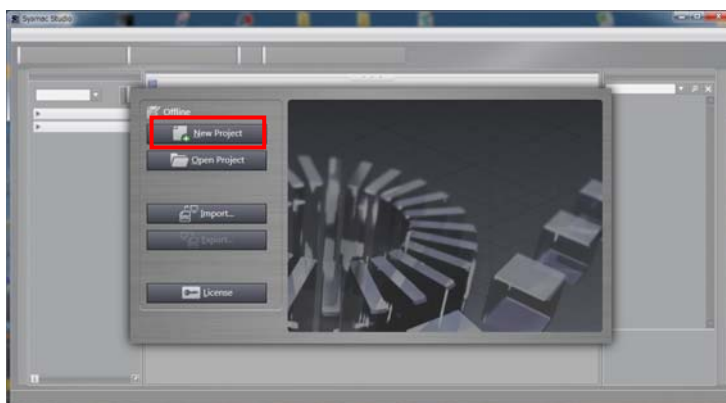

- 3 The Project Properties Dialog Box is displayed. \*In this document, New Project is set as the project name.

Confirm that Category and Device to use are set in the Select Device Field.

Select version 1.04 from the pull-down list of Version.

\*Although 1.04 is selected in this document, select a version you actually use.

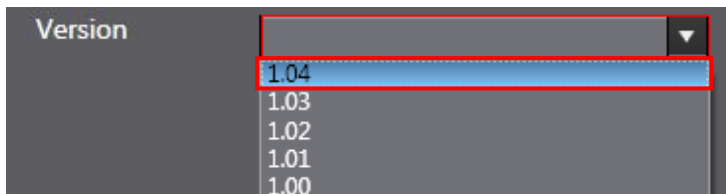
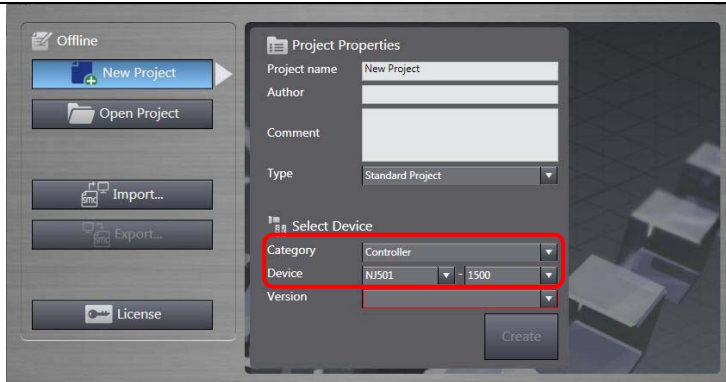

- 4 Click the **Create** Button.

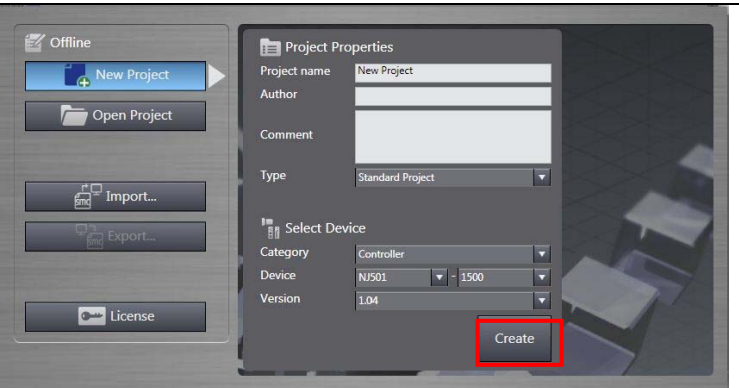
- 5 The New Project is displayed. The left pane is called Multiview Explorer, the right pane is called Toolbox and the middle pane is called Edit Pane.

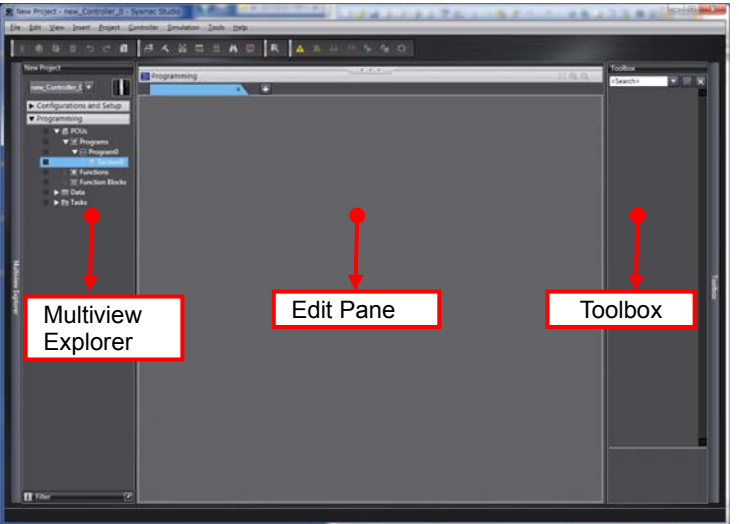
- 6 Double-click **EtherCAT** under **Configurations and Setup** in the Multiview Explorer.

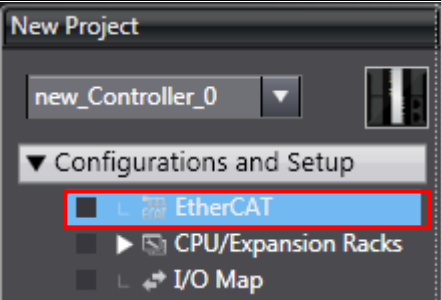

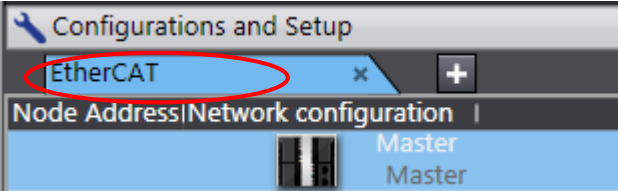
- 7 The EtherCAT Tab is displayed on the Edit Pane.

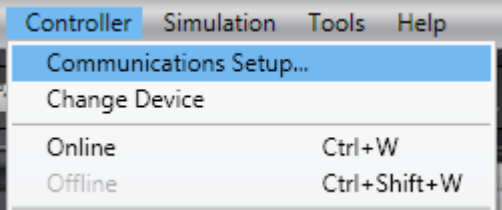
- 8 Select **Communications Setup** from the Controller Menu.

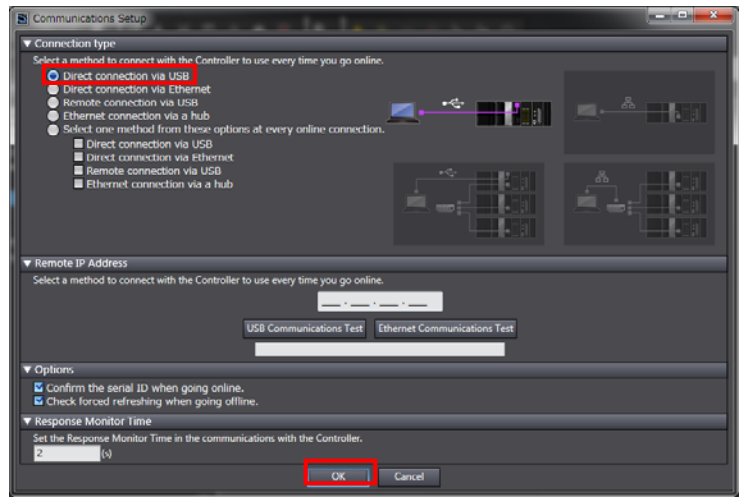

9 The Communications Setup Dialog Box is displayed. Select the *Direct connection via USB* Option for Connection Type.

Click the **OK** Button.



10 Select **Online** from the Controller Menu. If a confirmation dialog is displayed, check the message on the dialog and if there is no problem, click the **Yes** Button.

\*The displayed dialog depends on the status of the Controller used. Click the **Yes** Button to proceed with the processing.

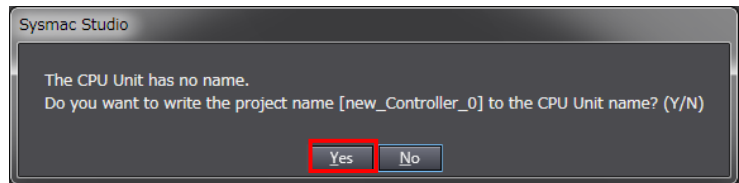
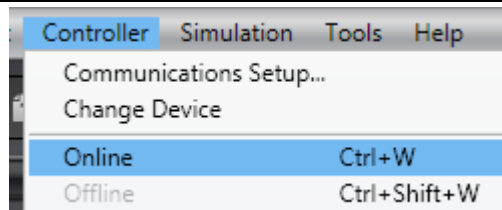

11 When an online connection is established, a yellow bar is displayed on the top of the Edit Pane.



**Additional Information**

For details on online connections to a Controller, refer to *Section 5 Online Connections to a Controller* of the *Sysmac Studio Version 1 Operation Manual* (Cat. No. W504).

12 Right-click **Master** on the EtherCAT Tab Page, and select **Compare and Merge with Actual Network Configuration**.

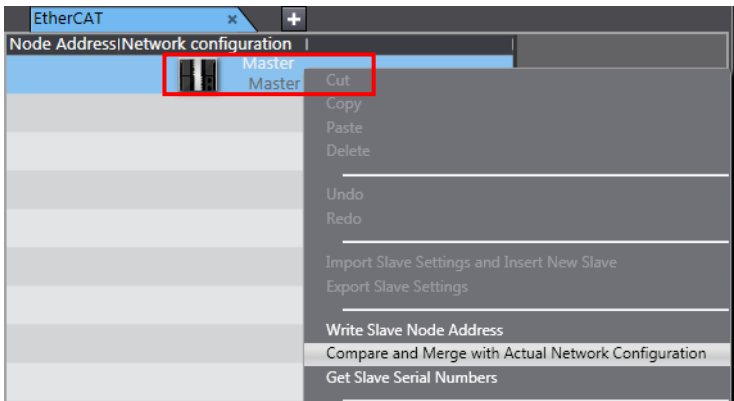

A screen is displayed stating "Get information is being executed".

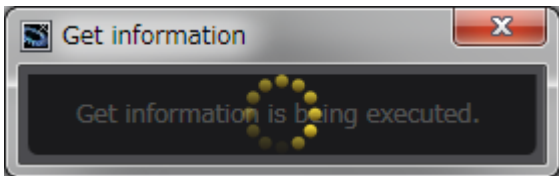

13 The Compare and Merge with Actual Network Configuration Pane is displayed. Node address 1 and E3NW-ECT Rev.1.0 are added to the Actual network configuration after the comparison. Click the **Apply actual network configuration** Button.

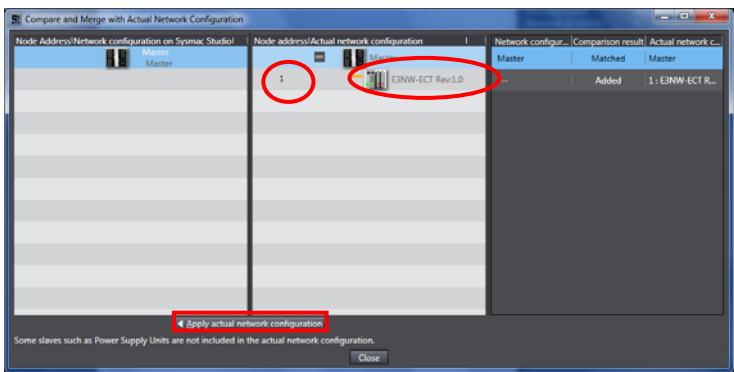

14 A confirmation dialog box is displayed. Check the message on the dialog and if there is no problem, click the **Apply** Button.

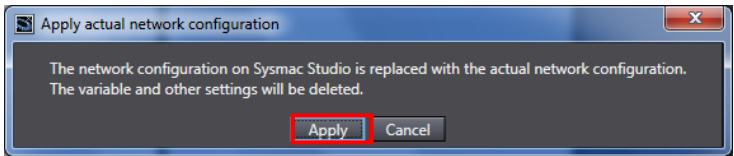

Confirm that node address 1 and E001 E3NW-ECT Rev.1.0 are added to the Network configuration on Sysmac Studio.

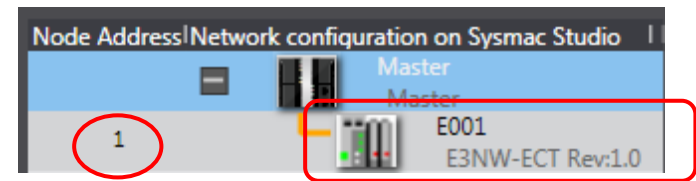

Confirm that they were added and click the **Close** Button.

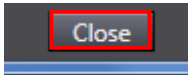

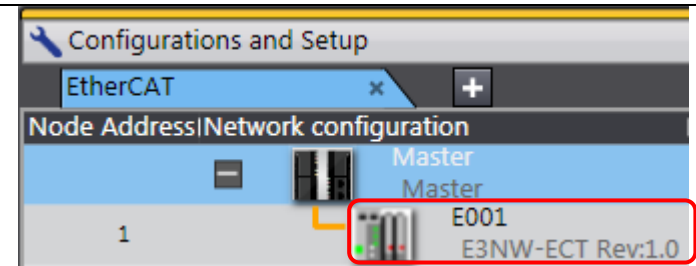

15 Node address 1 and E001 E3NW-ECT Rev.1.0 are added to the EtherCAT Tab Page in the Edit Pane.

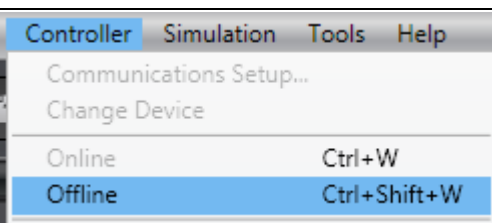

### 7.3.2. Setting the Device Variables

Set the device variables used for the EtherCAT Slave Unit.

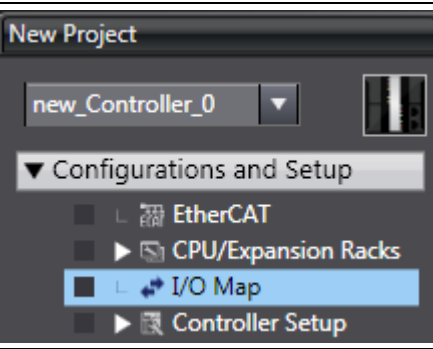
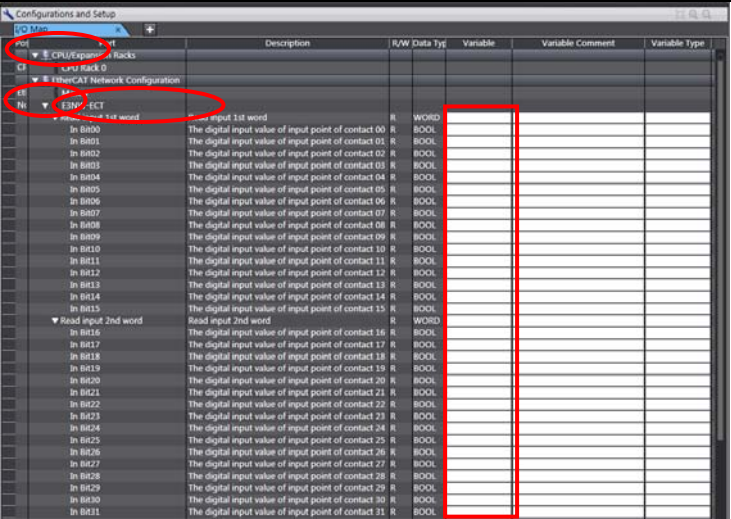
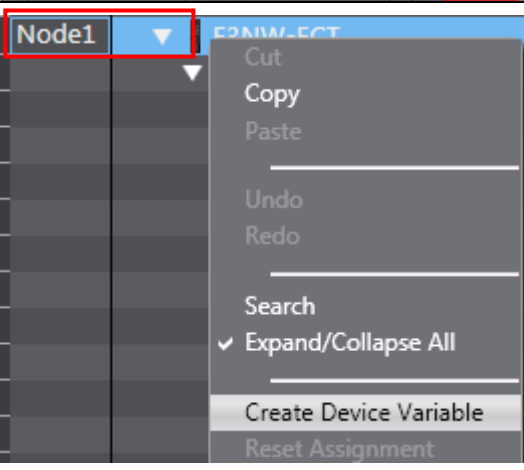
<p>1 Select <b>Offline</b> from the Controller Menu.</p> <p>The yellow bar on the top of the Edit Pane disappears.</p>	 <p style="text-align: center;">↓</p> 																																																																																																																																																																																																																																																					
<p>2 Double-click <b>I/O Map</b> under <b>Configurations and Setup</b> on the Multiview Explorer.</p>																																																																																																																																																																																																																																																						
<p>3 The I/O Map Tab is displayed on the Edit Pane.</p> <p>Confirm that Node1 is displayed in the Position Column and the Slave Unit is displayed.</p> <p>*To manually set a variable name for the Slave Unit, click a column under Variable Column and enter a name.</p>	 <table border="1" style="width: 100%; border-collapse: collapse;"> <thead> <tr> <th>Position</th> <th>Description</th> <th>R/W</th> <th>Data Typ</th> <th>Variable</th> <th>Variable Comment</th> <th>Variable Type</th> </tr> </thead> <tbody> <tr> <td>Node1</td> <td>ESW1-ECT</td> <td></td> <td></td> <td></td> <td></td> <td></td> </tr> <tr> <td>In 0000</td> <td>The digital input value of input point of contact 00</td> <td>R</td> <td>BOOL</td> <td></td> <td></td> <td></td> </tr> <tr> <td>In 0001</td> <td>The digital input value of input point of contact 01</td> <td>R</td> <td>BOOL</td> <td></td> <td></td> <td></td> </tr> <tr> <td>In 0002</td> <td>The digital input value of input point of contact 02</td> <td>R</td> <td>BOOL</td> <td></td> <td></td> <td></td> </tr> <tr> <td>In 0003</td> <td>The digital input value of input point of contact 03</td> <td>R</td> <td>BOOL</td> <td></td> <td></td> <td></td> </tr> <tr> <td>In 0004</td> <td>The digital input value of input point of contact 04</td> <td>R</td> <td>BOOL</td> <td></td> <td></td> <td></td> </tr> <tr> <td>In 0005</td> <td>The digital input value of input point of contact 05</td> <td>R</td> <td>BOOL</td> <td></td> <td></td> <td></td> </tr> <tr> <td>In 0006</td> <td>The digital input value of input point of contact 06</td> <td>R</td> <td>BOOL</td> <td></td> <td></td> <td></td> </tr> <tr> <td>In 0007</td> <td>The digital input value of input point of contact 07</td> <td>R</td> <td>BOOL</td> <td></td> <td></td> <td></td> </tr> <tr> <td>In 0008</td> <td>The digital input value of input point of contact 08</td> <td>R</td> <td>BOOL</td> <td></td> <td></td> <td></td> </tr> <tr> <td>In 0009</td> <td>The digital input value of input point of contact 09</td> <td>R</td> <td>BOOL</td> <td></td> <td></td> <td></td> </tr> <tr> <td>In 0010</td> <td>The digital input value of input point of contact 10</td> <td>R</td> <td>BOOL</td> <td></td> <td></td> <td></td> </tr> <tr> <td>In 0011</td> <td>The digital input value of input point of contact 11</td> <td>R</td> <td>BOOL</td> <td></td> <td></td> <td></td> </tr> <tr> <td>In 0012</td> <td>The digital input value of input point of contact 12</td> <td>R</td> <td>BOOL</td> <td></td> <td></td> <td></td> </tr> <tr> <td>In 0013</td> <td>The digital input value of input point of contact 13</td> <td>R</td> <td>BOOL</td> <td></td> <td></td> <td></td> </tr> <tr> <td>In 0014</td> <td>The digital input value of input point of contact 14</td> <td>R</td> <td>BOOL</td> <td></td> <td></td> <td></td> </tr> <tr> <td>In 0015</td> <td>The digital input value of input point of contact 15</td> <td>R</td> <td>BOOL</td> <td></td> <td></td> <td></td> </tr> <tr> <td>Read input 2nd word</td> <td>Read input 2nd word</td> <td></td> <td>WORD</td> <td></td> <td></td> <td></td> </tr> <tr> <td>In 0016</td> <td>The digital input value of input point of contact 16</td> <td>R</td> <td>BOOL</td> <td></td> <td></td> <td></td> </tr> <tr> <td>In 0017</td> <td>The digital input value of input point of contact 17</td> <td>R</td> <td>BOOL</td> <td></td> <td></td> <td></td> </tr> <tr> <td>In 0018</td> <td>The digital input value of input point of contact 18</td> <td>R</td> <td>BOOL</td> <td></td> <td></td> <td></td> </tr> <tr> <td>In 0019</td> <td>The digital input value of input point of contact 19</td> <td>R</td> <td>BOOL</td> <td></td> <td></td> <td></td> </tr> <tr> <td>In 0020</td> <td>The digital input value of input point of contact 20</td> <td>R</td> <td>BOOL</td> <td></td> <td></td> <td></td> </tr> <tr> <td>In 0021</td> <td>The digital input value of input point of contact 21</td> <td>R</td> <td>BOOL</td> <td></td> <td></td> <td></td> </tr> <tr> <td>In 0022</td> <td>The digital input value of input point of contact 22</td> <td>R</td> <td>BOOL</td> <td></td> <td></td> <td></td> </tr> <tr> <td>In 0023</td> <td>The digital input value of input point of contact 23</td> <td>R</td> <td>BOOL</td> <td></td> <td></td> <td></td> </tr> <tr> <td>In 0024</td> <td>The digital input value of input point of contact 24</td> <td>R</td> <td>BOOL</td> <td></td> <td></td> <td></td> </tr> <tr> <td>In 0025</td> <td>The digital input value of input point of contact 25</td> <td>R</td> <td>BOOL</td> <td></td> <td></td> <td></td> </tr> <tr> <td>In 0026</td> <td>The digital input value of input point of contact 26</td> <td>R</td> <td>BOOL</td> <td></td> <td></td> <td></td> </tr> <tr> <td>In 0027</td> <td>The digital input value of input point of contact 27</td> <td>R</td> <td>BOOL</td> <td></td> <td></td> <td></td> </tr> <tr> <td>In 0028</td> <td>The digital input value of input point of contact 28</td> <td>R</td> <td>BOOL</td> <td></td> <td></td> <td></td> </tr> <tr> <td>In 0029</td> <td>The digital input value of input point of contact 29</td> <td>R</td> <td>BOOL</td> <td></td> <td></td> <td></td> </tr> <tr> <td>In 0030</td> <td>The digital input value of input point of contact 30</td> <td>R</td> <td>BOOL</td> <td></td> <td></td> <td></td> </tr> <tr> <td>In 0031</td> <td>The digital input value of input point of contact 31</td> <td>R</td> <td>BOOL</td> <td></td> <td></td> <td></td> </tr> </tbody> </table>	Position	Description	R/W	Data Typ	Variable	Variable Comment	Variable Type	Node1	ESW1-ECT						In 0000	The digital input value of input point of contact 00	R	BOOL				In 0001	The digital input value of input point of contact 01	R	BOOL				In 0002	The digital input value of input point of contact 02	R	BOOL				In 0003	The digital input value of input point of contact 03	R	BOOL				In 0004	The digital input value of input point of contact 04	R	BOOL				In 0005	The digital input value of input point of contact 05	R	BOOL				In 0006	The digital input value of input point of contact 06	R	BOOL				In 0007	The digital input value of input point of contact 07	R	BOOL				In 0008	The digital input value of input point of contact 08	R	BOOL				In 0009	The digital input value of input point of contact 09	R	BOOL				In 0010	The digital input value of input point of contact 10	R	BOOL				In 0011	The digital input value of input point of contact 11	R	BOOL				In 0012	The digital input value of input point of contact 12	R	BOOL				In 0013	The digital input value of input point of contact 13	R	BOOL				In 0014	The digital input value of input point of contact 14	R	BOOL				In 0015	The digital input value of input point of contact 15	R	BOOL				Read input 2nd word	Read input 2nd word		WORD				In 0016	The digital input value of input point of contact 16	R	BOOL				In 0017	The digital input value of input point of contact 17	R	BOOL				In 0018	The digital input value of input point of contact 18	R	BOOL				In 0019	The digital input value of input point of contact 19	R	BOOL				In 0020	The digital input value of input point of contact 20	R	BOOL				In 0021	The digital input value of input point of contact 21	R	BOOL				In 0022	The digital input value of input point of contact 22	R	BOOL				In 0023	The digital input value of input point of contact 23	R	BOOL				In 0024	The digital input value of input point of contact 24	R	BOOL				In 0025	The digital input value of input point of contact 25	R	BOOL				In 0026	The digital input value of input point of contact 26	R	BOOL				In 0027	The digital input value of input point of contact 27	R	BOOL				In 0028	The digital input value of input point of contact 28	R	BOOL				In 0029	The digital input value of input point of contact 29	R	BOOL				In 0030	The digital input value of input point of contact 30	R	BOOL				In 0031	The digital input value of input point of contact 31	R	BOOL			
Position	Description	R/W	Data Typ	Variable	Variable Comment	Variable Type																																																																																																																																																																																																																																																
Node1	ESW1-ECT																																																																																																																																																																																																																																																					
In 0000	The digital input value of input point of contact 00	R	BOOL																																																																																																																																																																																																																																																			
In 0001	The digital input value of input point of contact 01	R	BOOL																																																																																																																																																																																																																																																			
In 0002	The digital input value of input point of contact 02	R	BOOL																																																																																																																																																																																																																																																			
In 0003	The digital input value of input point of contact 03	R	BOOL																																																																																																																																																																																																																																																			
In 0004	The digital input value of input point of contact 04	R	BOOL																																																																																																																																																																																																																																																			
In 0005	The digital input value of input point of contact 05	R	BOOL																																																																																																																																																																																																																																																			
In 0006	The digital input value of input point of contact 06	R	BOOL																																																																																																																																																																																																																																																			
In 0007	The digital input value of input point of contact 07	R	BOOL																																																																																																																																																																																																																																																			
In 0008	The digital input value of input point of contact 08	R	BOOL																																																																																																																																																																																																																																																			
In 0009	The digital input value of input point of contact 09	R	BOOL																																																																																																																																																																																																																																																			
In 0010	The digital input value of input point of contact 10	R	BOOL																																																																																																																																																																																																																																																			
In 0011	The digital input value of input point of contact 11	R	BOOL																																																																																																																																																																																																																																																			
In 0012	The digital input value of input point of contact 12	R	BOOL																																																																																																																																																																																																																																																			
In 0013	The digital input value of input point of contact 13	R	BOOL																																																																																																																																																																																																																																																			
In 0014	The digital input value of input point of contact 14	R	BOOL																																																																																																																																																																																																																																																			
In 0015	The digital input value of input point of contact 15	R	BOOL																																																																																																																																																																																																																																																			
Read input 2nd word	Read input 2nd word		WORD																																																																																																																																																																																																																																																			
In 0016	The digital input value of input point of contact 16	R	BOOL																																																																																																																																																																																																																																																			
In 0017	The digital input value of input point of contact 17	R	BOOL																																																																																																																																																																																																																																																			
In 0018	The digital input value of input point of contact 18	R	BOOL																																																																																																																																																																																																																																																			
In 0019	The digital input value of input point of contact 19	R	BOOL																																																																																																																																																																																																																																																			
In 0020	The digital input value of input point of contact 20	R	BOOL																																																																																																																																																																																																																																																			
In 0021	The digital input value of input point of contact 21	R	BOOL																																																																																																																																																																																																																																																			
In 0022	The digital input value of input point of contact 22	R	BOOL																																																																																																																																																																																																																																																			
In 0023	The digital input value of input point of contact 23	R	BOOL																																																																																																																																																																																																																																																			
In 0024	The digital input value of input point of contact 24	R	BOOL																																																																																																																																																																																																																																																			
In 0025	The digital input value of input point of contact 25	R	BOOL																																																																																																																																																																																																																																																			
In 0026	The digital input value of input point of contact 26	R	BOOL																																																																																																																																																																																																																																																			
In 0027	The digital input value of input point of contact 27	R	BOOL																																																																																																																																																																																																																																																			
In 0028	The digital input value of input point of contact 28	R	BOOL																																																																																																																																																																																																																																																			
In 0029	The digital input value of input point of contact 29	R	BOOL																																																																																																																																																																																																																																																			
In 0030	The digital input value of input point of contact 30	R	BOOL																																																																																																																																																																																																																																																			
In 0031	The digital input value of input point of contact 31	R	BOOL																																																																																																																																																																																																																																																			
<p>4 Right-click Node1 and select <b>Create Device Variable</b>.</p>																																																																																																																																																																																																																																																						

5 The variable names and variable types are automatically set.

Port	Description	I/R/W Data Typ	Variable	Variable Comm	Variable Type
3001_Read_input_1st_word	Read input 1st word	WORD	3001_Read_input_1st_word		Global Variables
In 8000	The digital input value of input point of contact 00	R	3001_in_8000		Global Variables
In 8001	The digital input value of input point of contact 01	R	3001_in_8001		Global Variables
In 8002	The digital input value of input point of contact 02	R	3001_in_8002		Global Variables
In 8003	The digital input value of input point of contact 03	R	3001_in_8003		Global Variables
In 8004	The digital input value of input point of contact 04	R	3001_in_8004		Global Variables
In 8005	The digital input value of input point of contact 05	R	3001_in_8005		Global Variables
In 8006	The digital input value of input point of contact 06	R	3001_in_8006		Global Variables
In 8007	The digital input value of input point of contact 07	R	3001_in_8007		Global Variables
In 8008	The digital input value of input point of contact 08	R	3001_in_8008		Global Variables
In 8009	The digital input value of input point of contact 09	R	3001_in_8009		Global Variables
In 8010	The digital input value of input point of contact 10	R	3001_in_8010		Global Variables
In 8011	The digital input value of input point of contact 11	R	3001_in_8011		Global Variables
In 8012	The digital input value of input point of contact 12	R	3001_in_8012		Global Variables
In 8013	The digital input value of input point of contact 13	R	3001_in_8013		Global Variables
In 8014	The digital input value of input point of contact 14	R	3001_in_8014		Global Variables
In 8015	The digital input value of input point of contact 15	R	3001_in_8015		Global Variables
3001_Read_input_2nd_word	Read input 2nd word	WORD	3001_Read_input_2nd_word		Global Variables
In 8016	The digital input value of input point of contact 16	R	3001_in_8016		Global Variables
In 8017	The digital input value of input point of contact 17	R	3001_in_8017		Global Variables
In 8018	The digital input value of input point of contact 18	R	3001_in_8018		Global Variables
In 8019	The digital input value of input point of contact 19	R	3001_in_8019		Global Variables
In 8020	The digital input value of input point of contact 20	R	3001_in_8020		Global Variables
In 8021	The digital input value of input point of contact 21	R	3001_in_8021		Global Variables
In 8022	The digital input value of input point of contact 22	R	3001_in_8022		Global Variables
In 8023	The digital input value of input point of contact 23	R	3001_in_8023		Global Variables
In 8024	The digital input value of input point of contact 24	R	3001_in_8024		Global Variables
In 8025	The digital input value of input point of contact 25	R	3001_in_8025		Global Variables
In 8026	The digital input value of input point of contact 26	R	3001_in_8026		Global Variables



**Additional Information**

The device variables are named automatically from a combination of the device names and the I/O port names.

For slave units, the default device names start with an "E" followed by a sequential number starting from "001".



**Additional Information**

In the example above, all device variables of the slave are automatically created. However, a device variable of each I/O port can also be automatically created.

Also, you can set any device variables manually.

### 7.3.3. Transferring the Project Data

Transfer the project data from the Sysmac Studio to the Controller.

⚠ **WARNING**



Always confirm safety at the destination node before you transfer a user program, configuration data, setup data, device variables, or values in memory used for CJ-series Units from the Sysmac Studio.

The devices or machines may perform unexpected operation regardless of the operating mode of the CPU Unit.

#### Precautions for Safe Use

After you transfer the user program, the CPU Unit restarts and communications with the EtherCAT slaves are cut off. During that period, the slave outputs behave according to the slave settings. The time that communications are cut off depends on the EtherCAT network configuration.

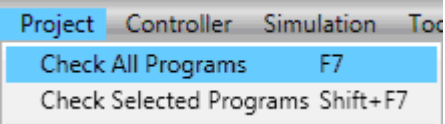
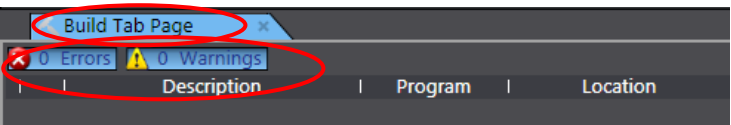
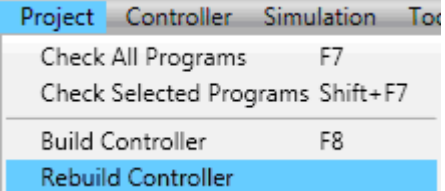
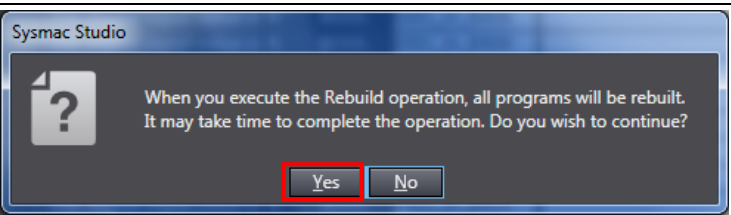
Before you transfer the user program, confirm that the system will not be adversely affected.

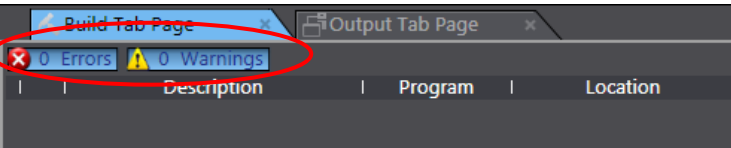
1	Select <b>Check All Programs</b> from the Project Menu.	
2	The Build Tab Page is displayed in the Edit Pane. Confirm that "0 Errors" and "0 Warnings" are displayed.	
3	Select <b>Rebuild Controller</b> from the Project Menu.	
4	A confirmation dialog is displayed. Check the message on the dialog and if there is no problem, click the <b>Yes</b> Button.  Confirm that "0 Errors" and "0 Warnings" are displayed in the Build Tab Page.	  

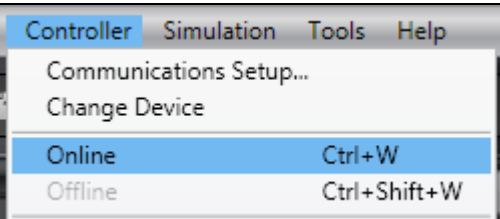
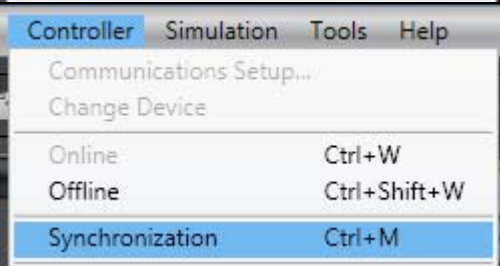
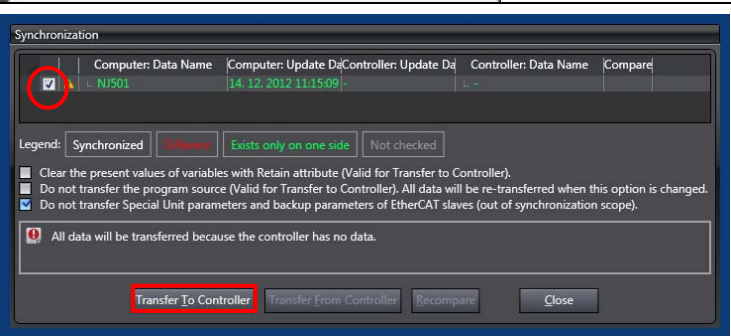
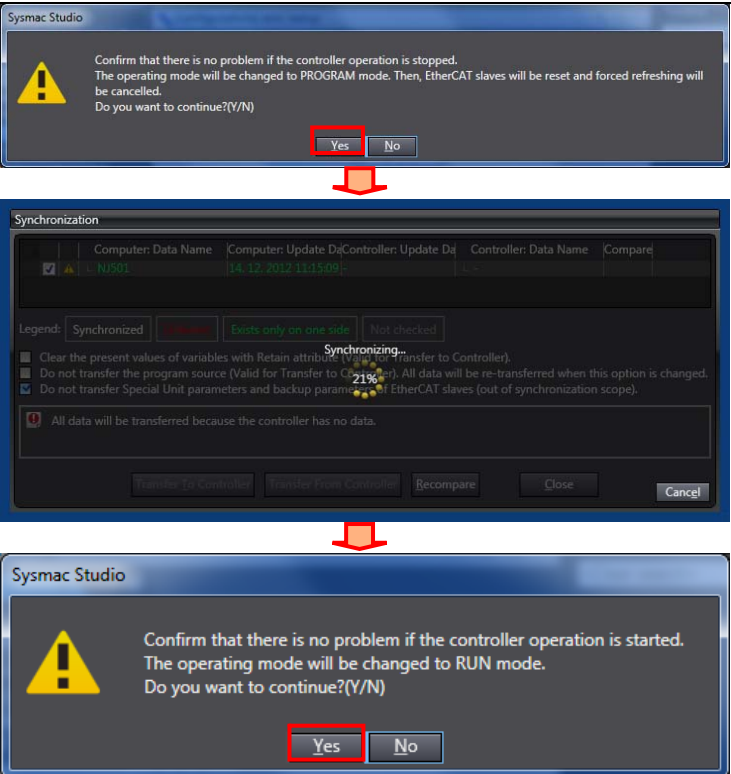
<p>5 Select <b>Online</b> from the Controller Menu.</p>	
<p>6 Select <b>Synchronization</b> from the Controller Menu.</p>	
<p>7 The Synchronization Dialog Box is displayed. Confirm that the data to transfer (NJ501 in the right dialog) is selected. Then, click the <b>Transfer to Controller</b> Button.</p> <p>*After executing the Transfer to Controller, the Sysmac Studio data is transferred to the Controller and the data are compared.</p>	
<p>8 A confirmation dialog is displayed. Check the message on the dialog and if there is no problem, click the <b>Yes</b> Button.</p> <p>A screen stating "Synchronizing" is displayed.</p> <p>A confirmation dialog is displayed. Check the message on the dialog and if there is no problem, click the <b>Yes</b> Button.</p>	



- 9 Confirm that the synchronized data is displayed with the color specified by "Synchronized", and that a message is displayed stating "The synchronization process successfully finished".

If there is no problem, click the **Close** Button.

\*A message stating "The synchronization process successfully finished" is displayed if the Sysmac Studio project data and the data in the Controller match.

\*If the synchronization fails, check the wiring and repeat from step 1.

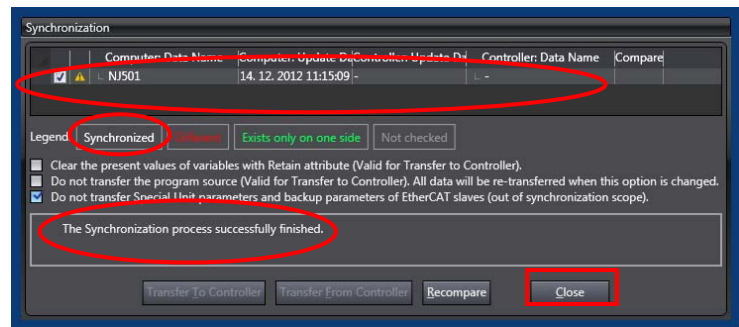

**7.4. Checking the EtherCAT Communications**

Confirm that the EtherCAT communications are performed normally.

**7.4.1. Checking the Connection Status**

Check the connection status of the EtherCAT network.

- 1 Check the LED indicators on the Controller and confirm that the EtherCAT communications are performed normally.

LED indicators in normal status:

- [NET RUN]: Lit green
- [NET ERR]: Not lit
- [LINK/ACT]: Flashing yellow

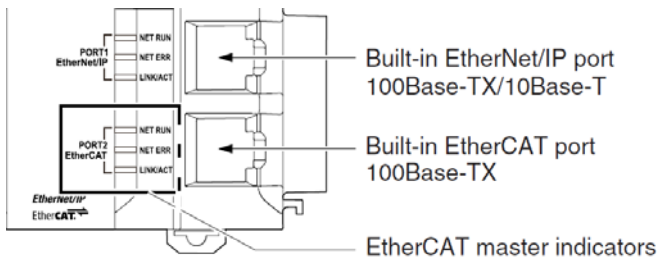

Label	Name	Color	Status	Meaning
EtherCAT NET RUN	RUN	Green	Lit	EtherCAT communications are in progress. • I/O data is being input and output.
			Flashing	EtherCAT communications are established. Communications is in one of the following states. • Only message communications is functioning. • Only message communications and I/O data input operations are functioning.
			Not lit	EtherCAT communications are stopped. • Power is OFF or the Unit is being reset. • There is a MAC address error, communications controller error, or other error.
EtherCAT NET ERR	ERROR	Red	Lit	There is an unrecoverable error, such as a hardware error or an exception.
			Flashing	There is a recoverable error.
			Not lit	There is no error.
EtherCAT LINK/ACT	Link/Activity	Yellow	Lit	The link is established.
			Flashing	A link is established and data is being sent and received. The indicator flashes whenever data is sent or received.
			Not lit	The link is not established.

2 Check the LED indicators on the Digital Sensor Communication Unit.

LED indicators in normal status:

- [PWR]: Lit green
- [L/A IN]: Flickering
- [L/A OUT]: Not lit (last slave)
- [RUN]: Lit green
- [ERR]: Not lit
- [SS]: Lit green

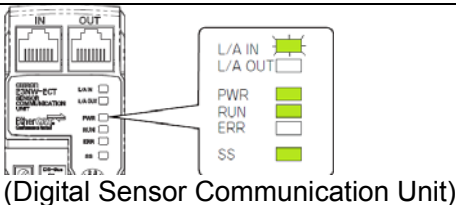

**[PWR] indicator**

Indicates the unit power supply state.

Color	State	Contents
Green	OFF	Unit power OFF state
	ON	The unit power (24 VDC) is supplied to the Slave Unit.

**[L/A IN] indicator**

Indicates the communication state (input side).

Color	State	Contents
Green	OFF	Link not established in physical layer
	Flickering	In operation after establishing link
	ON	Link established in physical layer

**[L/A OUT] indicator**

Indicates the communication state (output side).

Color	State	Contents
Green	OFF	Link not established in physical layer
	Flickering	In operation after establishing link
	ON	Link established in physical layer

**[RUN] indicator**

It indicates the operation state.

Color	State	Contents
Green	OFF	Init state
	Blinking	Pre-Operational state
	Single flash	Safe-Operational state
	ON	Operational state

**[ERR] indicator**

It indicates the information of an error.

Color	State	Contents
Red	OFF	No error
	Blinking	Communications setting error
	Single flash	Synchronization error or communications data error
	Flickering	Boot error
	ON	PDI WDT timeout

**[SS] indicator**

It indicates the information of an Sensor Status.

Color	State	Contents
Green	OFF	Power OFF or Initial status of sensor connection
	ON	Normal
	ON	Sensor Error: Connecting Sensors is different form setting.

The timing of each flashing state of indicator is as follows.

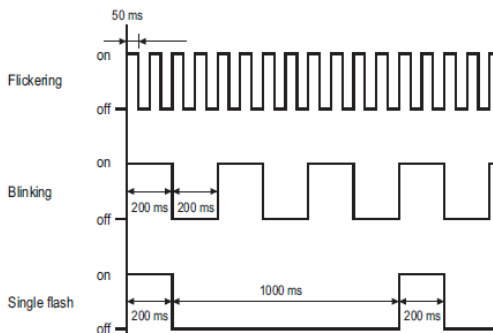

3 Check the LED indicators on the Distributed Sensor Unit.

LED indicators in normal status:  
 [RUN]: Lit green  
 [SS]: Lit green

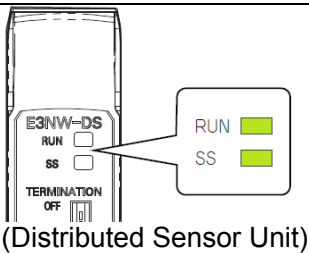

(Distributed Sensor Unit)

● **RUN Indicator**

This indicator gives the operating status.

Color	Status	Meaning
Green	Not lit.	Power OFF, or one of the following errors has occurred: Rotary switch setting error, watchdog timer timeout error, hardware error, RAM check error
	Flashing rapidly	No access for three or more seconds from the Sensor Communication Unit.
	Lit.	Normal status, or Sensor not connected error

● **SS Indicator**

This indicator gives the connection status of the Sensor, or whether there are any other errors.

Color	Status	Meaning
	Not lit.	Initial diagnosis in progress, or one of the following errors occurred after the power was cycled: Hardware error or Sensor not connected error
Green	Lit.	A mismatch error between the number of connected Sensors setting and the number of actually connected Sensors or a RAM check error occurred.
Red	Lit.	Number of connected Sensors comparison error, too many Sensors connected error, RAM check error, or rotary switch setting error

7.4.2. Checking Data that are Sent and Received

Confirm that correct data are sent and received.



## WARNING

Always confirm safety at the destination node before you transfer a user program, configuration data, setup data, device variables, or values in memory used for CJ-series Units from the Sysmac Studio.

The devices or machines may perform unexpected operation regardless of the operating mode of the CPU Unit.

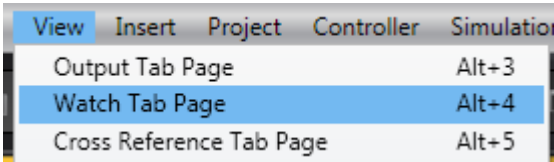
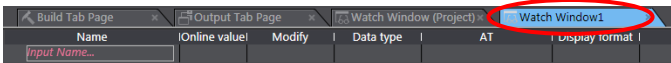
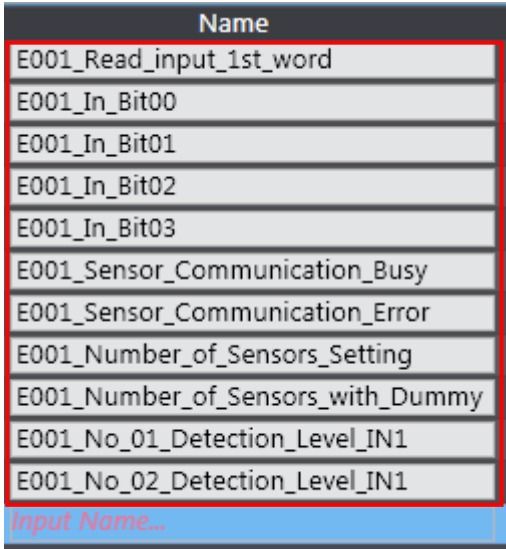

1	Select <b>Watch Tab Page</b> from the View Menu.	
2	The Watch Tab Page 1 is displayed in the lower section of the Edit Pane.	
3	Enter the following names in the Watch Tab Page 1 for monitoring. To enter a new name, click a column stating <i>Input Name...</i>  E001_Read_input_1st_word E001_In_Bit00 E001_In_Bit01 E001_In_Bit02 E001_In_Bit03 E001_Sensor_Communication_Busy E001_Sensor_Communication_Error E001_Number_of_Sensors_Setting E001_Number_of_Sensors_with_Dummy E001_No_01_Detection_Level_IN1 E001_No_02_Detection_Level_IN1	

4

Check the display contents of the Fiber Amplifier.

LED indicators in the figure on the right show as follows:

Outputs of Sensor unit No. 1

- IN2[2]: Lit orange (ON)
- IN1[1]: Lit orange (ON)
- Unit No. 1 Sensor Detection Level Input 1: 1082

\*They are the outputs of the Fiber Amplifier connected to the Digital Sensor Communication Unit.

Outputs of Sensor unit No. 2

- IN2[2]: Lit orange (ON)
- IN1[1]: Lit orange (ON)
- Unit No. 2 Sensor Detection Level Input 2: 1060

\*They are the outputs of the Fiber Amplifier connected to the Distributed Sensor Unit.

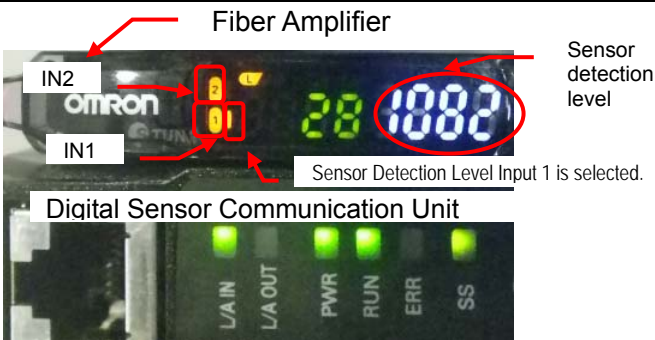

Digital Sensor Communication Unit and Fiber Amplifier (Sensor unit No. 1)

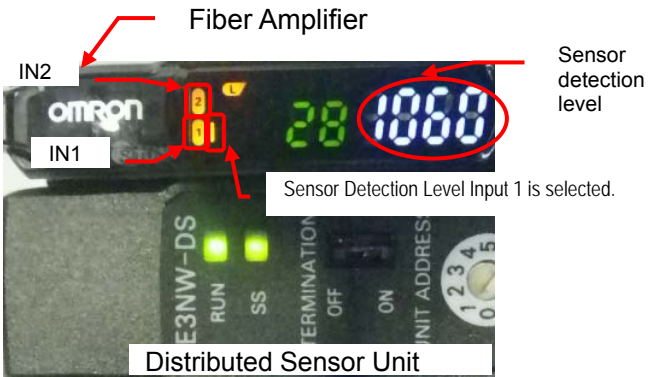

Distributed Sensor Unit and Fiber Amplifier (Sensor unit No. 2)

5 Check the online values.

The values in the figure on the right are as follows:

E001\_Read\_input\_1st\_word:  
IN1 and IN2 of Sensor unit numbers 1 and 2 are TRUE.  
E001\_In\_Bit00: IN1 of Sensor unit number 1 is TRUE.  
E001\_In\_Bit01: IN2 of Sensor unit number 1 is TRUE.  
E001\_In\_Bit02: IN1 of Sensor unit number 2 is TRUE.  
E001\_In\_Bit03: IN2 of Sensor unit number 2 is TRUE.  
E001\_Sensor\_Communication\_Busy:  
The Sensor communication busy is FALSE.  
E001\_Sensor\_Communication\_Error:  
The Sensor communication error is FALSE  
E001\_Number\_of\_Sensors\_Setting :  
The number of Sensors setting is 2  
E001\_Number\_of\_Sensors\_with\_Dummy:  
The number of Sensors is 2  
E001\_No\_01\_Detection\_Level\_IN1  
Unit No. 1 Sensor detection level input 1: 1088  
E001\_No\_02\_Detection\_Level\_IN1  
Unit No. 2 Sensor detection level input 1: 1059

Name	Online value	Modify		Data type
E001_Read_input_1st_word	000F			WORD
E001_In_Bit00	True	TRUE	FALSE	BOOL
E001_In_Bit01	True	TRUE	FALSE	BOOL
E001_In_Bit02	True	TRUE	FALSE	BOOL
E001_In_Bit03	True	TRUE	FALSE	BOOL
E001_Sensor_Communication_Busy	False	TRUE	FALSE	BOOL
E001_Sensor_Communication_Error	False	TRUE	FALSE	BOOL
E001_Number_of_Sensors_Setting	2			USINT
E001_Number_of_Sensors_with_Dummy	2			USINT
E001_No_01_Detection_Level_IN1	1088			INT
E001_No_02_Detection_Level_IN1	1059			INT

## 8. Initialization Method

This document explains the setting procedure from the factory default setting.

Some settings may not be applicable as described in this document unless you use the devices with the factory default setting.

### 8.1. Initializing the Controller

To initialize the settings of the Controller, select **Clear All Memory** from the Controller Menu of the Sysmac Studio. The Clear All Memory Dialog Box is displayed. Check the message on the dialog and if there is no problem, click the **OK** Button.

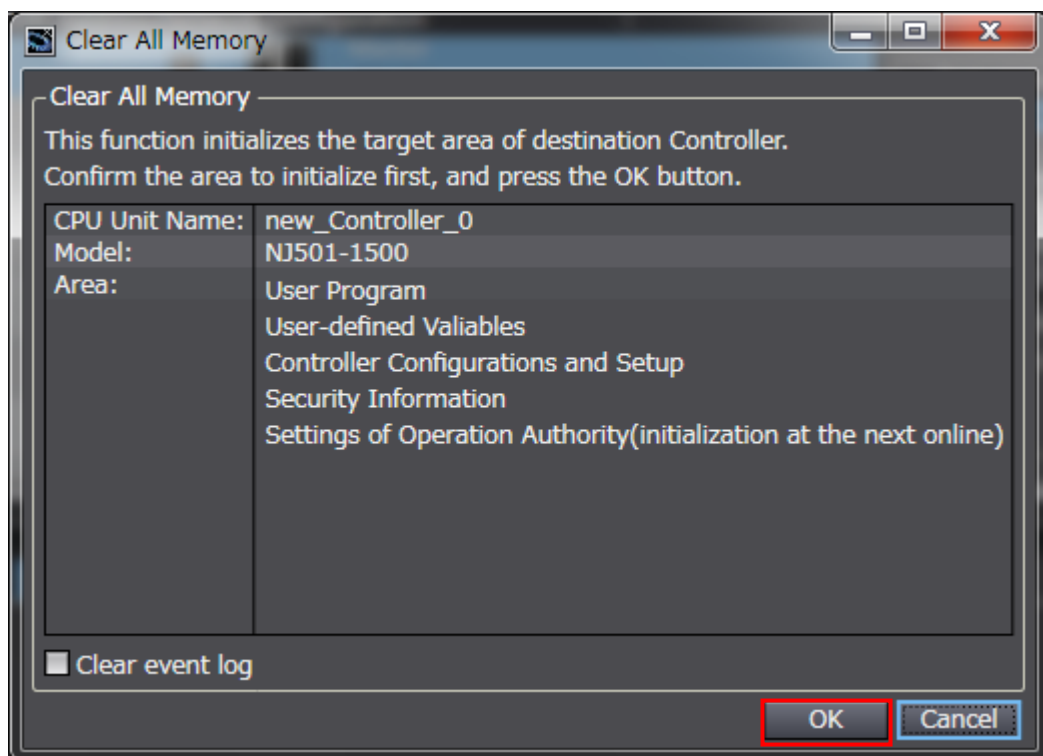



## 9. Revision History

Revision code	Date of revision	Revision reason and revision page
01	2013/06/07	First edition

**OMRON Corporation Industrial Automation Company**

Tokyo, JAPAN

Contact: [www.ia.omron.com](http://www.ia.omron.com)

**Regional Headquarters**

**OMRON EUROPE B.V.**

Wegalaan 67-69-2132 JD Hoofddorp  
The Netherlands

Tel: (31)2356-81-300/Fax: (31)2356-81-388

**OMRON ELECTRONICS LLC**

One Commerce Drive Schaumburg,  
IL 60173-5302 U.S.A.

Tel: (1) 847-843-7900/Fax: (1) 847-843-7787

**OMRON ASIA PACIFIC PTE. LTD.**

No. 438A Alexandra Road # 05-05/08 (Lobby 2),  
Alexandra Technopark,  
Singapore 119967

Tel: (65) 6835-3011/Fax: (65) 6835-2711

**OMRON (CHINA) CO., LTD.**

Room 2211, Bank of China Tower,  
200 Yin Cheng Zhong Road,  
PuDong New Area, Shanghai, 200120, China

Tel: (86) 21-5037-2222/Fax: (86) 21-5037-2200

Authorized Distributor:

© OMRON Corporation 2013 All Rights Reserved.  
In the interest of product improvement,  
specifications are subject to change without notice.

Cat. No. P563-E1-01

0911(-)