

SIEMENS

SIMATIC

Industrial PC SIMATIC IPC277E

Operating Instructions

Preface

Overview

1

Safety instructions

2

Installing and connecting the device

3

Commissioning the device and device functions

4

Operating the device

5

Device expansion and parameter assignment

6

Device maintenance and repairs

7

Technical specifications

8

Technical Support

A

Markings and symbols

B



List of abbreviations

C

Legal information

Warning notice system

This manual contains notices you have to observe in order to ensure your personal safety, as well as to prevent damage to property. The notices referring to your personal safety are highlighted in the manual by a safety alert symbol, notices referring only to property damage have no safety alert symbol. These notices shown below are graded according to the degree of danger.

 DANGER
indicates that death or severe personal injury will result if proper precautions are not taken.
 WARNING
indicates that death or severe personal injury may result if proper precautions are not taken.
 CAUTION
indicates that minor personal injury can result if proper precautions are not taken.
NOTICE
indicates that property damage can result if proper precautions are not taken.

If more than one degree of danger is present, the warning notice representing the highest degree of danger will be used. A notice warning of injury to persons with a safety alert symbol may also include a warning relating to property damage.

Qualified Personnel

The product/system described in this documentation may be operated only by **personnel qualified** for the specific task in accordance with the relevant documentation, in particular its warning notices and safety instructions. Qualified personnel are those who, based on their training and experience, are capable of identifying risks and avoiding potential hazards when working with these products/systems.

Proper use of Siemens products

Note the following:

 WARNING
Siemens products may only be used for the applications described in the catalog and in the relevant technical documentation. If products and components from other manufacturers are used, these must be recommended or approved by Siemens. Proper transport, storage, installation, assembly, commissioning, operation and maintenance are required to ensure that the products operate safely and without any problems. The permissible ambient conditions must be complied with. The information in the relevant documentation must be observed.

Trademarks

All names identified by ® are registered trademarks of Siemens AG. The remaining trademarks in this publication may be trademarks whose use by third parties for their own purposes could violate the rights of the owner.

Disclaimer of Liability

We have reviewed the contents of this publication to ensure consistency with the hardware and software described. Since variance cannot be precluded entirely, we cannot guarantee full consistency. However, the information in this publication is reviewed regularly and any necessary corrections are included in subsequent editions.

Preface

These operating instructions contain all the information you need for commissioning and operating the SIMATIC IPC277E.

It is intended both for programming and testing personnel who commission the device and connect it with other units (automation systems, programming devices), as well as for service and maintenance personnel who install add-ons or carry out fault/error analyses.

Basic knowledge required

A solid background in personal computers and Microsoft operating systems is required to understand this manual. General knowledge in the field automation control engineering is recommended.

Scope of validity of this documentation

These operating instructions are valid for all versions of the SIMATIC IPC277E.

Changes and additions to the manuals are documented in the product information. Therefore, regularly check whether product information has been made available for your product (<https://support.industry.siemens.com/cs/ww/en/ps>).

Scope of this documentation

The documentation for SIMATIC IPC277E consists of:

- Product information, e.g. "Important notes on your device"
- Quick Install Guide SIMATIC IPC277E
- SIMATIC IPC277E operating instructions in English and German

The documentation, in PDF format and in multiple languages, is supplied with the IPC in the documentation package on the USB stick.

Conventions

The terms "PC" or "device" are used in place of the product name SIMATIC IPC277E in these operating instructions.

In these operating instructions, "Windows Embedded Standard" is also used as a standard term for "Windows Embedded Standard 7". "Windows 7" is used as an abbreviation for "Windows 7 Ultimate".

History

The following earlier release versions of these operating instructions have been published:

Edition	Comment
06/2015	First edition
11/2016	Addition of 15" and 19" multitouch devices; Windows 10
04/2017	Addition of 12" multitouch device
09/2017	Operating system information has been replaced by references to separate operating system documents.
11/2019	Conversion to IEC/UL/EN/DIN-EN 61010-2-201

Table of contents

	Preface	3
1	Overview.....	9
1.1	Product description	9
1.2	Configuration of the devices	10
1.2.1	7" and 9" single-touch devices.....	10
1.2.2	12", 15" and 19" single-touch devices	12
1.2.3	7" and 9" devices – interfaces und operator controls	15
1.2.4	12", 15", and 19" single-touch devices – interfaces and operator controls.....	16
1.2.5	12", 15", and 19" multi-touch devices	17
1.2.6	12", 15", and 19" multi-touch devices – interfaces and operator controls	19
1.3	Accessories.....	20
2	Safety instructions	23
2.1	General safety instructions	23
2.2	Notes on usage.....	27
2.3	Use in hazardous areas.....	29
3	Installing and connecting the device	31
3.1	Preparing for installation	31
3.1.1	Checking the delivery package.....	31
3.1.2	Identification data of the device	33
3.1.3	Permitted mounting positions	35
3.1.4	Preparing the mounting cutout.....	37
3.2	Installing the device	39
3.2.1	Installation guidelines	39
3.2.2	Secure with mounting clips	41
3.2.3	Mounting the device with mounting brackets.....	43
3.2.4	Position of the mounting clips for multi-touch devices.....	45
3.2.5	Fastening a device using a VESA adapter	47
3.3	Connecting the device	49
3.3.1	Notes on connecting	49
3.3.2	Connecting the protective earth.....	51
3.3.3	Connecting the power supply to the 7" and 9" devices	53
3.3.4	Connecting the power supply to the 12", 15 and 19" devices	55
3.3.5	Connect device to networks.....	57
3.3.6	Mounting the Ethernet connector strain relief.....	58
3.3.7	Securing cables	58
3.3.7.1	Securing cables for use in hazardous areas	60

4	Commissioning the device and device functions.....	61
4.1	Notes on commissioning and operation.....	61
4.2	Switching the device on/off	62
4.3	Advanced device functions	63
4.3.1	Monitoring functions.....	63
4.3.1.1	Overview of the monitoring functions.....	63
4.3.1.2	Temperature monitoring/display	64
4.3.1.3	Watchdog (WD).....	65
4.3.1.4	Battery monitoring	66
4.3.2	Buffer memory NVRAM	66
5	Operating the device.....	67
5.1	Operator input options	67
5.2	IPC Driver and Tools.....	68
5.3	Operating a device with resistive single-touch screen.....	69
5.4	Operating a device with capacitive multi-touch screen.....	70
6	Device expansion and parameter assignment	73
6.1	Open the device.....	73
6.2	Installing and removing CFast cards.....	75
7	Device maintenance and repairs	77
7.1	Maintenance.....	77
7.2	Repair information.....	77
7.3	Cleaning the Device Front	79
7.4	Installing and removing hardware.....	80
7.4.1	Replacing the backup battery	80
7.4.2	Replacing the drive	82
7.5	Installing the software	83
7.5.1	Reinstalling the operating system.....	83
7.6	Backing up data	83
7.7	Recycling and disposal	83
8	Technical specifications	85
8.1	Certificates and approvals	85
8.1.1	UL HAZ. LOC. and ATEX/IECEX	86
8.1.2	Ex approval	87
8.1.3	UL approval.....	88
8.1.4	Australia, Class A.....	91
8.2	Directives and declarations.....	92
8.2.1	Electromagnetic compatibility for industrial environments.....	92
8.2.2	RoHs directive.....	92
8.2.3	ESD guideline	93

8.3	Dimension drawings.....	96
8.3.1	Dimension drawing of 7" single-touch device.....	96
8.3.2	Dimension drawing of 9" single-touch device.....	97
8.3.3	Dimension drawing of 12" single-touch device.....	98
8.3.4	Dimension drawing of 15" single-touch device.....	99
8.3.5	Dimension drawing of 19" single-touch device.....	100
8.3.6	Dimension drawing of 12" multi-touch device.....	101
8.3.7	Dimension drawing of 15" multi-touch device.....	102
8.3.8	Dimension drawing of 19" multi-touch device.....	103
8.4	Technical specifications.....	104
8.4.1	General technical specifications.....	104
8.4.2	Environmental conditions.....	108
8.4.3	Shipbuilding.....	109
8.4.4	Power supply 7" and 9" device.....	109
8.4.5	Power supply 12", 15" and 19" device.....	111
8.4.6	Delivery state of the pre-installed software.....	112
8.4.6.1	Boot mode.....	112
8.4.6.2	Partitions in Windows Embedded Standard 7.....	112
8.4.6.3	Partitions under Windows 7 x64/x86 and Windows 10.....	113
8.5	Hardware description.....	114
8.5.1	Technical features of the motherboard.....	114
8.5.2	External interfaces.....	114
8.5.2.1	Overview of interfaces.....	114
8.5.2.2	Serial interface.....	115
8.5.2.3	CFast.....	116
8.5.2.4	USB 2.0 port.....	117
8.5.2.5	USB 3.0 port.....	117
8.5.2.6	Ethernet port.....	118
8.5.2.7	DisplayPort.....	119
8.5.3	System resources.....	120
8.5.3.1	Currently allocated system resources.....	120
8.5.3.2	System resources used by the BIOS/DOS.....	120
8.5.4	Input/output address areas.....	122
8.5.4.1	Overview of the internal module registers.....	122
8.5.4.2	Watchdog enable register / 066h select register (read/write, address 062h).....	122
8.5.4.3	Watchdog trigger register (read only, address 066h).....	123
8.5.4.4	Battery status register (read-only, address 50Ch).....	123
8.5.4.5	NVRAM address register.....	124
8.6	BIOS description.....	125
8.6.1	Overview.....	125
8.6.2	Opening the BIOS selection menu.....	126
8.6.3	Structure of the BIOS Setup menu.....	128
8.6.4	Exit menu.....	130
8.6.5	Default BIOS Setup entries.....	131
8.6.6	BIOS update.....	134
8.6.7	Alarm, error and system messages.....	135

A	Technical Support.....	137
	A.1 Service and support.....	137
	A.2 Problem solving.....	138
B	Markings and symbols	139
	B.1 Overview	139
	B.2 Safety	139
	B.3 Operator controls	139
	B.4 Safety-relevant symbols.....	140
	B.5 Certificates, approvals and markings.....	141
	B.6 Interfaces	142
C	List of abbreviations.....	143
	Glossary	147
	Index.....	155

Overview

1.1 Product description



SIMATIC IPC277E provides high-level industrial functionality.

- Compact design
- Rugged
- Maintenance-free operation possible

SIMATIC IPC277E is available with various operating units that differ with regard to the display size. This display is a color display with a backlit "wide-screen" format TFT color display.

Displays are available in the following sizes for the SIMATIC IPC277E:

- 7" Touch single-touch screen
- 9" Touch single-touch screen
- 12" single-touch screen / 12" multi-touch screen
- 15" single-touch screen / 15" multi-touch screen
- 19" single-touch screen / 19" multi-touch screen

1.2 Configuration of the devices

1.2.1 7" and 9" single-touch devices

This section describes the design of the 7" and 9" devices, using the 7" device as an example.

Front and side view 7"

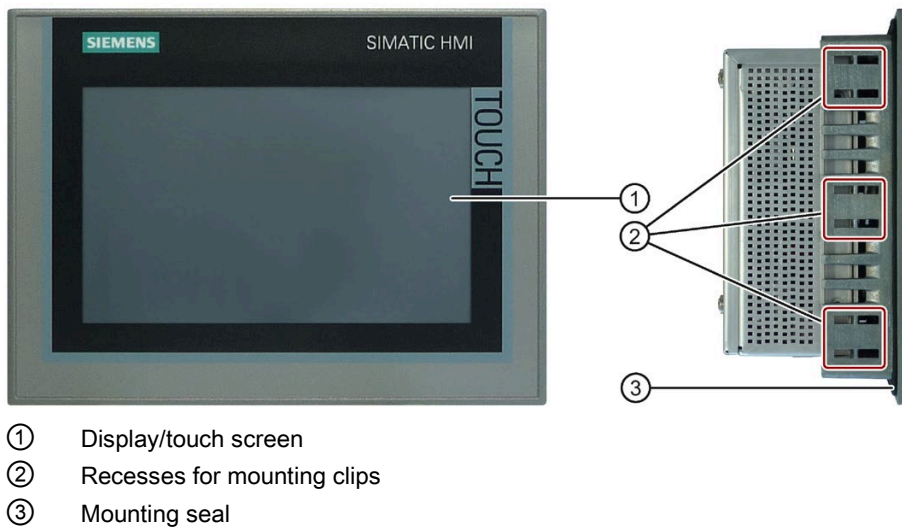

Rear view 7"

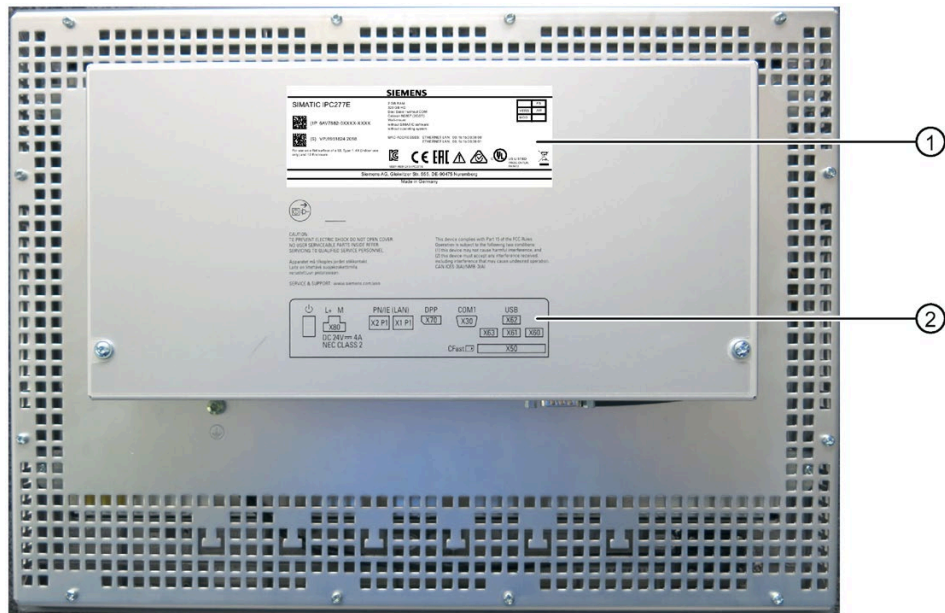

- ① Rating plate
- ② Interface designation

Bottom view 7"

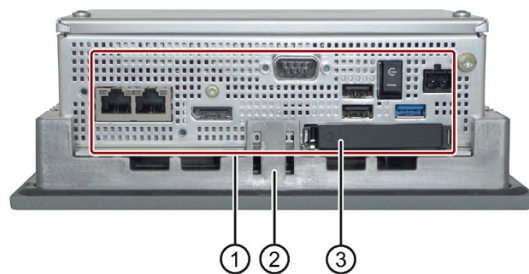

- ① Interfaces and operating elements
- ② Recesses for mounting clips
- ③ Flap for memory card slot

1.2.2 12", 15" and 19" single-touch devices

This section describes the design of the 12", 15", and 19" devices.

Front and side view, 12"

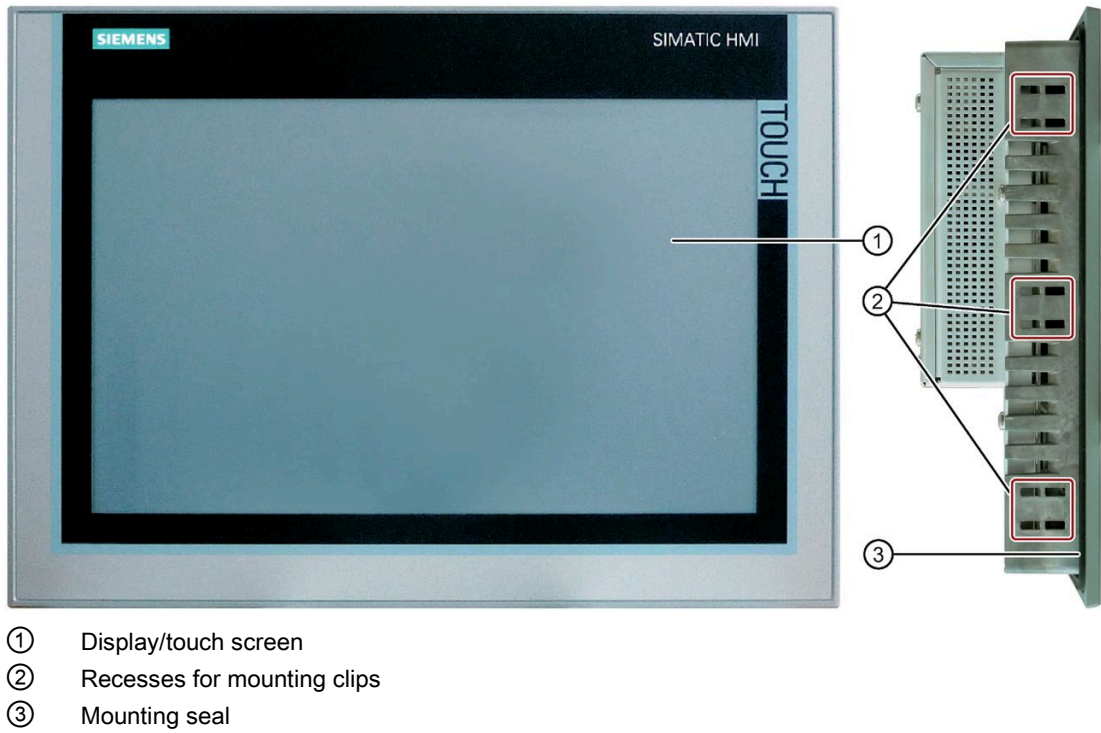

Front view

This section describes the configuration of the 15" and 19" devices using the 15" display as an example.

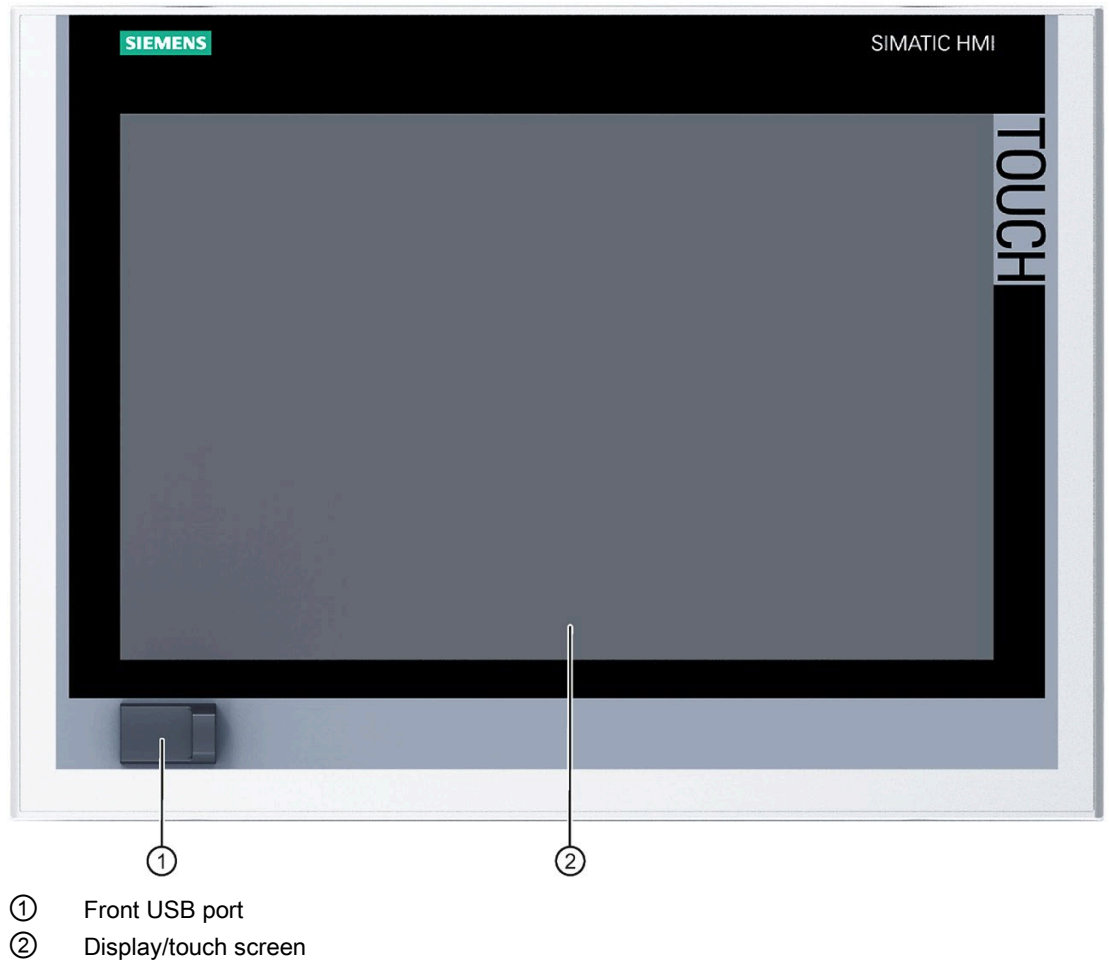

Rear view

This section describes the configuration of the 15" and 19" devices using the 15" display as an example.

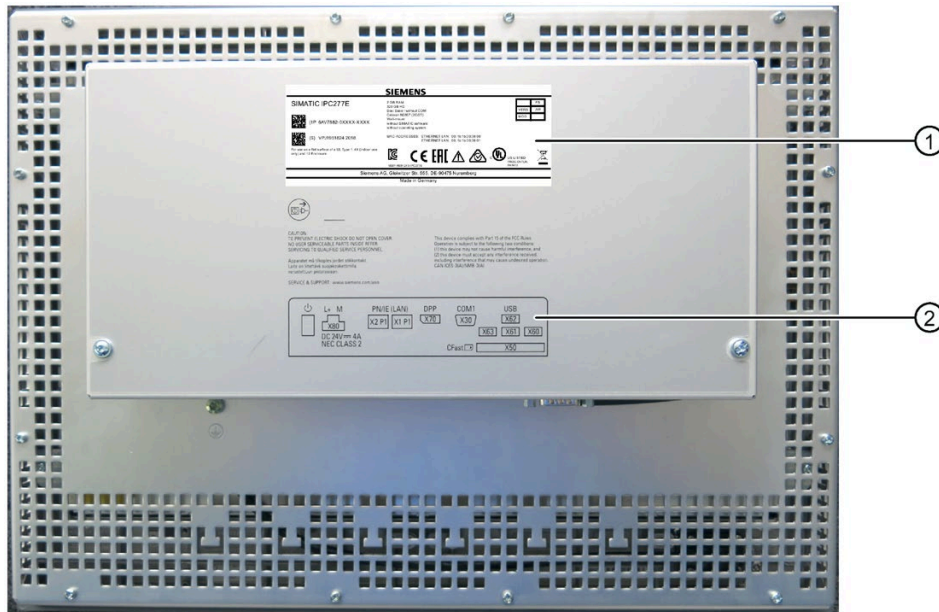

- ① Rating plate
- ② Interface designation

Bottom view

This section describes the configuration of the 15" and 19" devices using the 15" display as an example.

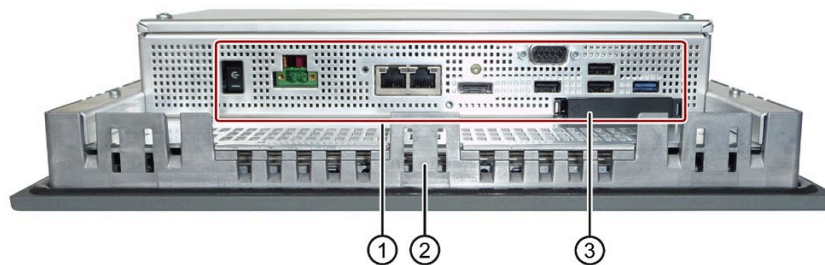

- ① Interfaces and operator controls
- ② Recesses for mounting clips
- ③ Flap for memory card slot

1.2.3 7" and 9" devices – interfaces und operator controls

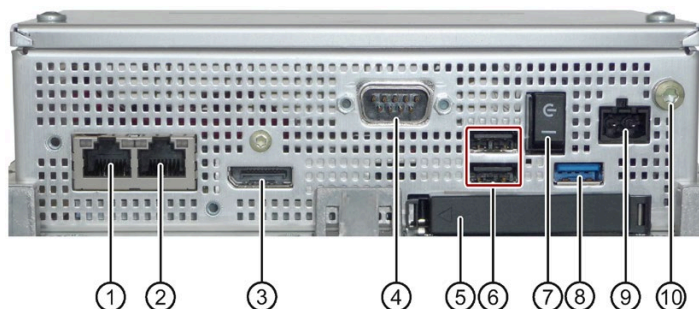

- ① RJ45 Ethernet connection 2 for 10/100/1000 Mbps
- ② RJ45 Ethernet connection 1 for 10/100/1000 Mbps
- ③ DisplayPort connection
- ④ Serial interface 9-pin D-sub connector
 - RS232
 - RS422
 - RS485
- ⑤ Cover for memory card slot
- ⑥ USB 2.0 port, high current
- ⑦ On/off switch. OFF position, when the symbol "C-" is pressed in.
- ⑧ USB 3.0 port, high current
- ⑨ Connection for a 24 VDC power supply
- ⑩ Protective conductor connection

Observe the printing on the rear of the device.

1.2.4 12", 15", and 19" single-touch devices – interfaces and operator controls

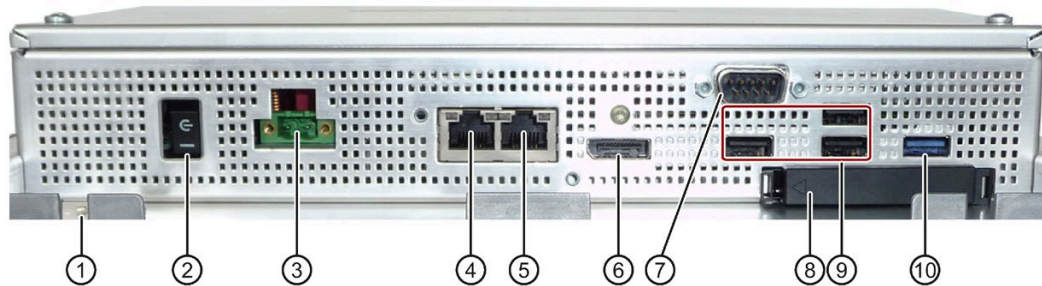

- ① Protective conductor connection
- ② On/off switch: OFF position, when the symbol "C-" is pressed in.
- ③ Connection for a 24 VDC power supply
- ④ RJ45 Ethernet connection 2 for 10/100/1000 Mbps
- ⑤ RJ45 Ethernet connection 1 for 10/100/1000 Mbps
- ⑥ DisplayPort connection
- ⑦ Serial interface, 9-pin D-sub connector
 - RS232
 - RS422
 - RS485
- ⑧ Cover for memory card slot
- ⑨ USB 2.0 port, high current
- ⑩ USB 3.0 port, high current

Observe the printing on the rear of the device.

1.2.5 12", 15", and 19" multi-touch devices

This section describes the design of the 15" and 19" multi-touch devices.

Front, bottom and side view 15" and 19"

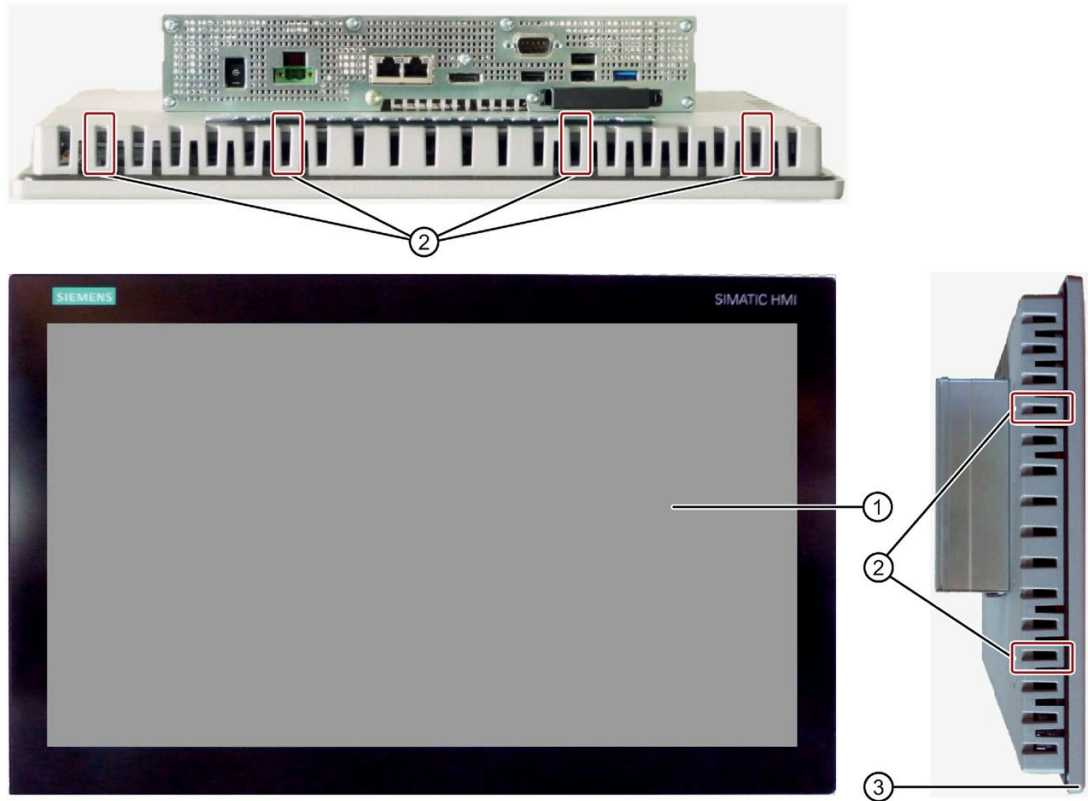

- ① Display/touch screen
- ② Recesses for mounting clips
- ③ Mounting seal

Rear view

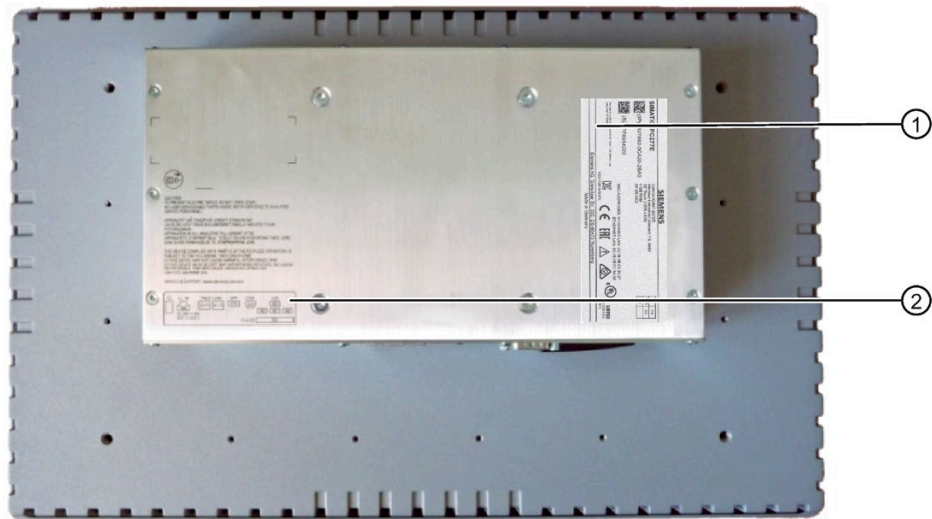

- ① Rating plate
- ② Interface designation

1.2.6 12", 15", and 19" multi-touch devices – interfaces and operator controls

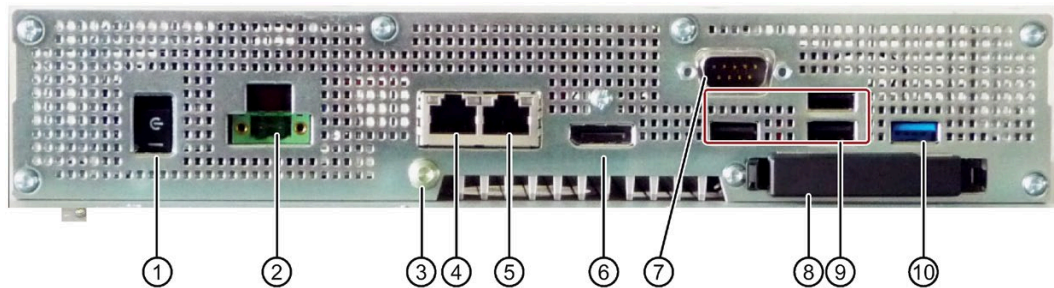

- ① On/off switch: OFF position, when the symbol "C-" is pressed in.
- ② Connection for a 24 V DC power supply
- ③ Protective conductor connection
- ④ RJ45 Ethernet connection 2 for 10/100/1000 Mbps
- ⑤ RJ45 Ethernet connection 1 for 10/100/1000 Mbps
- ⑥ DisplayPort connection
- ⑦ Serial interface, 9-pin D-sub connector
 - RS232
 - RS422
 - RS485
- ⑧ Cover for memory card slot
- ⑨ USB 2.0 port, high current
- ⑩ USB 3.0 port, high current

Observe the printing on the rear of the device.

1.3 Accessories

This chapter contains the scope of accessories valid at the time these operating instructions were written. Additional accessories can be found on the Internet at:

- Expansion components and accessories (http://www.automation.siemens.com/mcms/pc-based-automation/en/industrial-pc/expansion_components_accessories)
- Industry Mall (<https://mall.industry.siemens.com>)

CFast cards

Note

CFast cards can only be replaced with cards of the same manufacturing versions

This device supports only SIMATIC IPC CFast cards with version 02 or higher.

The following CFast cards can be ordered:

- CFast card, 4 GB
- CFast card, 8 GB
- CFast card, 16 GB

Graphics adapter

- DisplayPort DVI adapter
- DisplayPort VGA adapter

Mounting clips

- Mounting clips for multi-touch devices

Other accessories

- Touch stylus, only for devices with resistive single-touch screens

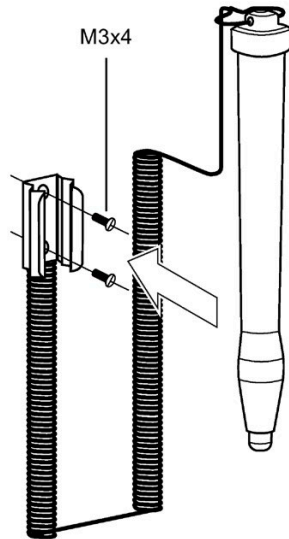

- Touch stylus only for devices with capacitive multi-touch screen



- Mounting bracket (for 15" and 19" single-touch devices)

If there are strict requirements for the front seal, fasten the device in a cabinet with mounting brackets.

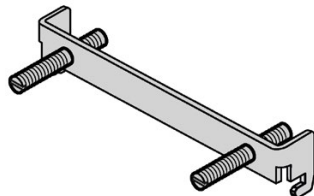

Safety instructions

2.1 General safety instructions

 WARNING
Life-threatening voltages are present with an open control cabinet When you install the device in a control cabinet, some areas or components in the open control cabinet may be carrying life-threatening voltages. If you touch these areas or components, you may be killed by electric shock. Switch off the power supply to the cabinet before opening it.

 WARNING
The installer of the system is responsible for the safety of a system in which the device is integrated. There is a risk of malfunction which could result in death or serious injury. <ul style="list-style-type: none">• Ensure that only suitably qualified personnel perform the work.

System expansions

NOTICE
Damage through system expansions Device and system expansions may be faulty and can affect the entire machine or plant. The installation of expansions can damage the device, machine or plant. Device and system expansions may violate safety rules and regulations regarding radio interference suppression. If you install or exchange system expansions and damage your device, the warranty becomes void.

Note the following for system expansions:

- Only install system expansion devices designed for this device. Contact your technical support team or where you purchased your PC to find out which system expansion devices may safely be installed.
- Observe the information on electromagnetic compatibility (Page 92).

 **WARNING**

Risk of fire through expansion cards

Expansion cards generate additional heat. The device may overheat and cause a fire.

- Observe the safety and installation instructions for the expansion cards.
- Install the device in an enclosure that meets the requirements of paragraph 9.3.2 of the IEC/UL/EN/DIN-EN 61010-2-201 standard.

Battery and rechargeable battery

 **WARNING**

Risk of explosion and release of harmful substances

Improper handling of lithium batteries can result in an explosion of the batteries.

Explosion of the batteries and the released pollutants can cause severe physical injury. Worn batteries jeopardize the function of the device.

Note the following when handling lithium batteries:

- Replace used batteries in good time; see the section "Replacing the backup battery" in the operating instructions.
- Replace the lithium battery only with an identical battery or types recommended by the manufacturer (order no.: A5E34345932).
- Do not throw lithium batteries into fire, do not solder on the cell body, do not recharge, do not open, do not short-circuit, do not reverse polarity, do not heat above 100°C, and protect from direct sunlight, moisture and condensation.

Strong high-frequency radiation

NOTICE

Observe immunity to RF radiation

The device has an increased immunity to RF radiation according to the specifications on electromagnetic compatibility in the technical specifications.

Radiation exposure in excess of the specified immunity limits can impair device functions, result in malfunctions and therefore injuries or damages.

Read the information on immunity to RF radiation in the technical specifications.

ESD Guideline



Electrostatic sensitive devices can be labeled with an appropriate symbol.

NOTICE

Electrostatic sensitive devices (ESD)

When you touch electrostatic sensitive components, you can destroy them through voltages that are far below the human perception threshold.

If you work with components that can be destroyed by electrostatic discharge, observe the ESD Guideline (Page 93).

Industrial Security

Siemens provides products and solutions with industrial security functions that support the secure operation of plants, systems, machines and networks.

In order to protect plants, systems, machines and networks against cyber threats, it is necessary to implement – and continuously maintain – a holistic, state-of-the-art industrial security concept. Siemens' products and solutions constitute one element of such a concept.

Customers are responsible for preventing unauthorized access to their plants, systems, machines and networks. Such systems, machines and components should only be connected to an enterprise network or the internet if and to the extent such a connection is necessary and only when appropriate security measures (e.g. firewalls and/or network segmentation) are in place.

For additional information on industrial security measures that may be implemented, please visit (<http://www.siemens.com/industrialsecurity>).

Siemens' products and solutions undergo continuous development to make them more secure. Siemens strongly recommends that product updates are applied as soon as they are available and that the latest product versions are used. Use of product versions that are no longer supported, and failure to apply latest updates may increase customer's exposure to cyber threats.

To stay informed about product updates, subscribe to the Siemens Industrial Security RSS Feed under (<https://support.industry.siemens.com/cs/ww/en/>).

Disclaimer for third-party software updates

This product includes third-party software. Siemens AG only provides a warranty for updates/patches of the third-party software, if these have been distributed as part of a Siemens software update service contract or officially released by Siemens AG. Otherwise, updates/patches are undertaken at your own risk. You can find more information about our Software Update Service offer on the Internet at Software Update Service (<http://www.automation.siemens.com/mcms/automation-software/en/software-update-service>).

Notes on protecting administrator accounts

A user with administrator privileges has extensive access and manipulation options in the system.

Therefore, ensure there are adequate safeguards for protecting the administrator accounts to prevent unauthorized changes. To do this, use secure passwords and a standard user account for normal operation. Other measures, such as the use of security policies, should be applied as needed.

2.2 Notes on usage

WARNING

Risks associated with the unprotected machine or plant

According to the results of a risk analysis, certain hazard potentials associated with the unprotected machine exist. These hazards could lead to personal injury.

Avoid such hazards by taking the following precautions in accordance with the risk analysis:

- Installation of additional safety equipment on the machine or plant. In particular, the programming, parameter assignment and wiring of the inserted I/O must be executed in accordance with the safety performance identified by the necessary risk analysis (SIL, PL or Cat.).
- Use as intended must be validated for the device by means of a function test on the plant. These tests help you to identify programming, parameter assignment and wiring errors.
- Documentation of the test results that you can enter in the relevant safety verification documents, if necessary.

Environment

NOTICE

Ambient conditions and chemical resistance

Unsuitable environmental conditions have a negative impact on device operation. Chemical substances such as cleaners or fuels may alter the color, shape and structure of the device surface, for example, the front panel.

The device may be damaged, possibly resulting in malfunctions.

For this reason, please observe the following precautions:

- Always operate the device in closed rooms. All warranties shall be void in the case of noncompliance.
- Operate the device only in accordance with the ambient conditions specified in the technical specifications.
- Protect the device against dust, moisture and heat.
- Do not expose the device to direct sunlight or to other strong sources of light.
- Without additional safety measures, such as a supply of clean air, the device may not be used in locations with harsh operating conditions caused by acidic vapors or gases.
- Clean the enclosure surface with a damp cloth and make sure that no water enters the device. See "SIMATIC IPC after-sales information system (<http://www.siemens.com/asis>)".

Note

Use in an industrial environment without additional protective measures

The device has been designed for use in a normal industrial environment in accordance with IEC 60721-3-3 (pollutant class 3C2 for chemical influences, 3S2 for sand and dust).

TFT displays

NOTICE
Burn-in effect and backlighting
The brightness of the backlighting deteriorates over the course of the screen's service life. A permanent picture with bright screen objects leads to a burn-in effect.
<ul style="list-style-type: none">• Use a screen saver to extend the life of the screen and the backlighting and to prevent the burn-in effect.

Defective pixels in the display

At present, the manufacturing process of modern displays does not guarantee that all pixels of the display will be perfect. A small number of defective pixels in the display is therefore unavoidable. This does not present a functional problem as long as the defective pixels are not bunched in one location.

Additional information is available in the section "Technical specifications (Page 104)".

2.3 Use in hazardous areas

The following warnings apply to operating a device with Ex approval in hazardous areas.

! DANGER
DC-Version
If a main circuit breaker for DC-supply should be installed in hazardous locations as described above it has to be intended for use in that area. Otherwise it must be installed in an area which is known to be non-hazardous.

! WARNING
Opening the device
DO NOT OPEN WHEN ENERGIZED.

! WARNING
Risk of explosion when connecting or disconnecting the device
Do not connect or disconnect while circuit is live unless area is known to be non-hazardous.

This equipment is suitable for use in Class I, Division 2, Groups A, B, C, and D or non-hazardous locations only.

! WARNING
Warning - Explosion Hazard - Batteries Must Only Be Changed In An Area Known To Be Non-Hazardous
The lithium battery shall only be replaced by a trained technician.

! WARNING
Replacing components
EXPLOSION HAZARD
WARNING - SUBSTITUTION OF COMPONENTS MAY IMPAIR SUITABILITY FOR CLASS I, DIVISION 2 OR ZONE 2.

Installing and connecting the device

3.1 Preparing for installation

3.1.1 Checking the delivery package

Procedure

1. When accepting a delivery, please check the packaging for visible transport damage.
2. If any transport damage is present at the time of delivery, lodge a complaint at the shipping company in charge. Have the shipper confirm the transport damage immediately.
3. Unpack the device at its installation location.
4. Keep the original packaging in case you have to transport the unit again.

Note

Damage to the device during transport and storage

If a device is transported or stored without packaging, shocks, vibrations, pressure and moisture may impact the unprotected unit. A damaged packaging indicates that ambient conditions have already had a massive impact on the device.

The device may be damaged.

Do not dispose of the original packaging. Pack the device during transportation and storage.

5. Check the contents of the packaging and any accessories you may have ordered for completeness and damage. You will find the accessories, such as mounting hardware and Ethernet connector strain relief, under the foam insert in the box.

3.1 Preparing for installation

6. If the contents of the packaging are incomplete, damaged or do not match your order, inform the responsible delivery service immediately. Fax the enclosed form "SIMATIC IPC/PG Quality Control Report".

! DANGER

Electric shock and fire hazard due to damaged device

A damaged device can be under hazardous voltage and trigger a fire in the machine or plant.

A damaged device has unpredictable properties and states.

Death or serious injury could occur.

- Avoid installing and commissioning a damaged device.
- Label the damaged device and keep it locked away.
- Send off the device for immediate repair.

NOTICE

Damage from condensation

If the device is subjected to low temperatures or extreme fluctuations in temperature during transportation, for example in cold weather, moisture could build up on or inside the HMI device.

Moisture causes a short circuit in electrical circuits and damages the device.

In order to prevent damage to the device, proceed as follows:

- Store the device in a dry place.
- Bring the device to room temperature before starting it up.
- Do not expose the device to direct heat radiation from a heating device.
- If condensation develops, wait approximately 12 hours or until the device is completely dry before switching it on.

7. Please keep the enclosed documentation in a safe place. It belongs to the device. You need the documentation when you commission the device for the first time.
8. Write down the identification data of the device.

3.1.2 Identification data of the device

The device can be clearly identified with the help of this identification data in case of repairs or theft.

Enter the identification data in the following table:









Order number	6AV...
Serial number	S VP
Product version	ES
Windows "Product Key"	
Ethernet address 1 (MAC)	
Ethernet address 2 (MAC)	

You can find this information on the rating plate and COA label. The rating plate is located on the back of the unit. The COA label is only available with pre-installed Windows operating systems and is affixed to the rear of the device.

Procedure

1. Transfer order number, serial number, production version (FS), and Ethernet addresses from the rating plate.

SIEMENS

<p>SIMATIC IPC277E</p>  (1P 6AV7882-0XXXX-XXXX)  (S) VPJ1951824 2018 <small>For use on a flat surface of a UL Type 1, 4X (indoor use only) and 12 Enclosure.</small>	<p>2 GB RAM 320 GB HD Box: Base / without COM Celeron N2807 (2C/2T) Wall-mount without SIMATIC software without operating system</p> <p>MAC-ADDRESSES: ETHERNET LAN: 00: 1b: 1b: 00: 00: 00 ETHERNET LAN: 00: 1b: 1b: 00: 00: 01</p> <p style="text-align: center;">        </p> <p style="text-align: center;"><small>MSIP-REM-249-IPC277E</small></p>	<table border="1" style="width: 100%; border-collapse: collapse;"> <tr> <td style="width: 50%;"></td> <td style="width: 50%; text-align: center;">FS</td> </tr> <tr> <td style="text-align: center;">VERS</td> <td style="text-align: center;">AW</td> </tr> <tr> <td style="text-align: center;">MOD</td> <td style="text-align: center;"></td> </tr> </table>		FS	VERS	AW	MOD	
	FS							
VERS	AW							
MOD								
<p>Siemens AG, Gleiwitzer Str. 555, DE-90475 Nuremberg</p> <p>Made in Germany</p>								

The Ethernet addresses can also be found in the BIOS Setup under "Main > Advanced > Peripheral Configuration" (see section "Technical Specifications").

Note

Replacement device without storage media

When you order a replacement device, remove all the storage media from your device, for example SSD. Insert the storage media in the replacement device.

2. Take down the Windows "Product Key" from the COA label.

Example of a COA label

Microsoft Windows "Product Key" on the "Certificate of Authenticity" (COA):
The COA label is only attached to the rear of the device containing a Windows Embedded Standard 7 or Windows 7 operating system.

- COA label of a device with Windows Embedded Standard 7 operating system



- COA label of a device with Windows 7 operating system



3.1.3 Permitted mounting positions

The device may be mounted in the following positions:

- Standard position: Vertical installation in horizontal format

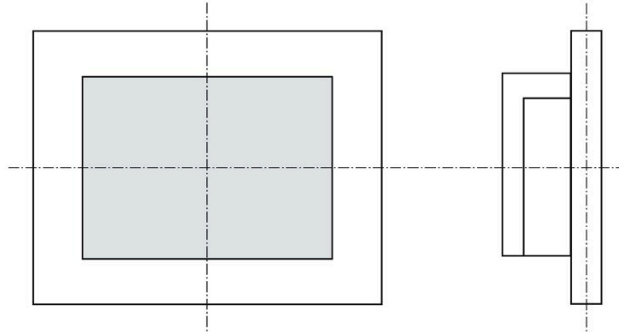

For vertical installation in horizontal format, the following ambient temperatures are permitted:

Maximum ambient temperature at the device			Comment
7", 9" and 12"	15"	19"	
50 °C	50 °C	45 °C	The device enclosure fulfills the requirement of a fire protection enclosure.

- Inclined installation in horizontal format with a vertical inclination of maximum $\pm 45^\circ$

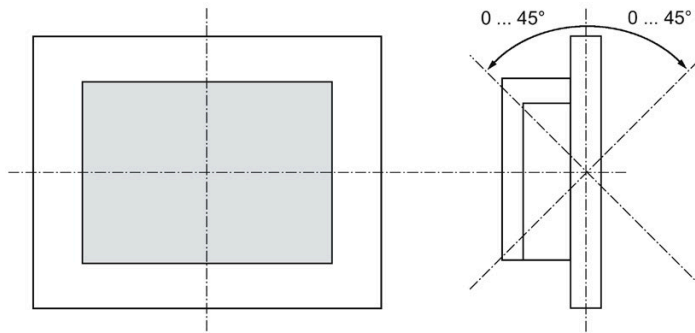

3.1 Preparing for installation

For inclined installation in horizontal format, the following ambient temperatures are permitted:

Maximum ambient temperature at the device			Comment
7", 9" and 12"	15"	19"	
50 °C	45 °C	45 °C	The device enclosure fulfills the requirement of a fire protection enclosure.

- Vertical installation in upright format, display turned through $\pm 90^\circ$ compared with the standard position

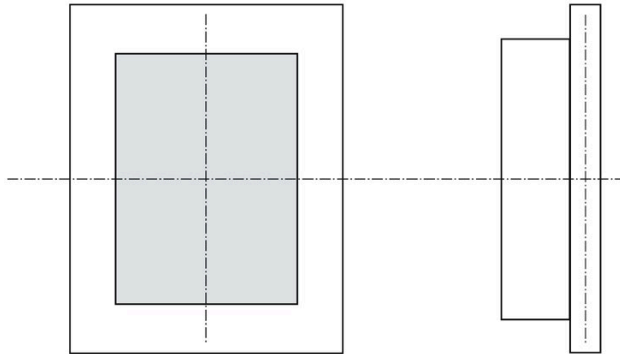

For vertical installation in upright format, the following ambient temperatures are permitted:

Maximum ambient temperature at the device			Comment
7", 9" and 12"	15"	19"	
45 °C	40° C	40° C	The device must be installed in a fire protection enclosure (see "General safety instructions (Page 23)").

3.1.4 Preparing the mounting cutout

Note**Stability of the mounting cutout**

The material in the area of the mounting cutout must provide sufficient strength to guarantee the enduring and safe mounting of the HMI device.

To achieve the degrees of protection described below, it must be ensured that deformation of the material cannot occur due to the force of the mounting clips or operation of the device.

Degrees of protection

The degrees of protection of the HMI device can only be guaranteed if the following requirements are met:

- Material thickness at the mounting cutout for IP65 degree of protection, or for enclosure type 4X/type 12 (indoor use only): 2 mm to 6 mm
- Permissible deviation from plane at the mounting cutout: ≤ 0.5 mm
This condition must be fulfilled for the mounted HMI device.
- Permissible surface roughness in the area of the seal: ≤ 120 μm (R_z 120)

Dimensions of the mounting cutout

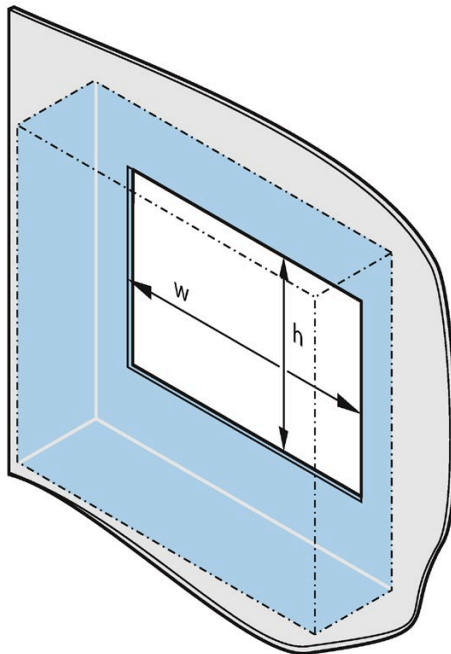

3.1 Preparing for installation

The following table shows the dimensions of the required mounting cutout:

Mounting cutout	Device							
	7" ²	9" ²	12" ²	12" ³	15" ²	15" ³	19" ²	19" ³
Width w ¹ in mm	197 ⁺¹	251 ⁺¹	310 ⁺¹	299 ⁺¹	395 ⁺¹	382	464 ⁺¹	448 ⁺¹
Height h ¹ in mm	141 ⁺¹	166 ⁺¹	221 ⁺¹	211 ⁺¹	290 ⁺¹	241	318 ⁺¹	278 ⁺¹

- 1 Width and height must be interchanged for mounting in vertical format.
- 2 Device with resistive single-touch screen
- 3 Device with capacitive multi-touch screen

3.2 Installing the device

3.2.1 Installation guidelines

The installer of the plant is responsible for proper installation of the device.

WARNING

Dangerous voltage in control cabinet

A high voltage may be present in the switchgear cabinet and could cause a dangerous electric shock.

It may result in death or serious physical injury.

Isolate the power supply to the control cabinet before opening it. Ensure that the power to the control cabinet cannot be turned on accidentally.

NOTICE

Risk of fire

If you install the device in an unapproved mounting position or if you do not observe the ambient conditions, the device can overheat.

Overheating can cause a fire. Proper functioning of the device is no longer guaranteed.

Before you install the device, note the following general installation information.

Note

In the standard installation position, the device meets the requirements for fire protection enclosures in accordance with EN 61010-2-201. It can therefore be installed without an additional fire protection covering.

- Install the device only in one of the permitted mounting positions.
- For installation in control cabinets, note the SIMATIC setup guidelines as well as the relevant DIN/VDE requirements or the country-specific regulations.
- Provide adequate volume in the control cabinet for air circulation and heat transport. Keep at least 5 cm distance between the device and control cabinet.
- The ventilation slots of the device may not be covered or obstructed.
- The minimum distance between the device and the cabinet is 5 cm at the air output end.
- Ensure there is enough free space in the control cabinet to allow the cover to be removed.
- Equip the control cabinet with struts for stabilizing the mounting cut-out. Install struts where necessary.

IP65 degree of protection

 **WARNING**

Risk of electric shock

The specified degree of protection cannot be guaranteed if the device is not correctly installed. Moisture or water could leak in and cause electric shock or destroy the plant.

The degree of protection IP65 is ensured for the front of the device under the following conditions:

- The mounting cutout was prepared based on the correct dimensions; see chapter "Preparing the mounting cutout (Page 37)".
- The device was secured with the supplied mounting clamps or with clamps which can be optionally ordered.
- The mounting seal is undamaged.

See also

Technical specifications (Page 104)

Dimension drawings (Page 96)

3.2.2 Secure with mounting clips

Positions of the mounting clips

To achieve the degree of protection for the HMI device, the positions for the mounting clips shown below must be adhered to.

The positions of the mounting clips are marked by stamps on the cutouts. Fit the mounting clips in all the stamped cutouts.

The following table shows the type, number, and position of the mounting clips needed for the respective HMI devices.

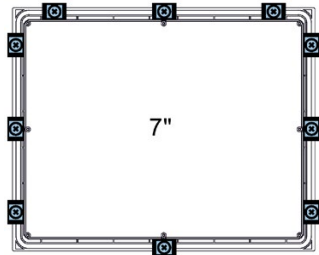
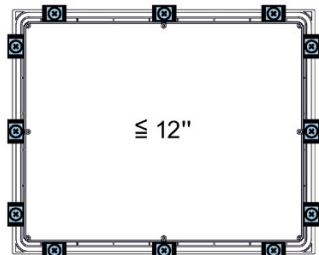
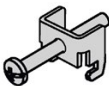
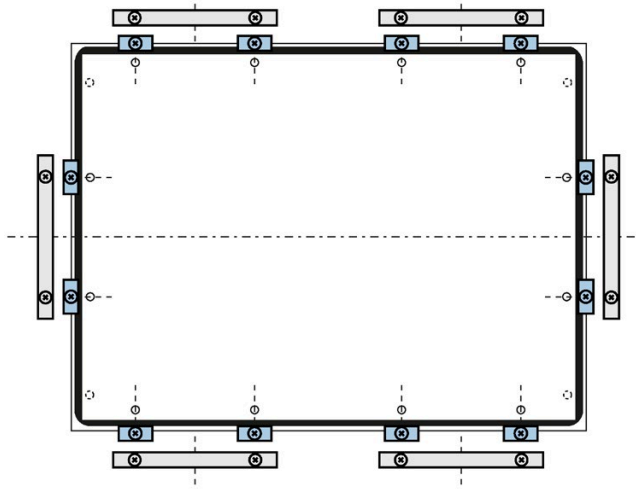
HMI device	Mounting clips		
	Type	Quantity	Position on the HMI device
7" display		10	
9" display 12" display		12	
15" display 19" display		12	

Requirement

- All packaging components and protective foils should be removed from the HMI device.
- To install the HMI device, you need the mounting clips from the accessories kit.

Procedure

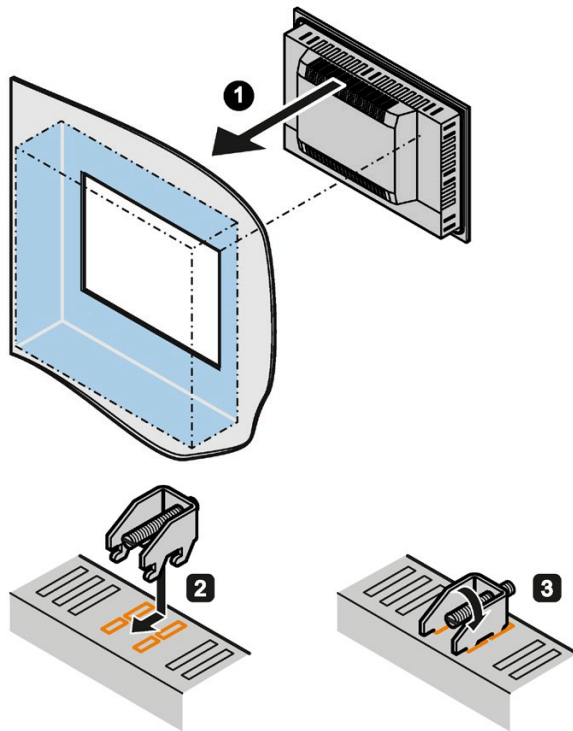

- 1** Insert the HMI device into the mounting cutout from the front.
- 2** Insert a mounting clip into the cutout provided on the HMI device.
- 3** Tighten the threaded pin to secure the mounting clip. The threaded pins have a maximum tightening torque of 0.5 Nm on the 7, 9, and 12 inch variants.
- 4** Repeat steps 2 and 3 for all mounting clips.
- 5** Check the fit of the mounting seal.

Result

The HMI device is mounted and the relevant degree of protection is ensured at the front.

3.2.3 Mounting the device with mounting brackets

If there are strict requirements for the front seal, it may be necessary to fasten the device with mounting brackets in a cabinet. You can secure each device with 6 mounting brackets.

The mounting brackets are available as accessories. You can find ordering information in the section Accessories (Page 20).

Requirement

- All packaging components and protective films have been removed from the device.
- The accessory mounting brackets are available.
- 2.5 mm hexagonal spanner

Procedure

Note

If the mounting seal is damaged or protrudes over the device, the degree of protection is not guaranteed.

1. Working from the front, insert the device into the mounting cut-out.

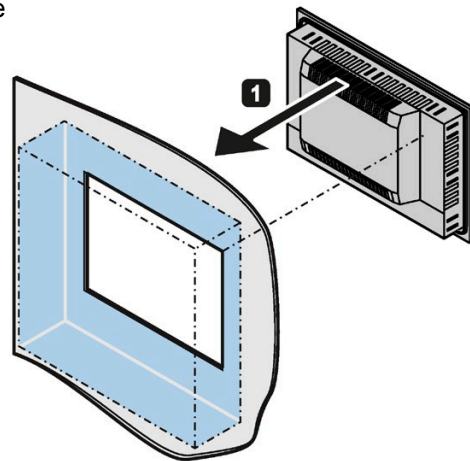

3.2 Installing the device

2. Insert the mounting clamp into the recesses on the device. Make sure it is in the correct position, see the section "Secure with mounting clips (Page 41)".

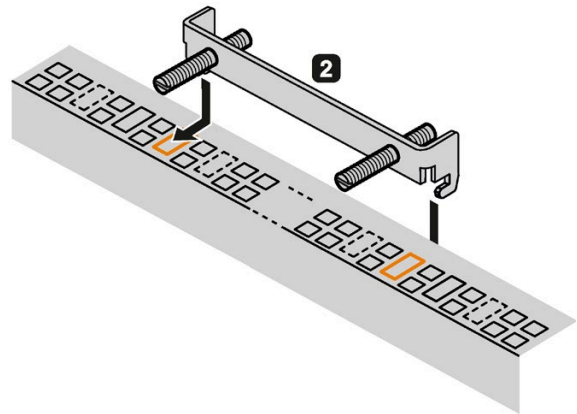

3. Secure the mounting bracket by tightening the threaded pins. The maximum permissible torque is 0.5 Nm.

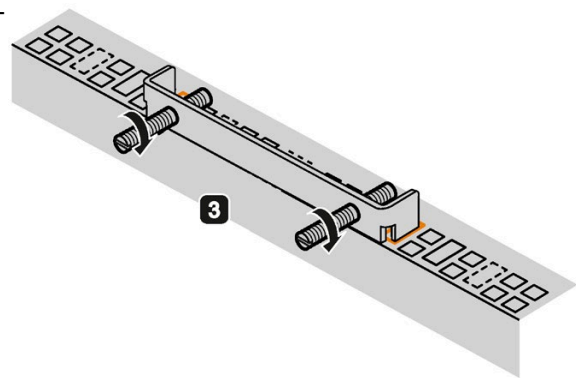

4. Repeat steps 2 and 3 until all mounting brackets are attached.
5. Check the fit of the mounting seal.

IP65 degree of protection

The installer of the plant is responsible for proper installation of the device.

! WARNING

Risk of electric shock

The degree of protection cannot be guaranteed if the device is not correctly installed. Moisture or water can penetrate and cause electric shock or plant damage.

The IP65 degree of protection is ensured for the front of the device only if you observe the following:

- Installation with mounting clamps
- The circumferential seal is properly attached to a correctly sized cutout.
- Follow the instructions when measuring the dimensions as shown in the section "Preparing the mounting cutout (Page 37)".

3.2.4 Position of the mounting clips for multi-touch devices

Fasten the mounting clips (available as accessory) to the positions as illustrated.



Device	Position
19" display	
15" display	

3.2 Installing the device

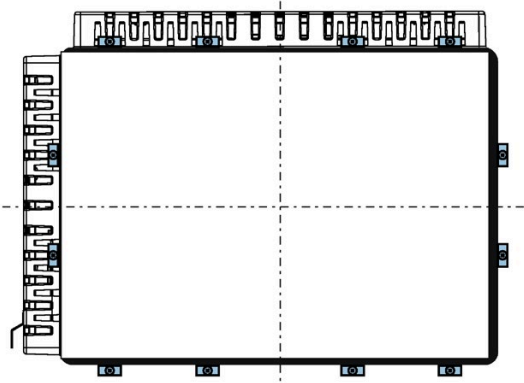
Device	Position
12" display	

3.2.5 Fastening a device using a VESA adapter

You can also fasten the SIMATIC IPC277E using a VESA adapter.

Different models of VESA adapters are offered by third-party manufacturers.

Note

When fastening the VESA adapter, shock or vibration is not permitted.

NOTICE

Degree of protection for overall device
--

If you secure the device using a VESA adapter, IP65 degree of protection and UL50 enclosure type 4X / 12 (indoor use only) of the entire device will be lost. Spray and water jets as well as penetrating substances can then damage the device.
--

NOTICE

Dimensioning of the VESA adapter

When selecting the VESA adapter, make sure that it is designed for at least four times the weight of the device.
--

 WARNING

The device must be mounted securely
--

Inadequately dimensioned fastening material may cause the device to fall down. Serious bodily injury may result.
--

Make sure that fasteners are adequately dimensioned during installation of the device. Make sure to consider the weight of the device and the forces acting on the device when dimensioning the fasteners. This applies in particular to dynamic load of the device. All fasteners including mounting surfaces, support arm systems, and fastening elements such as screws must be able to carry at least four times the weight of the device.
--

Observe any further statutory specifications applying at the location of use of the device and further applicable regulations with regard to the fastening of the device.

Procedure

Fasten the VESA adapter with the designated screws (M4).

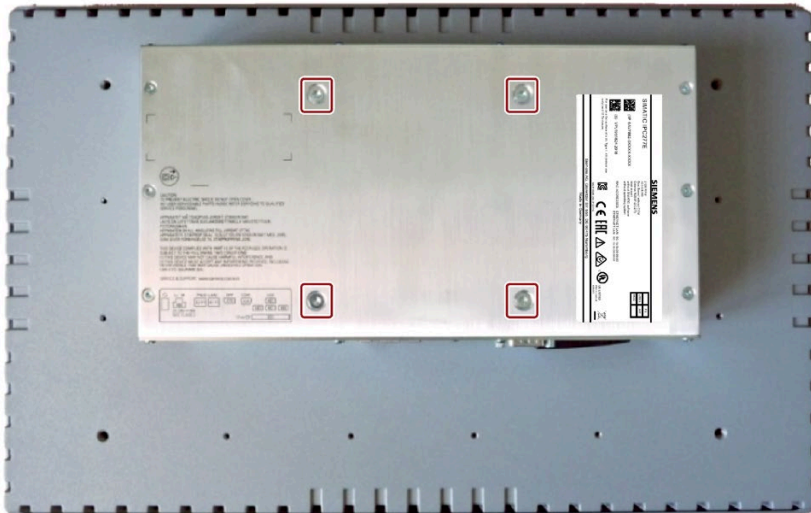

Additional information

Dimension drawing of 12" multi-touch device (Page 101)

Dimension drawing of 15" multi-touch device (Page 102)

Dimension drawing of 19" multi-touch device (Page 103)

3.3 Connecting the device

3.3.1 Notes on connecting

 WARNING
Risk of fire and electric shock
The on/off switch does not isolate the device from the power supply. Risk of electric shock if the device is opened incorrectly or defective. There is also a risk of fire if the device or connecting lines are damaged. Death or serious bodily injury can result.
You should therefore protect the device as follows:
<ul style="list-style-type: none">• Always pull out the power plug when you are not using the device or if the device is defective. The power plug must be freely accessible.• Connect the device to a protective conductor as instructed (see "Connecting the protective conductor").• Use a central power isolating switch for cabinet installation.

 WARNING
Risk of lightning strikes
A lightning flash may enter the mains cables and data transmission cables and jump to a person.
Death, serious injury and burns can be caused by lightning.
Take the following precautions:
<ul style="list-style-type: none">• Disconnect the device from the power supply in good time when a thunderstorm is approaching.• Do not touch mains cables and data transmission cables during a thunderstorm.• Keep a sufficient distance from electric cables, distributors, systems, etc.

NOTICE
Fault caused by I/O devices
The connection of I/O devices can cause faults in the device.
The result may be personal injury and damage to the machine or plant.
Note the following when connecting I/O devices:
<ul style="list-style-type: none">• Read the documentation of the I/O devices. Follow all instructions in the documentation.• Only connect I/O devices which are approved for industrial applications in accordance with EN 61000-6-2 and IEC 61000-6-2.• I/O devices that are not hotplug-capable may only be connected after the device has been disconnected from the power supply.

NOTICE

Damage through regenerative feedback

Regenerative feedback of voltage to ground by a connected or installed component can damage the device.

Connected or built-in I/Os, for example, a USB drive, are not permitted to supply any voltage to the device. Regenerative feedback is generally not permitted.

3.3.2 Connecting the protective earth

A connected protective conductor discharges dangerous electrical charges from the metal enclosure. The current flowing through the protective conductor when such a fault occurs triggers an upstream protective device that disconnects the machine from the power supply.

The protective conductor also improves the discharge of interference generated by external power cables, signal cables or cables for I/O modules to ground.

The connection for the protective earth is labeled with the following symbol:



WARNING

Electric shock and risk of fire

High voltage may be present in a defective device, which can cause fire or an electric shock if touched. Death and serious bodily injury can result.

- Connect the device to the protective conductor before you put it into operation.
- The PE terminal on the device must be connected to the protective conductor of the control cabinet or system in which the device is installed.
- Never operate the device without protective conductor.
- If a device is defective, remove it from operation without delay and label it accordingly.

Requirement

- T20 screwdriver
- Cable lug for M4
- PE conductor with a minimum cross-section of $2.5 \text{ mm}^2 = \text{AWG14}$

Procedure

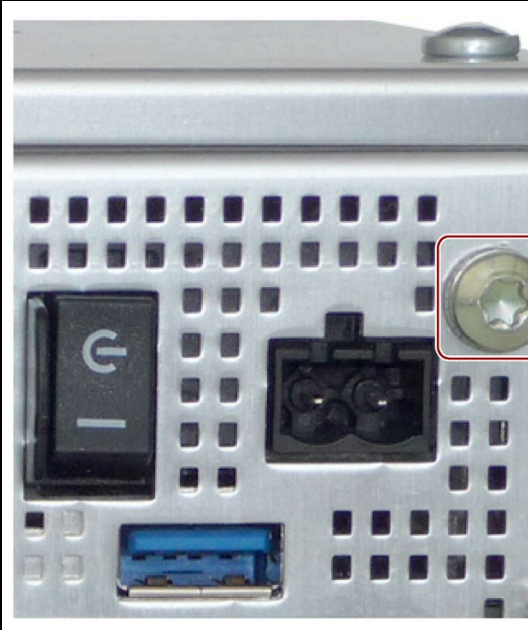
	1	Clamp the cable lug onto the protective earth.
	2	Firmly attach the cable lug to the protective conductor connection on the device using the M4 thread (see part labeled).
	3	Connect the protective conductor to the protective conductor connection of the cabinet or the plant in which the device is installed.

3.3.3 Connecting the power supply to the 7" and 9" devices

Note

The device may only be connected to a 24 V DC power supply which meets the requirements of a safe extra-low voltage (SELV/PELV) in accordance with IEC/EN/DIN EN/UL 60950-1 or IEC/EN/DIN EN/UL 61010-2-201.

The power supply must fulfill the requirements of NEC Class 2 or LPS of IEC/EN/DIN EN/UL 60950-1 or Limited Energy according to IEC/EN/DIN EN/UL 61010-2-201.

Note

The 24 V DC power supply must be adapted to the input data of the device (see the section "Technical specifications").

Requirement

- The protective conductor is connected.
- You are using the connection terminal supplied.
- A two-core cable with a cable cross-section for the 24 V DC connection of at least 0.75 mm² (= AWG18) up to maximum 2.5 mm² (= AWG14).
- A slotted screwdriver with approx. 3 mm blade.

Procedure

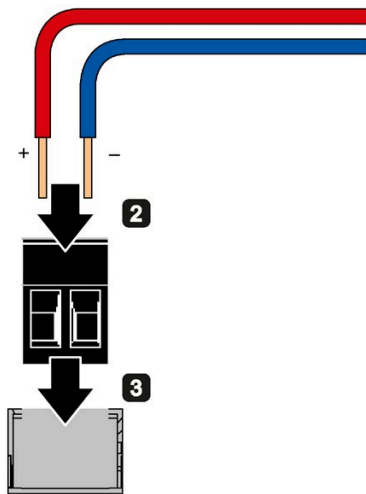

- 1** Switch off the 24 V DC power supply.
- 2** Connect the wires of the power supply.

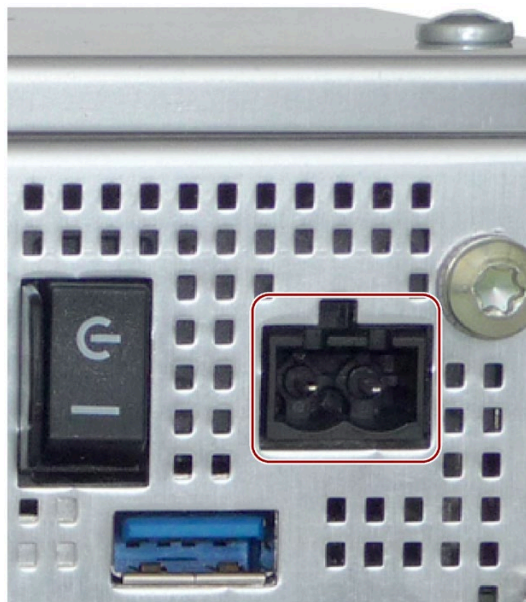

- 3** Connect the connection terminal at the marked position.

3.3.4 Connecting the power supply to the 12", 15 and 19" devices

Note

The device may only be connected to a 24 V DC power supply which meets the requirements of a safe extra-low voltage (SELV/PELV) in accordance with IEC/EN/DIN EN/UL 60950-1 or IEC/EN/DIN EN/UL 61010-2-201.

The power supply must fulfill the requirements of NEC Class 2 or LPS of IEC/EN/DIN EN/UL 60950-1 or Limited Energy according to IEC/EN/DIN EN/UL 61010-2-201.

Note

The 24 V DC power supply must be adapted to the input data of the device (see the section "Technical specifications").

Requirement

- The protective conductor is connected.
- You are using the connection terminal supplied.
- A two-core cable with a cable cross-section for the 24 V DC connection of at least 0.75 mm² (= AWG18) up to maximum 2.5 mm² (= AWG14).
- A slotted screwdriver with approx. 3 mm blade.

Procedure

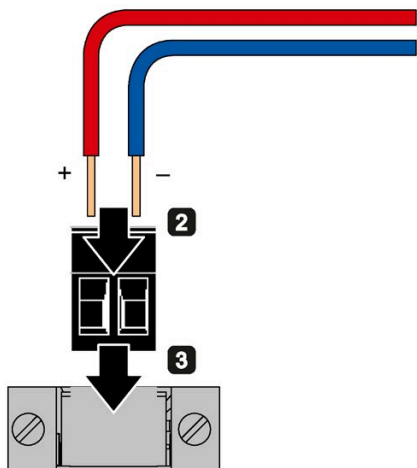

- 1 Switch off the 24 V DC power supply.
- 2 Connect the wires of the power supply.

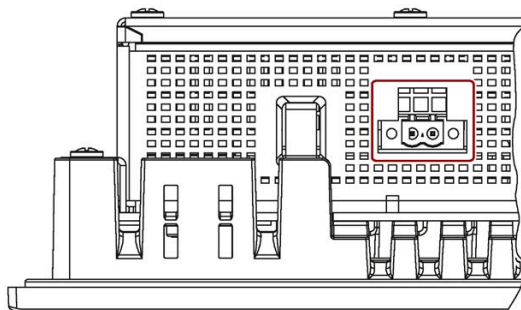

- 3 Connect the connection terminal at the marked position.

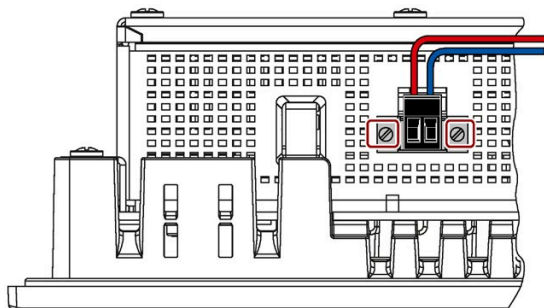

- 4 Secure the connection terminal with the marked screws.

3.3.5 Connect device to networks

The following options are available for integrating the device in existing or planned system environments and networks.

Ethernet

You can use the integrated Ethernet interfaces (10/100/1000 Mbps) for communication and data exchange with automation devices, e.g. SIMATIC S7.

You need suitable software to use this functionality: STEP 7, WinCC, WinAC, SIMATIC NET.

Industrial Ethernet

You can establish a network between the device and other computers via Industrial Ethernet. The on-board LAN interfaces are twisted-pair TP interfaces with a data transmission rate of 10/100/1000 Mbps.

Note

You need a category 6 Ethernet cable for operation at 1000 Mbps.

PROFINET

PROFINET can be operated via:

- Standard Ethernet interfaces (RT)

SIMATIC NET

You can use this software package to create, operate and configure an innovative network for Field & Control level. Information on this can be found on the SIMATIC NET Manual Collection CD. The software package and the documentation are not included in the scope of delivery.

Additional information

You can find additional information on the Internet at: Technical Support (<https://support.industry.siemens.com>)

3.3.6 Mounting the Ethernet connector strain relief

The Ethernet connector strain relief safely prevents the unintentional disconnection of the Ethernet connectors from the device. The Ethernet connector strain relief is included with the device.

Procedure

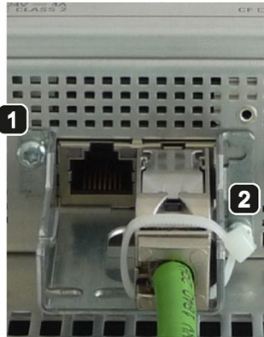

- 1** Screw the Ethernet connector strain relief to the bottom of the enclosure.
- 2** Secure the Ethernet connectors using cable ties.

3.3.7 Securing cables

On the rear panel of the devices, you will find fastening eyelets for cable ties for strain relief of the following connecting cables:

- Power supply cable
- RS232 cable
- USB cables

Procedure for single-touch device

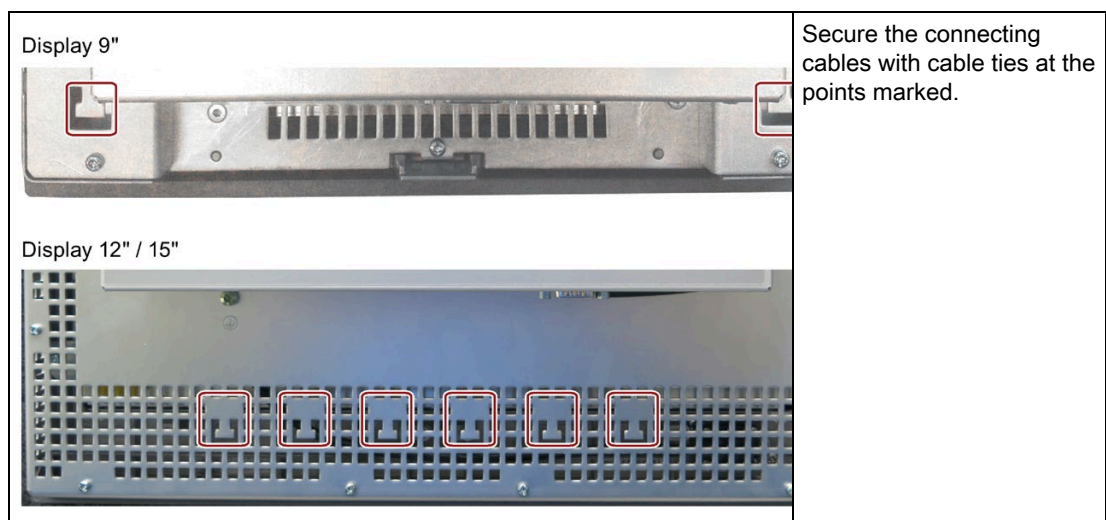

Procedure for multi-touch device

You can install a strain relief (included in scope of delivery) on the rear panel using the 4 marked screws.

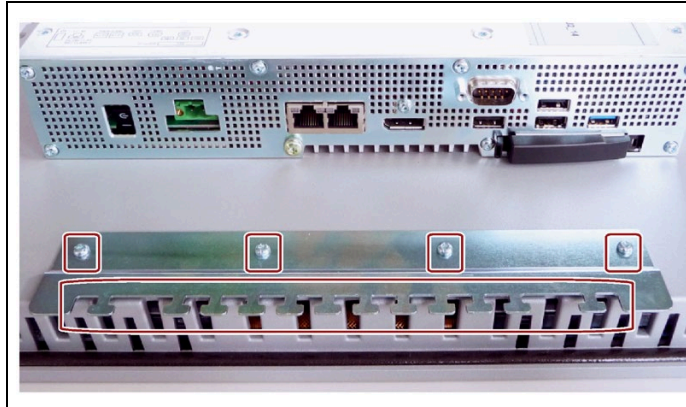

Secure the connecting cables with cable ties at a suitable point in the marked area.

3.3.7.1 Securing cables for use in hazardous areas

Strain relief

Use cable ties to secure the connected cables (USB, DisplayPort and LAN) to the selected fixing elements for strain relief.

Make sure that the cables are not crushed by the cable ties.

Secure the cable mounting plate to the device using the supplied screws.

The following figure shows an example of the fixing elements of a built-in device.

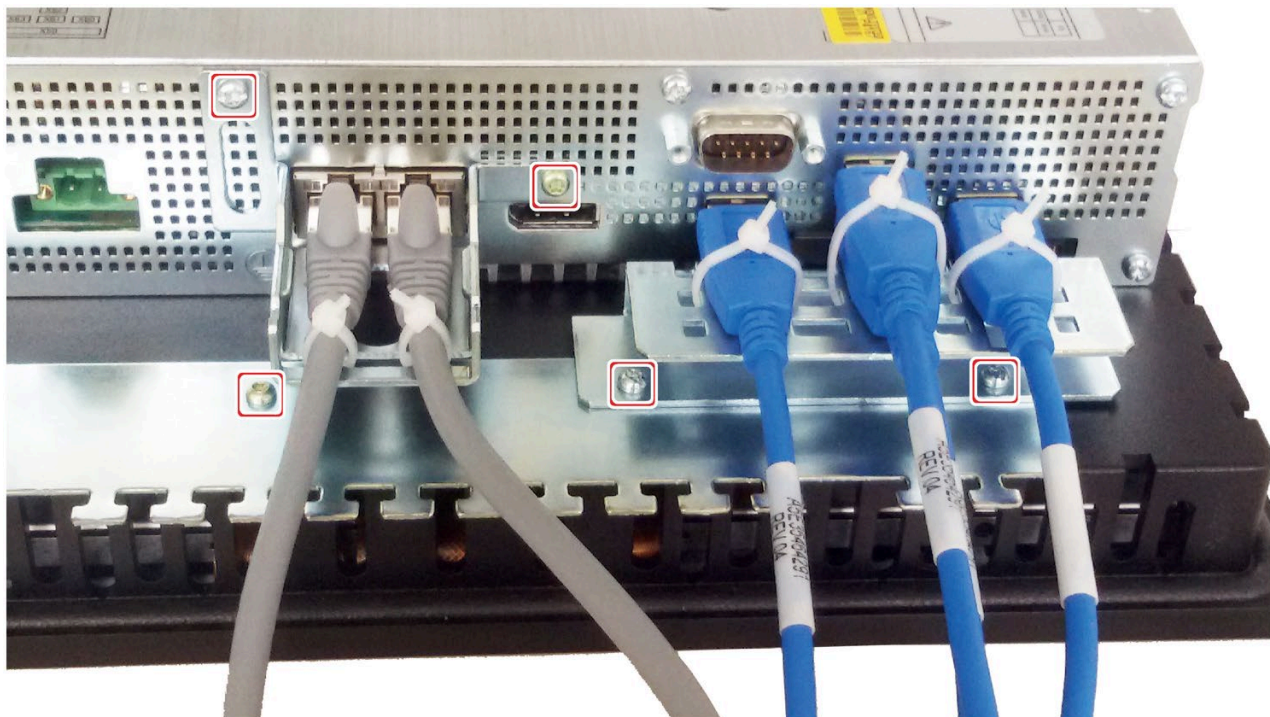

Commissioning the device and device functions

4.1 Notes on commissioning and operation

 CAUTION
Danger of burns The surface of the device can reach temperatures of 65 °C. Any unprotected contact may cause burns. Avoid direct contact during operation of the device. Touch the device only with appropriate protective gloves.

Note**Configuring memory cards in the device**

Memory cards used in a device need to be configured on that device. Memory cards configured on other devices will not boot as the drive parameters will be different.

Notes on operation

Note**During the boot process...**

- Make sure that there are no conductive liquids on the touch screen during startup.
 - Do **not** touch the touch screen during startup.
The device automatically calibrates the touch screen during startup.
-

Requirement

- The device is connected to the power supply.
- The protective conductor is connected.
- The connection cables are plugged in correctly.
- The following hardware is available for initial commissioning:
 - One USB keyboard
 - One USB mouse

4.2 Switching the device on/off

Following the initial switch-on, the operating system pre-installed on the device is set up automatically on the device.

NOTICE

Faulty installation

Do not switch off the device during the entire installation process. Do not change the default values in the BIOS setup.

Procedure - Switching on the device

1. Set the On/Off switch to "ON" position.

The module carries out a self-test. During the self-test, the following message appears:

```
Press ESC for boot options
```

2. Wait for the message to disappear.
3. Follow the instructions on the screen.

Procedure - Switching off the device

To turn off the device, always select "Start > Shutdown".

If the device is not going to be used for a long period of time after shutdown, set the on/off switch to the  position.

Additional information

Information on your operating system is available on the Internet and on the supplied USB stick:

- Microsoft® Windows® 7
(<https://support.industry.siemens.com/cs/ww/de/view/109749497/en?dl=en>)
- Microsoft® Windows® 10
(<https://support.industry.siemens.com/cs/ww/de/view/109749498/en?dl=en>)
- Microsoft® Windows Embedded Standard® 7
(<https://support.industry.siemens.com/cs/ww/de/view/109749499/en?dl=en>)

See also

Installing the software (Page 83)

4.3 Advanced device functions

4.3.1 Monitoring functions

4.3.1.1 Overview of the monitoring functions

The basic version of the device also provides monitoring functions. The following display, monitoring and control functions are available when the appropriate software is used:

- Temperature monitoring (overtemperature, low temperature, or cable break at a temperature sensor)
- Monitoring of drives with S.M.A.R.T. functionality
- Watchdog (hardware or software reset of the computer)
- Operating hours meter (information on total runtime)

SIMATIC IPC DiagBase software

Use the functions of the SIMATIC IPC DiagBase software included in the scope of delivery for local monitoring. Use the "DiagBase Management Explorer" application to obtain a clear overview of the controls. Use the DiagBase Alarm Manager to receive notifications about individual alarms.

Note

For more information on SIMATIC IPC DiagBase software functionality, please refer to the relevant Online Help.

SIMATIC IPC DiagMonitor software

The SIMATIC IPC DiagMonitor software is available in addition (not included in the scope of delivery). This monitoring software comprises:

- The software for the stations to be monitored.
- A library for creating user-specific applications.

Note

SIMATIC IPC DiagMonitor can be ordered using the Siemens online ordering system (<https://mall.industry.siemens.com>). For more detailed information about SIMATIC IPC DiagManager, refer to the corresponding product documentation.

4.3.1.2 Temperature monitoring/display

Temperature monitoring

Three temperature sensors monitor the temperature of the device at several positions:

- Processor temperature
- Temperature in proximity to the RAM ICs/blocks
- Temperature of the basic module

A temperature error is triggered when one of the three temperature values exceeds the set temperature threshold and the following reaction is initiated:

Reaction	Option
The DiagBase or DiagMonitor software is enabled	None

The temperature error is retained in memory until temperatures have fallen below the thresholds and it is reset by one of the following measures:

- Acknowledgment of the error message by the monitoring software
- Restart of the device

4.3.1.3 Watchdog (WD)

Configuration

You configure the watchdog with the DiagBase or DiagMonitor software.

Function

The watchdog is able to monitor system runtime and informs the user about the different reactions that are triggered if the system does not respond to the watchdog within the specified monitoring time.

A watchdog alarm is retained after a restart and is reset and logged by the DiagBase or DiagMonitor software. The watchdog configuration is retained in the process.

Watchdog reactions

The following reactions can occur if the watchdog is not addressed within the set time:

Option	Reaction
Reset on	Executes a hardware reset when the watchdog expires
Reset off	Executes no action when the watchdog expires
Restart	Restarts the operating system when the watchdog expires
Shutdown	Shuts down the operating system when the watchdog expires

NOTICE

"Reset on" option

The "Reset on" option immediately triggers a hardware reset that may result in loss of data under Windows and damage to the installation.

Watchdog monitoring times

The hardware supports the following times:

- Normal mode: 94 ms, 210 ms, 340 ms, 460 ms, 590 ms, 710 ms, 840 ms and 960 ms.
- Macro mode: 2s, 4s, 6s, 8s, 16s, 32s, 48s and 64s.

Set the monitoring times in SIMATIC Diagnostics Management as integer in the range from 4 to 64 seconds.

Note

Contact Customer Support for a detailed description of the Watchdog functions.

4.3.1.4 Battery monitoring

The installed backup battery has a limited service life, see section "Replacing the backup battery (Page 80)". A two-tier battery monitoring checks the status of the backup battery. The SIMATIC DiagBase and SIMATIC DiagMonitor diagnostic software determines the status of the backup battery.

When the first warning level is reached, the battery for buffering CMOS data still has a remaining service life of at least one month.

4.3.2 Buffer memory NVRAM

The motherboard is equipped with an NVRAM that applications can use to back up data in the event of a power failure. Failure of the supply voltage for a duration longer than 5 ms is indicated by the DC FAIL signal.

At least enough time is provided for copying data to the NVRAM so that 128 KB can be backed up with the full configuration.

A memory window with a maximum size of 512 KB can be displayed by means of PCI address register. The base address is initialized via the BIOS (see section "Input/output address areas (Page 122)").

A corresponding function is implemented there for using the NVRAM with a soft PLC.

Operating the device

The device variants differ with regard to their dimensions, display size, and touch sensors (single-touch sensor / multi-touch sensor).

The example in the following figure shows the front view of the 7" touchscreen variant.

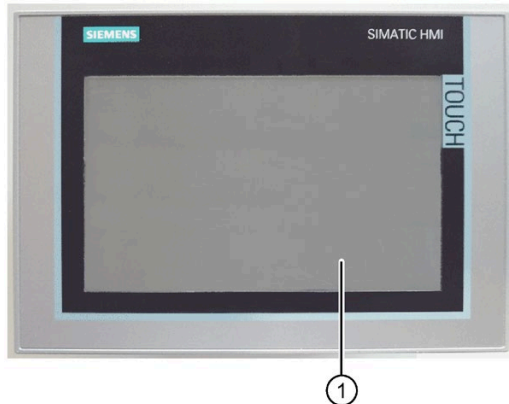

- ① Display with touch screen

5.1 Operator input options

Depending on your device and the connected I/O devices, the following operator input options are available:

- Touch screen for touch device

! CAUTION

Unintentional actions with touch screen operation

If you touch the touch screen while system-internal processes are running, unintended reactions of the device might be triggered.

Do not touch the screen in the following situations:

- During the boot process
- When plugging or unplugging USB components
- While Scandisk is running
- During a BIOS update

- Screen keyboard for touch device
- External keyboard, connected via USB
- External mouse, connected via USB

5.2 IPC Driver and Tools

Panel description - Panel Drivers and Tools software

The SIMATIC IPC PDT software installs the "IPC Configuration Center" and, optionally, the "IFP Ethernet Monitor" software.

The existing hardware components are automatically detected by the associated software.

The most important features of the software are:

- Dialog-guided installation
- Configuration via the IPC Configuration Center of:
 - Brightness
 - Screen saver
 - Tools
 - Touch settings
 - Ethernet Monitor settings

All other functions are described in the IPC Panel Driver and Tools operating manual.

5.3 Operating a device with resistive single-touch screen

Application-specific user interface elements, for example buttons, are shown on the display. Tapping a button with your finger activates the function assigned to the button.

WARNING

Personal injury and damage to property due to incorrect operation

Incorrect operations at the touch screen cannot be excluded. Such actions may lead to personal injury or damage to the machine or plant.

Take the following precautions:

- Configure the plant so that safety-related functions are not operated with the touch screen.
- Always touch only a single point on the touch screen.
- Never use the touch screen to control safety-related functions.
- Calibrate the touch screen regularly.
- Switch off the device for cleaning and maintenance.
- Make sure that the touch screen is kept free of dirt.

NOTICE

Damage to the touch screen

- Touching the touch screen with pointed or sharp objects can damage it and lead to a significant reduction in service life or even total failure of the touch screen.
- Never touch the touch screen with pointed or sharp objects. Only touch the touch screen with your fingers, a touch stylus or an approved touch glove.

The following types of pressure are permissible:

- Using a plastic pen with a 1 mm radius at the point: 25 g.
- Using a silicone finger with a diameter of 1.6 cm: 50 g.

Note

Only touch one point on the touch screen and not several points at one time. as this may trigger unintended reactions.

Additional information

A "touch pen system", which is suitable for both single-touch and multi-touch screens, is available on the Internet (<http://www.siemens.com/automation/mall>) (6AV2181-8AV20-0AX0).

5.4 Operating a device with capacitive multi-touch screen

You operate the multi-touch screen with one or multiple fingers.

 **WARNING**

Personal injury or property damage due to no earth connection

An inadequate earth connection or the lack of one may cause malfunction of the capacitive touch screen. Functions may not work properly. This can result in personal injury or property damage.

- Always connect the device to an earth conductor.
- The earth conductor from the device must be connected directly to earth with low impedance (short connection, minimum cross-section $2.5 \text{ mm}^2 = \text{AWG}14$).

You can find additional information on connecting the earth conductor in the section "Connecting the protective earth (Page 51)".

 **WARNING**

Personal injury or property damage due to maloperation

Incorrect operation of devices with a touch screen can occur. This can result in personal injury or property damage.

Take the following precautions:

- Configure the plant so that safety-related functions are not operated with the touch screen.
- Switch off the device for cleaning and maintenance.

! WARNING**Danger of malfunction due to improper execution of gestures on the touch screen**

If gestures are executed incorrectly on the touch screen with multi-touch function, these gestures might not be recognized or could be recognized incorrectly. The entries made are then not implemented by the device or are implemented incorrectly or in an unintended manner.

Incorrect execution of multi-touch functions can lead to errors in the operation of the plant and thus to physical injury.

Note the following when operating the touch screen with multi-touch function:

- The touch screen reacts to contact on its surface, not to pressure.
- When using a touch pen: Operate the touch screen only with a touch pen for capacitive touch.
- Avoid unintended multiple touches, for example, with your knuckles.

Before you start to operate the device, make sure you are familiar with the multi-touch functions of the Windows operating system, as well as with the application to be used and its functions. Ensure that the gestures which the user executes on the multi-touch display are recognized by the application. It is possible that certain gestures need to be trained beforehand.

Notes on operation

Note when operating the multi-touch screen:

- Surface contact with a diameter of about 5 to 20 mm is required for an operator action to be detected.
- An operation with gloves with a material thickness of <2 mm is detected in most cases. However, check the usefulness of the gloves you are using.
- To avoid incorrect operation, certain inputs are ignored and blocked from further entry:
 - Simultaneous operation with more than 5 fingers.
 - Surface contact with a diameter of > 3 cm, for example, resting the palm of the hand on the touch screen
 - As soon as the touch screen is no longer touched, input is possible again.

Functions of the multi-touch screen

General functions

- Detection of up to 5 finger touches at a time.
- Detection of gestures that are supported by the operating system or the software installed on the device.

Note

Multi-touch operation can provide advanced features or pose limitations depending on the operating system and the software installed on the device. Read the corresponding documentation.

- You do not need to calibrate the touch screen. Some operating systems do offer touch calibration. However, this calibration does not lead to improved accuracy.

Security functions in an industrial environment

The touch screen is locked for security reasons when the following happens:

- There is a conductive liquid on the touch screen with ground contact via the enclosure or the operator, for example.
- Electromagnetic interference is present that exceeds the specification according to EN 61000-4-2.

Once the interference is over, the touch screen is no longer locked.

Additional information

A "touch pen system", which is suitable for both single-touch and multi-touch screens, is available on the Internet (<http://www.siemens.com/automation/mall>) (6AV2181-8AV20-0AX0).

Device expansion and parameter assignment

6.1 Open the device.

Requirement

- The device is disconnected from the power supply.
- All cables have been disconnected from the device.
- The device has been removed from the control cabinet.
- A T10 screwdriver

Procedure – Opening the 7" and 9" single-touch devices

Note

The drive is located on the underside of the device cover.

- Carefully open the device.
- You cannot set the device cover down because of the connecting cable of the drive.
- You first have to pull out the connection plug in order to completely remove the device cover.
- Read the information in section "Replacing the drive (Page 82)".

	<p>1 Remove the marked screws</p> <p>2 Open the device cover at the back and set it and the drive vertically against the device wall. Lay the cover aside.</p> <p>Notice: Connection plug and board could be damaged.</p> <ul style="list-style-type: none"> • Ensure that the device cover does not fall down. • Remove the connection plug from the drive.
--	---

6.1 Open the device.

Procedure – Opening the 12", 15" and 19" single-touch devices

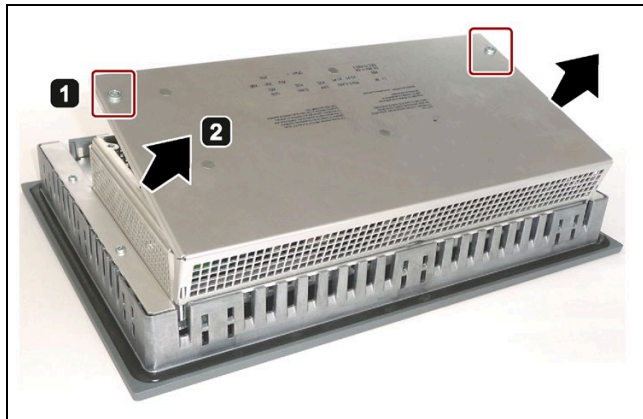
	<p>1 Remove the marked screws</p>
	<p>2 Open the device cover at the back and set it and the drive vertically against the device wall. Prop up the device cover.</p> <p>Notice: Connection plug and board could be damaged.</p> <ul style="list-style-type: none"> • Ensure that the device cover does not fall down. • Remove the connection plug from the drive.

Procedure – Opening the multi-touch device

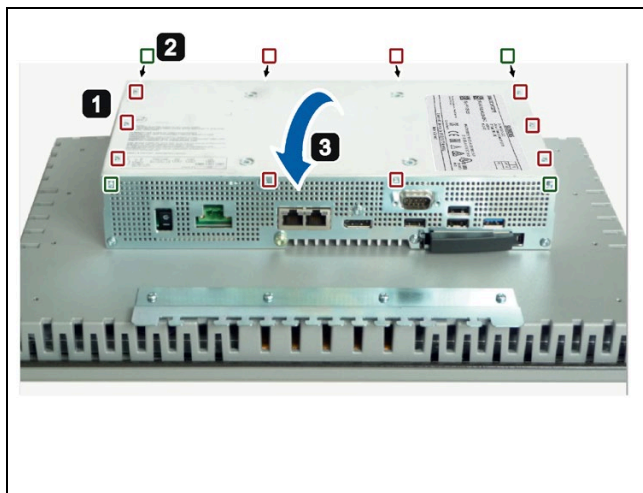
	<p>1 Remove the screws marked in red.</p>
	<p>2 Loosen the screws marked in green.</p>
	<p>3 Open the device cover at the front and set it and the drive vertically against the device wall. Prop up the device cover.</p> <p>Notice: Connection plug and board could be damaged.</p> <ul style="list-style-type: none"> • Ensure that the device cover does not fall down. • Remove the connection plug from the drive.

Procedure - closing the device.

Close the device in reverse order.

6.2 Installing and removing CFast cards

The device has a slot for a CFast card on the side with the interfaces. Always use SIMATIC IPC CFast cards for industrial applications.

NOTICE

Damage to the device

The CFast and CompactFlash connections are not compatible. The device is damaged.
Use the slot described here exclusively for a CFast card.

Note

Note the following:

- Always insert a CFast card version 02 or higher.
- Always replace a CFast card with a card of the same or higher version.
- The production version can be found on the CFast card (see marking).



Requirement

- The device is switched off.
- SIMATIC IPC CFast card that is approved for industrial applications.

Procedure

Installation

NOTICE

Inserting a memory card

If you are using the memory card in a device installed in a system, you must observe the safety regulations for work on electrical systems.

Insert the CFast card into the slot, working carefully and without applying excess force.

1. Release the lock of the cover.
Push against the cover in the direction indicated. Open the cover completely.
2. Insert the CFast card into the slot as shown in the figure.
Push CFast card into the slot until it snaps into place (ball-point pen mechanism).
3. Close and lock the cover.

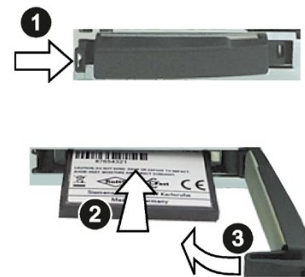

Similar to figure

Removal

Remove the CFast card from the memory slot by pushing it in until it is ejected by about 5 mm (ball-point pen mechanism).

Proceed in reverse order.

Device maintenance and repairs

7.1 Maintenance

To maintain high system availability, we recommend the preventative replacement of those PC components that are subject to wear. The table below indicates the intervals for this replacement.

Component	Replacement interval:
Hard disk drive	3 years
CMOS backup battery	5 years
SSD	Depends on the type of use ¹

¹ The interval for replacement depends greatly on the type of use. A specific interval cannot be given.

All drives are monitored with the software tools DiagBase or DiagMonitor on the basis of their SMART status. As soon the SMART status of the HDD or SSD switches to "Not OK", a message is sent in DiagBase or DiagMonitor, or when you start up the PC. You should then back up your data and replace the drive.

7.2 Repair information

Carrying out repairs

Only qualified personnel are permitted to repair the device.

 WARNING
<p>Unauthorized opening and improper repairs on the device may result in substantial damage to equipment or endanger the user.</p> <ul style="list-style-type: none"> • Always disconnect the power plug before you open the device. • Only install system expansion devices designed for this device. If you install other expansion devices, you may damage the device or violate the safety requirements and regulations on RF suppression. Contact your technical support team or where you purchased your PC to find out which system expansion devices may be installed.

If you install or exchange system expansions and damage your device, the warranty becomes void.

 **CAUTION**

Electrostatic sensitive devices (ESD)

The device contains electronic components which are destroyed by electrostatic charges. This can result in malfunctions and damage to the machine or plant.

Make sure you take precautionary measures even when you open the device, for example, when opening device doors, device covers or the housing cover. For more information, refer to the chapter "ESD Guideline (Page 93)"

Limitation of liability

All technical specifications and approvals of the device only apply if you use expansion components that have a valid CE approval (CE mark). The installation instructions for expansion components in the associated documentation must be observed.

UL approval of the device only applies when the UL-approved components are used according to their "Conditions of Acceptability".

We are not liable for functional limitations caused by the use of third-party devices or components.

Tools

For information on tools to open the device, see section "Opening the device". You can make repairs on the device with the following tools:

- T20 screwdriver for protective conductor connection and enclosure
- T10 screwdriver for all of the remaining screws

Safety assessment

Carry out a safety inspection for functions relevant to safety on the entire system, including all safety-related components.

7.3 Cleaning the Device Front

The device is designed for low-maintenance operation. You should still clean the device front regularly, however.

CAUTION

Unwanted reactions when cleaning the device

You risk unintentional actuation of control elements if you clean the device while it is switched on.

You may possibly trigger unwanted actions of the device or controller that are liable to cause personal injury or damage to the machinery.

Always switch off the device before you clean it.

Cleaning Agents

NOTICE

Damage to the HMI device caused by impermissible cleaning agents

Impermissible and unsuitable cleaning agents may cause damage to the HMI device.

Only use a damp cloth for cleaning. Do not use the following cleaning agents:

- Aggressive solvents or scouring powder
- Steam jets
- Compressed air

Procedure

1. Switch off the device. This will not inadvertently trigger functions when touching the screen and/or the membrane keypad.
2. Moisten only the cleaning cloth, do not spray liquids directly onto the device.
3. Clean the enclosure surface with a damp cloth and make sure that no water enters the device.

7.4 Installing and removing hardware

7.4.1 Replacing the backup battery

Prior to replacement

 WARNING
Risk of explosion and release of harmful substances
Improper handling of lithium batteries can result in an explosion of the batteries. Explosion of the batteries and the released pollutants can cause severe physical injury. Worn batteries jeopardize the function of the device.
Note the following when handling lithium batteries:
<ul style="list-style-type: none">• Replace the battery every 5 years.• Replace the lithium battery only with an identical battery or types recommended by the manufacturer. The order number is A5E34345932.• Do not throw lithium batteries into fire, do not solder on the cell body, do not recharge, do not open, do not short-circuit, do not reverse polarity, do not heat above 100°C and protect from direct sunlight, moisture and condensation.

NOTICE
Disposal of batteries and rechargeable batteries
Do not dispose of used batteries and rechargeables in household waste. Users are obliged by law to return used batteries and rechargeable batteries. Used batteries and rechargeable batteries pollute the environment as hazardous waste. Improper disposal of used batteries and rechargeables renders you liable to prosecution.
When disposing of rechargeable batteries, observe the following:
<ul style="list-style-type: none">• Dispose of used batteries and rechargeable batteries separately as hazardous waste in accordance with local regulations.• You can return used batteries and rechargeables to public collection points and wherever batteries and rechargeable batteries of the type in question are sold.• Label the battery container with "Used batteries and rechargeable batteries".

Requirement

- The device is disconnected from the power supply.
- The device is opened.

Procedure - removal

NOTICE
Time may be deleted The time will be deleted if it takes you longer than 30 seconds to replace the battery. The device is no longer synchronous. Time-controlled programs will no longer run or will run at the wrong time. This may damage the plant. Reset the time for the device.

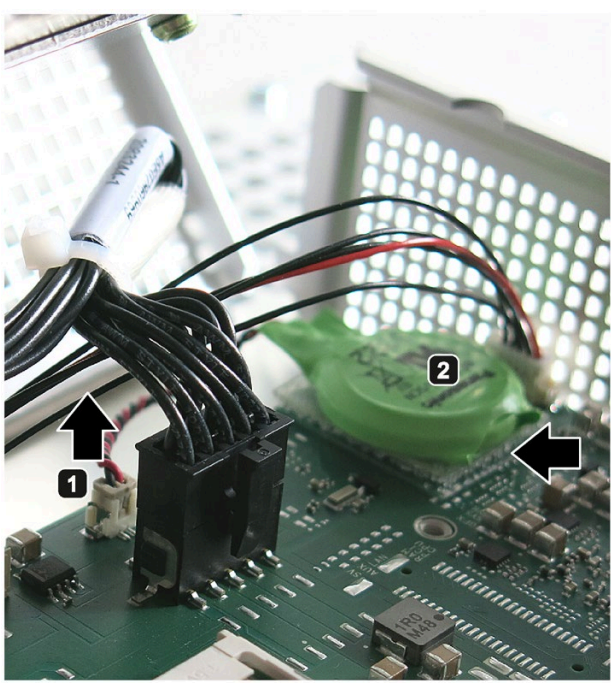
	1 Pull out the connector.
	2 Remove the battery with the attached Velcro from the Velcro fastener on the motherboard. Remove also the Velcro fastener on the motherboard.

Procedure - installation

1. To install the replacement battery, follow the steps for removing the battery in the reverse order. A Velcro fastener is provided with the replacement battery.
2. Stick a Velcro fastener on the battery.
3. Replace the Velcro on the motherboard. When sticking on the new Velcro, pay attention to the position mark.
4. Attach the replacement battery with the Velcro to the Velcro on the motherboard.

7.4.2 Replacing the drive

Carry out the work step if you want to change an SSD. This section shows the procedure based on an example with the 12" device.

Requirement

- The device is opened.
- An SSD
- A T10 screwdriver

Procedure - removal

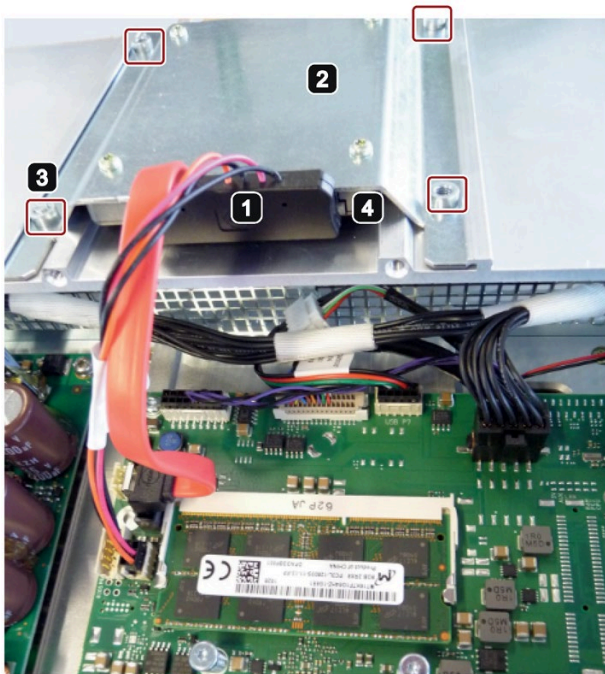

- 1** Pull out the connector.
- 2** Set aside the device cover upside down: The drive is at the top.
- 3** Remove the marked screws.
- 4** Remove the drive from the support plate.

Procedure - installation

For installation, follow these steps in reverse and close the device.

7.5 Installing the software

7.5.1 Reinstalling the operating system

Information on your operating system is available on the Internet and on the supplied USB stick:

- Microsoft® Windows® 7
(<https://support.industry.siemens.com/cs/ww/de/view/109749497/en?dl=en>)
- Microsoft® Windows Embedded Standard® 7
(<https://support.industry.siemens.com/cs/ww/de/view/109749499/en?dl=en>)
- Microsoft® Windows® 10
(<https://support.industry.siemens.com/cs/ww/de/view/109749498/en?dl=en>)

7.6 Backing up data

We recommend the software tool **SIMATIC IPC Image & Partition Creator** (as of V3.5.1) to back up data under Windows. This tool provides convenient and efficient functions for backing up and restoring the full content of memory cards, hard disks and individual partitions (images).

The **SIMATIC IPC Image & Partition Creator** can be ordered using the Siemens online ordering system (<https://mall.industry.siemens.com>). For more information about SIMATIC IPC Image & Partition Creator, refer to its product documentation.

7.7 Recycling and disposal

The devices described in these operating instructions can be recycled thanks to their low level of pollutants. Observe the local statutory requirements for environmentally sound recycling and disposal of your old devices. Alternatively, you can use a certified disposal service company.

Technical specifications

8.1 Certificates and approvals

Note**Possible approvals**

The following overview shows possible approvals.

Only the approvals specified on the device apply to the device itself.



The device meets the guidelines listed in the following sections.

EU Declaration of Conformity

The associated declaration of conformity is available on the Internet at the following address:
EC declaration of conformity, UL approval for Canada/USA
(<http://support.automation.siemens.com/WW/view/en/48958203>).

DIN ISO 9001 certificate

The Siemens quality management system for all production processes (development, production and sales) meets the requirements of DIN ISO 9001:2000.

This has been certified by DQS (the German society for the certification of quality management systems).

Certificate registration no. DE-000656 QM08

Software license agreements

If the device is supplied with preinstalled software, you must observe the corresponding license agreements.

8.1.1 UL HAZ. LOC. and ATEX/IECEX

cULus HAZ. LOC. approval in file E223122



The following approvals are available for the device when specified as such on the nameplate:

Underwriters Laboratories Inc. according to

- UL 508 (Industrial Control Equipment)
- CSA C22.2 No. 142 (Process Control Equipment)
- ANSI/ISA 12.12.01 (Hazardous Location)
- CSA-213 (Hazardous Location)

Approved for use in

- Class I, Division 2, Group A, B, C, D T4
- Class I, Zone 2, Group IIC T4

Observe the following note:

Note

This product must be installed according to the NEC (National Electric Code) stipulations.

When used in environments according to class I, division 2 (see above), the device must be mounted in an enclosure that corresponds to at least IP54 according to EN 60529.

ATEX and IECEX

Devices of category 3G for use in Zone 2 and devices of category 3D for use in Zone 22.

Note

For additional ATEX/IECEX-relevant information for Zone 2 and Zone 22, see (https://cache.industry.siemens.com/dl/files/172/19692172/att_861654/v1/A5E00352937_AK-V1-DO.pdf).

8.1.2 Ex approval

Observe the following standards for use in hazardous areas:

EN 60079-0 : 2012 + A11 : 2013, EN 60079-15 : 2010, IEC 60079-0 :2011 (Ed.6), + Corr.1. 2012 + Corr.2. 2013, IEC 60079-15 : 2010 (Ed. 4)

Specific conditions of use (for ATEX)

- The modules shall be installed in a suitable enclosure providing a degree of protection of at least IP54 according to EN 60079-15, taking into account the environmental conditions under which the equipment will be used.
- Provisions shall be made to prevent the rated voltage from being exceeded by transient disturbances of more than 119 V.

Specific conditions of use (for IECEx)

- The equipment shall only be used in an area of not more than pollution degree 2, as defined in IEC 60664-1.
- The modules shall be installed in a suitable enclosure providing a degree of protection of at least IP54 according to IEC 60079-15, taking into account the environmental conditions under which the equipment will be used.
- Provisions shall be made to prevent the rated voltage from being exceeded by transient disturbances of more than 119 V.

Switch:

SW1 On/Off switch - will not be used during operational maintenance

The device has to be used in pollution degree 2 environment only.

Use copper supply wires with a diameter of at least 0.75 mm² (= AWG18).

8.1.3 UL approval

UL approval



- Underwriters Laboratories (UL) according to standard UL 61010-2-201 (PROG.CNTRLR.) Second Edition, File E85972
 - Canadian National Standard CAN/CSA-C22.2 No. 61010-2-201 Second Edition
 - ANSI/ISA 12.12.01 (Hazardous Location)
 - CSA-213 (Hazardous Location)
- Approved for use in
- Cl. I Div. 2, GP. A, B, C, D T4
 - Cl. I, Zone 2, GP. IIC T4

ATEX/IECEx - approval for multi-touch devices



Additionally to the installation instructions in the user manual of IPC477D the following specifications must be observed for installation in hazardous locations.

The device has to be used in pollution degree 2 environment only.

Use copper supply wires with a diameter of at least 0.75 mm² (= AWG18).

EN60079-0 (ATEX)

EN60079-15 (ATEX)

EN60079-31 (ATEX)

IEC60079-0 (IECEx)

IEC60079-15 (IECEx)

IEC60079-31 (IECEx)

	II 3 G	Ex nA IIC Tx Gc
	II 3 D	Ex tc T 70 °C Dc

Approval Mark ATEX 15ATEX0119X and/or IECEx DEK 15.0080X

Note

Installation

You have to install the device so that the complete device conforms to IP65.

The front panel of the mounted device conforms to IP65.

 CAUTION
<p>DC-Version</p> <p>If a main circuit breaker for DC-supply should be installed in hazardous locations as described above it has to be intended for use in that area. Otherwise it must be installed in an area which is known to be non-hazardous.</p>

 WARNING
<p>Risk of explosion when connecting or disconnecting the device</p> <p>EXPLOSION HAZARD</p> <p>WARNING - EXPLOSION HAZARD - Do not connect or disconnect while circuit is live unless area is known to be non-hazardous.</p>

This equipment is suitable for use in Class I, Division 2, Groups A, B, C and D or non-hazardous locations only.

 WARNING
<p>Warning - Explosion Hazard - Batteries Must Only Be Changed In An Area Known To Be Non-Hazardous.</p> <p>The lithium battery shall only be replaced by a trained technician.</p>

 WARNING
<p>Replacing components</p> <p>EXPLOSION HAZARD</p> <p>WARNING - SUBSTITUTION OF COMPONENTS MAY IMPAIR SUITABILITY FOR CLASS I, DIVISION 2 OR ZONE 2.</p>

Plant designation	Description	Degree of protection
Hard Disk Drive on Motherboard	HDD	Brushless Motor

FCC (USA) and ICES (Canada) Compliance

USA	
Federal Communications Commission Radio Frequency Interference Statement	This equipment has been tested and found to comply with the limits for a Class A digital device, pursuant to Part 15 of the FCC Rules. These limits are designed to provide reasonable protection against harmful interference when the equipment is operated in a commercial environment. This equipment generates, uses, and can radiate radio frequency energy and, if not installed and used in accordance with the instruction manual, may cause harmful interference to radio communications. Operation of this equipment in a residential area is likely to cause harmful interference in which case the user will be required to correct the interference at his own expense.
Shielded Cables	Shielded cables must be used with this equipment to maintain compliance with FCC regulations.
Modifications	Changes or modifications not expressly approved by the manufacturer could void the user's authority to operate the equipment.
Conditions of Operations	This device complies with Part 15 of the FCC Rules. Operation is subject to the following two conditions: (1) this device may not cause harmful interference, and (2) this device must accept any interference received, including interference that may cause undesired operation.

CANADA	
Canadian Notice	This Class A digital apparatus complies with Canadian ICES-003 (A).
Avis Canadien	Cet appareil numérique de la classe A est conforme à la norme NMB-003 (A) du Canada.

8.1.4 Australia, Class A

RCM AUSTRALIA/NEW ZEALAND



This product meets the requirements of EN 61000-6-4:2007 Generic standards – Emission standard for industrial environments.

This product meets the requirements of the standard EN 61000-6-4:2007 Generic standards – Emission standard for industrial environments.



This product meets the requirements of Korean certification.

This product satisfies the requirement of the Korean Certification (KC Mark).

이 기기는 업무용(A급) 전자파 적합기기로서 판매자 또는 사용자는 이 점을 주의하시기 바라며 가정 외의 지역에서 사용하는 것을 목적으로 합니다.

Marine approvals

Note

- Marine approvals for 7", 9", and 12" single-touch devices
 - Marine approvals for 15" and 19" multi-touch devices
-

The following marine approvals are provided for the device. After acceptance, the certificates will be made available under the following address on the Internet: SIMATIC IPC277E certificates (<http://support.automation.siemens.com/WW/view/en/48958258/134200>)

- ABS American Bureau of Shipping (USA)
- BV Bureau Vertias (France)
- DNV GL (Norway/Germany)
- LR Lloyds Register of Shipping
- Class NK Nippon Kaiji Kyokai (Japan)
- China Classification Society (CCS)

8.2 Directives and declarations

8.2.1 Electromagnetic compatibility for industrial environments

Electromagnetic compatibility

This product meets the requirements of EC Directive 2014/30/EU "Electromagnetic Compatibility".

The device is designed for the following areas of application corresponding to the CE marking:

Scope of application	Requirements for	
	Interference emission	Immunity to interference
Industrial area	EN 61000-6-4	EN 61000-6-2

8.2.2 RoHs directive

This product meets the requirements stated in the RoHS directive (Restriction of Hazardous Materials): 2011/65/EU

Compliance with the directive has been reviewed according to the following standard:
EN 50581

8.2.3 ESD guideline

What does ESD mean?

An electronic module is equipped with highly integrated components. Due to their design, electronic components are highly sensitive to overvoltage and thus to the discharge of static electricity. Such electronic components or modules are labeled as electrostatic sensitive devices.

The following abbreviations are commonly used for electrostatic sensitive devices:

- ESD – Electrostatic sensitive device
- ESD – Electrostatic Sensitive Device as a common international designation

Electrostatic sensitive devices can be labeled with an appropriate symbol.



NOTICE

Damage to ESD from touch

Electrostatic sensitive devices, ESD, can be destroyed by voltages which are far below the human perception limit. If you touch a component or electrical connections of a module without discharging any electrostatic energy, these voltages may arise.

The damage to a module by an overvoltage can often not be immediately detected and only becomes evident after an extended period of operation. The consequences are incalculable and range from unforeseeable malfunctions to a total failure of the machine or system.

Avoid touching components directly. Make sure that persons, the workstation and the packaging are properly grounded.

Charge

Every person without a conductive connection to the electrical potential of his/her surroundings can be electrostatically charged.

The material with which this person comes into contact is of particular significance. The figure shows the maximum electrostatic voltages with which a person is charged, depending on humidity and material. These values conform to the specifications of IEC 61000-4-2.

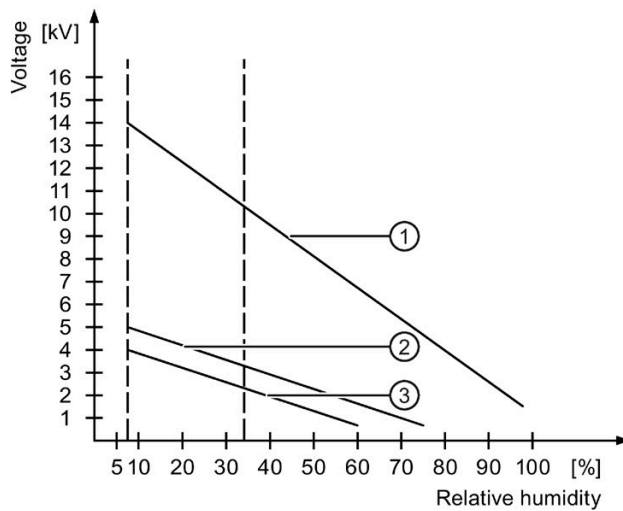

- ① Synthetic materials
- ② Wool
- ③ Antistatic materials such as wood or concrete

NOTICE
Grounding measures
There is no equipotential bonding without grounding. An electrostatic charge is not discharged and may damage the ESD.
Protect yourself against discharge of static electricity. When working with electrostatic sensitive devices, make sure that the person and the workplace are properly grounded.

Protective measures against discharge of static electricity

- Disconnect the power supply before you install or remove modules which are sensitive to ESD.
- Pay attention to good grounding:
 - When handling electrostatic sensitive devices, make sure that persons, the workstation and devices, tools and packaging used are properly grounded. This way you avoid static discharge.
- Avoid direct contact:
 - As a general rule, do not touch electrostatic sensitive devices, except in the case of unavoidable maintenance work.
 - Hold the modules at their edge so that you do not touch the connector pins or conductor paths. This way, the discharge energy does not reach and damage the sensitive components.
 - Discharge your body electrostatically before you take a measurement at a module. Do so by touching grounded metallic parts. Always use grounded measuring instruments.

8.3 Dimension drawings

8.3.1 Dimension drawing of 7" single-touch device

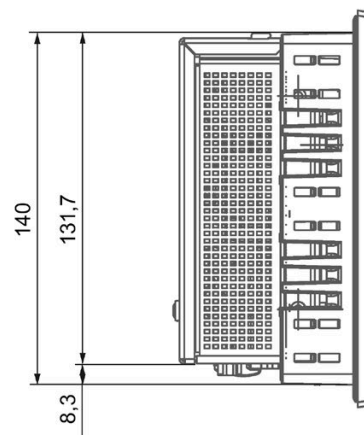
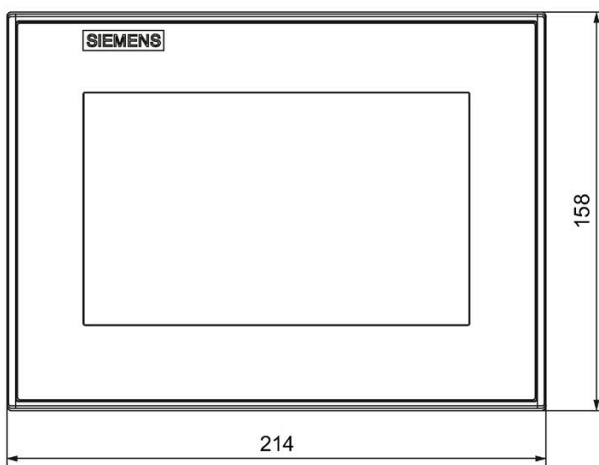
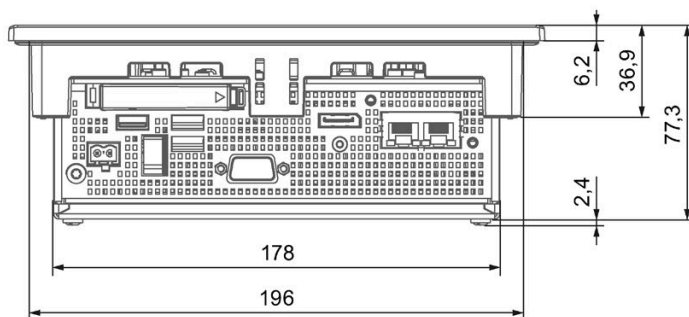

all dimensions in mm

8.3.2 Dimension drawing of 9" single-touch device

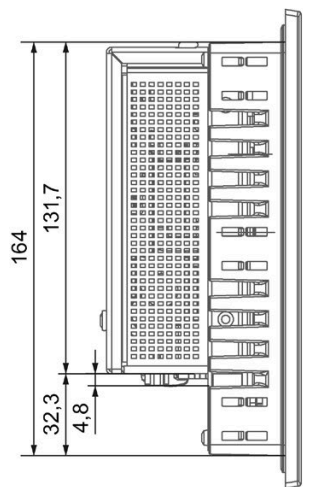
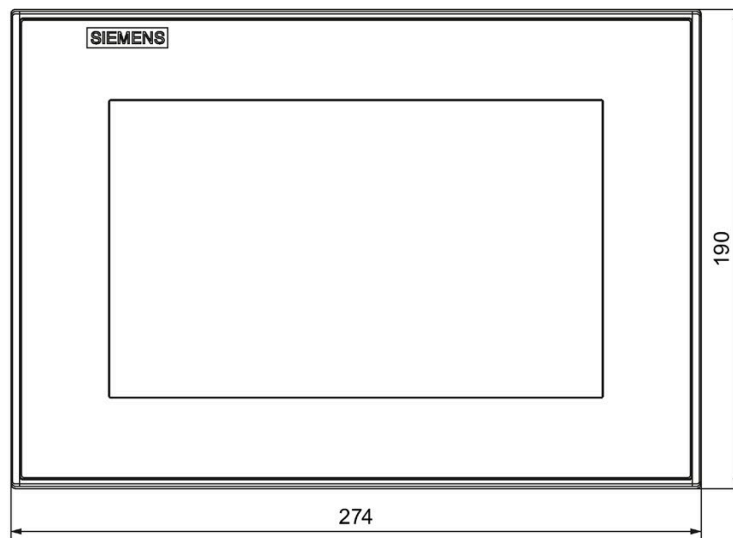
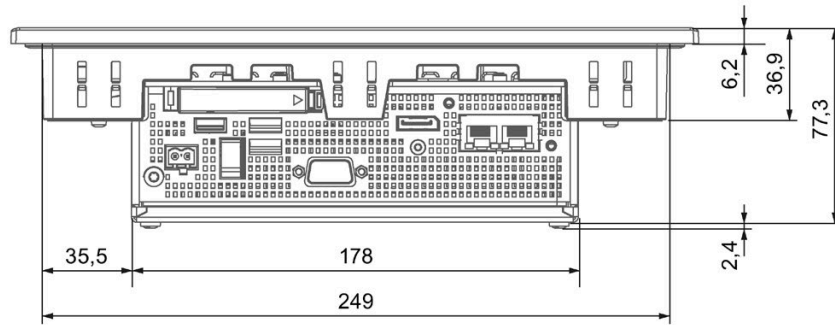

all dimensions in mm

8.3.3 Dimension drawing of 12" single-touch device

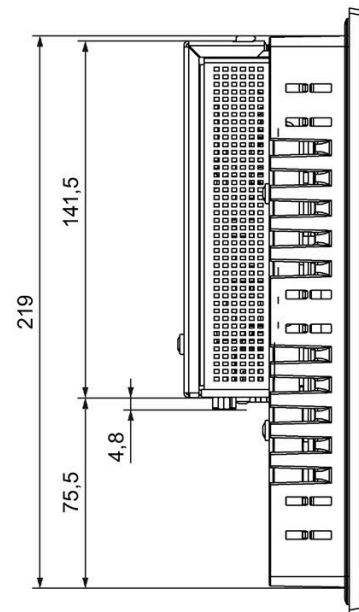
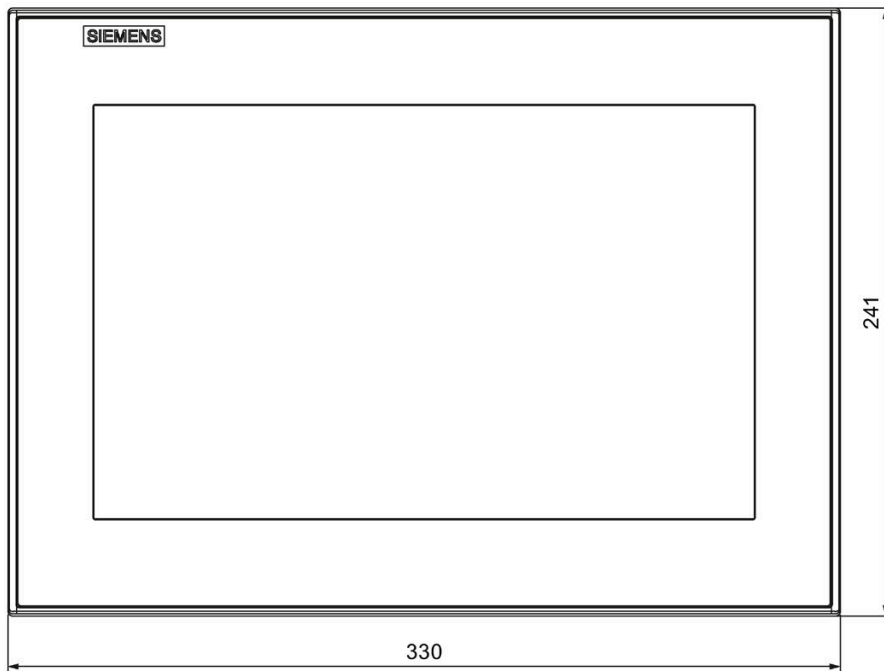
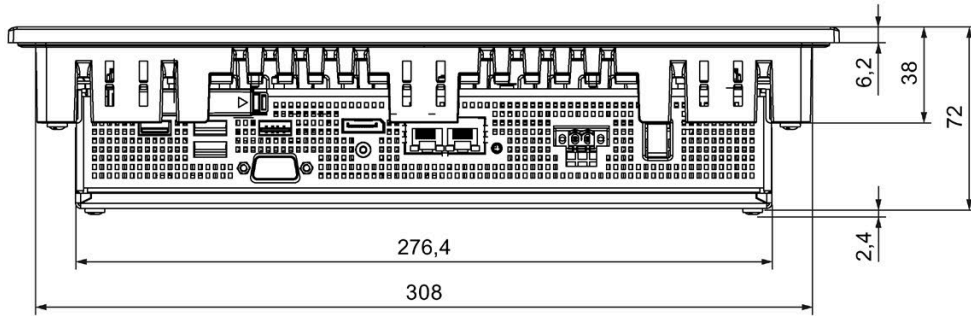

all dimensions in mm

8.3.4 Dimension drawing of 15" single-touch device

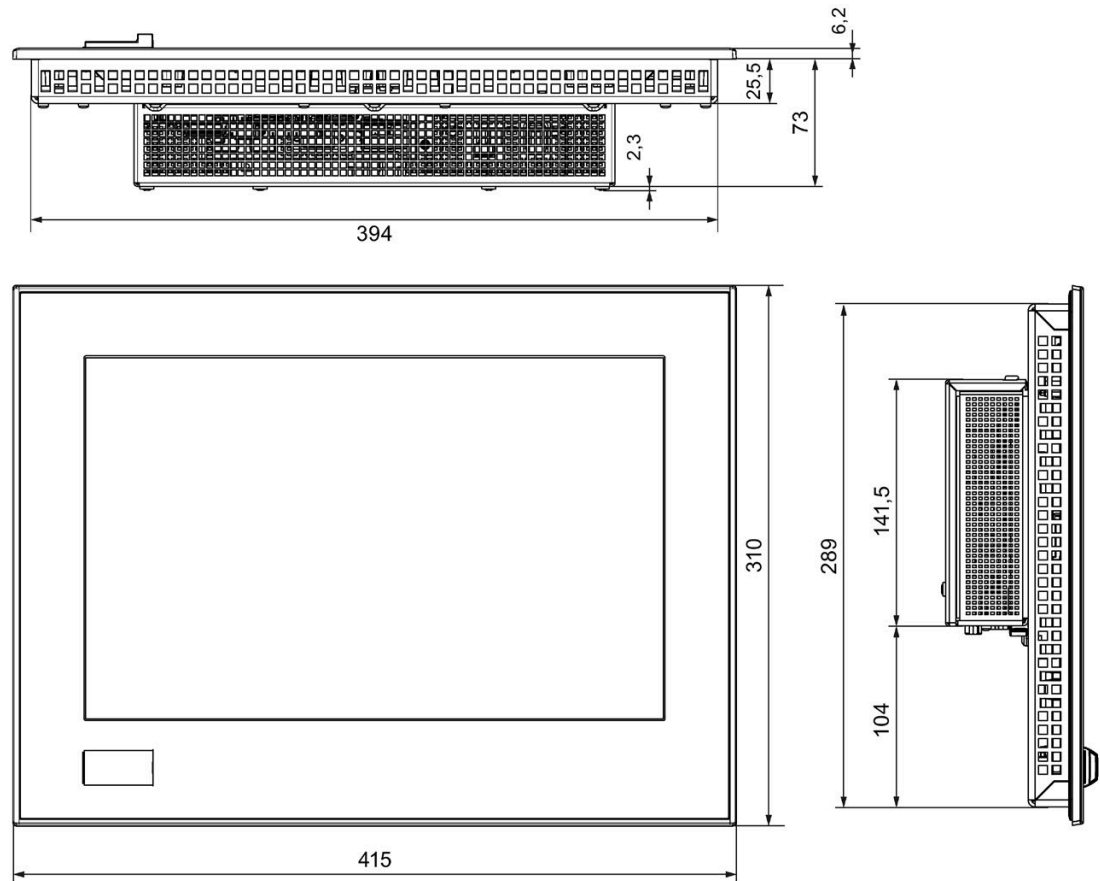

all dimensions in mm

8.3.5 Dimension drawing of 19" single-touch device

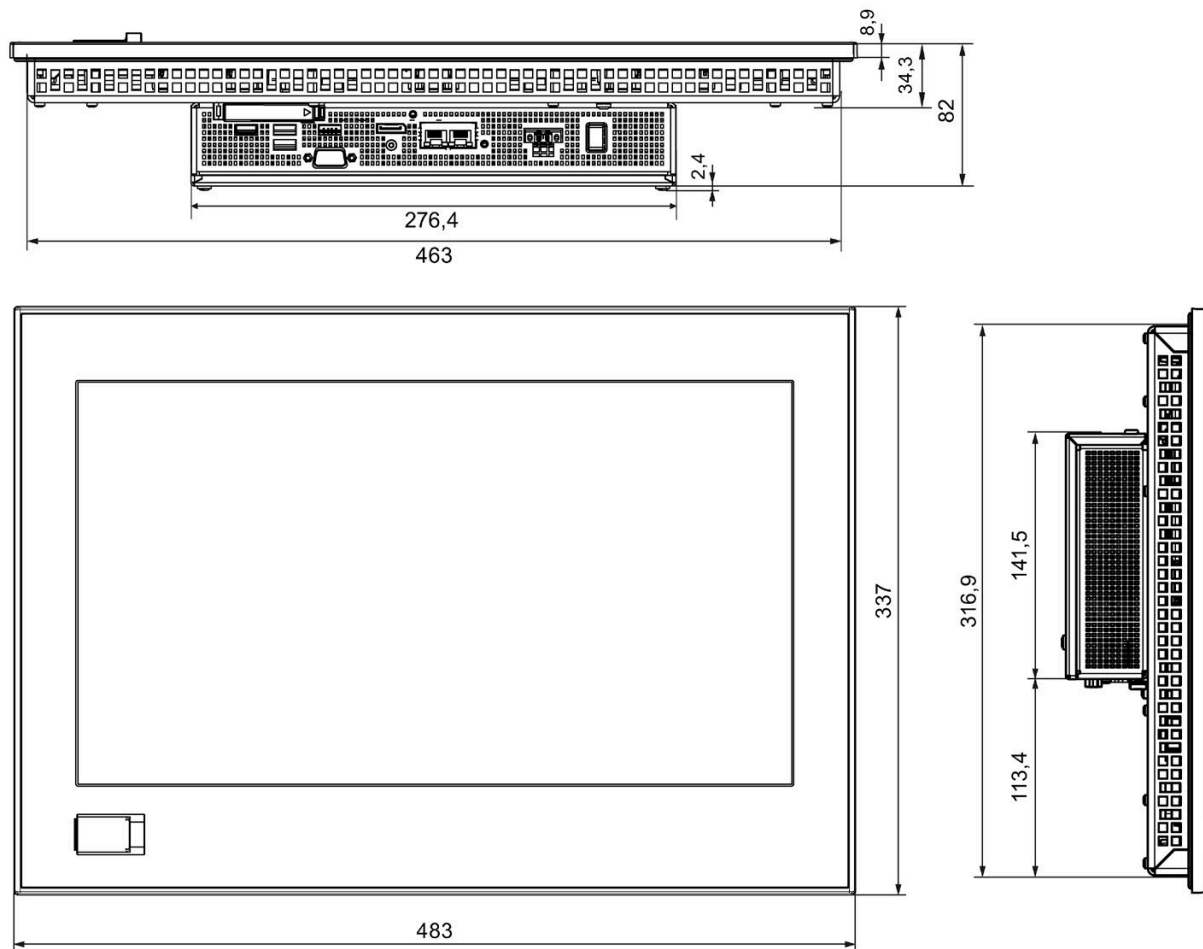

all dimensions in mm

8.3.6 Dimension drawing of 12" multi-touch device

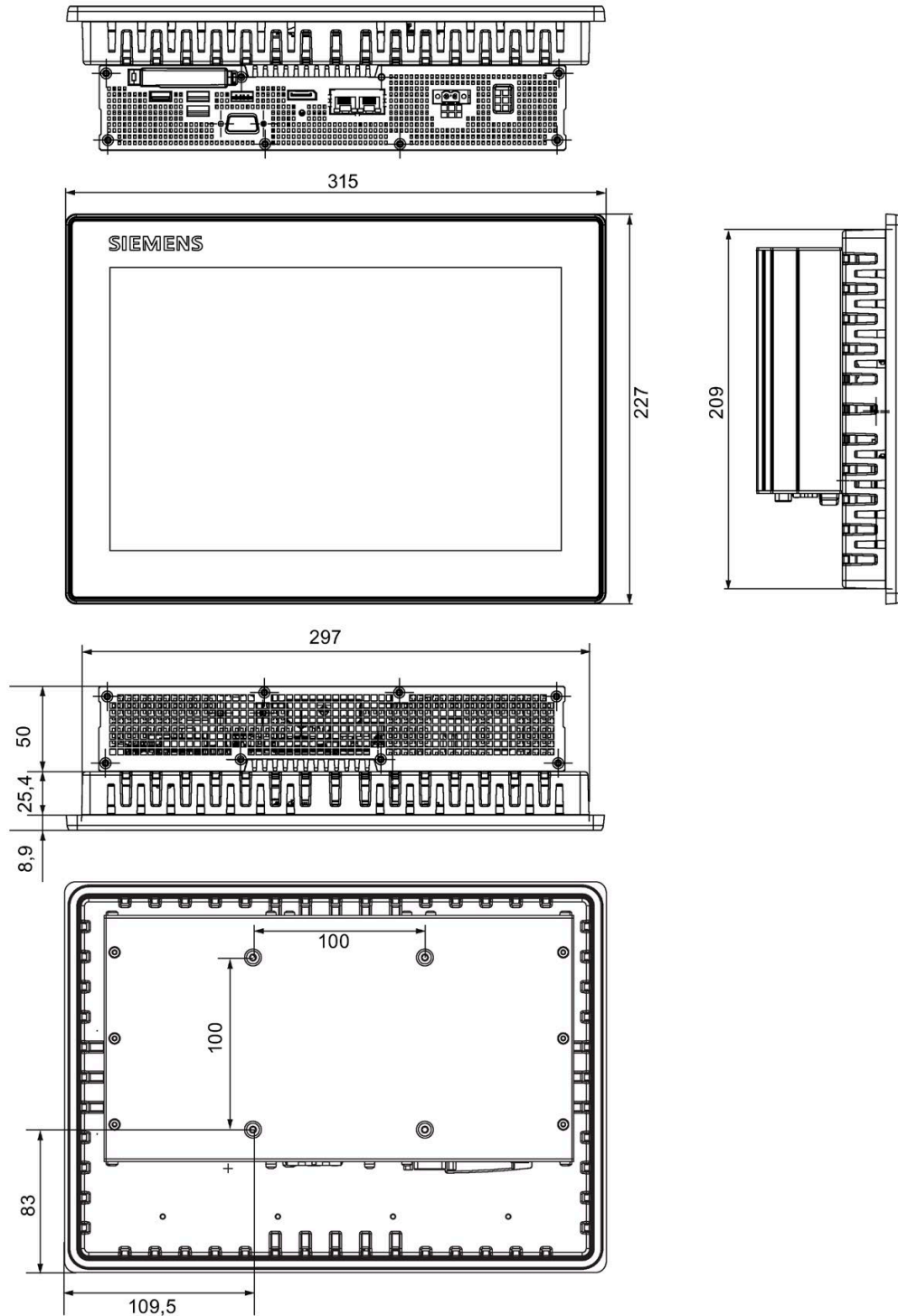

All dimensions in mm.

8.3.7 Dimension drawing of 15" multi-touch device

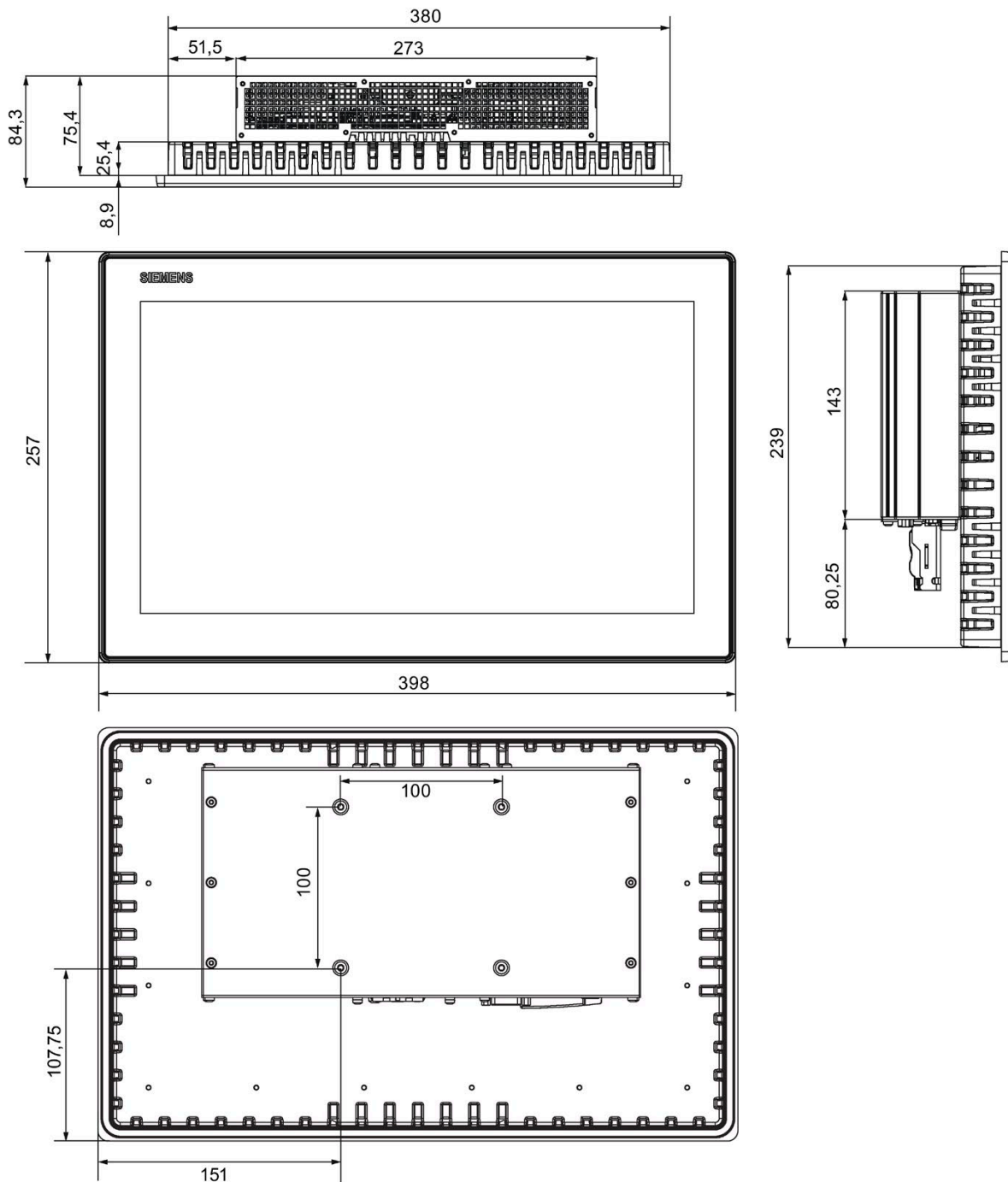

All dimensions in mm.

8.3.8 Dimension drawing of 19" multi-touch device

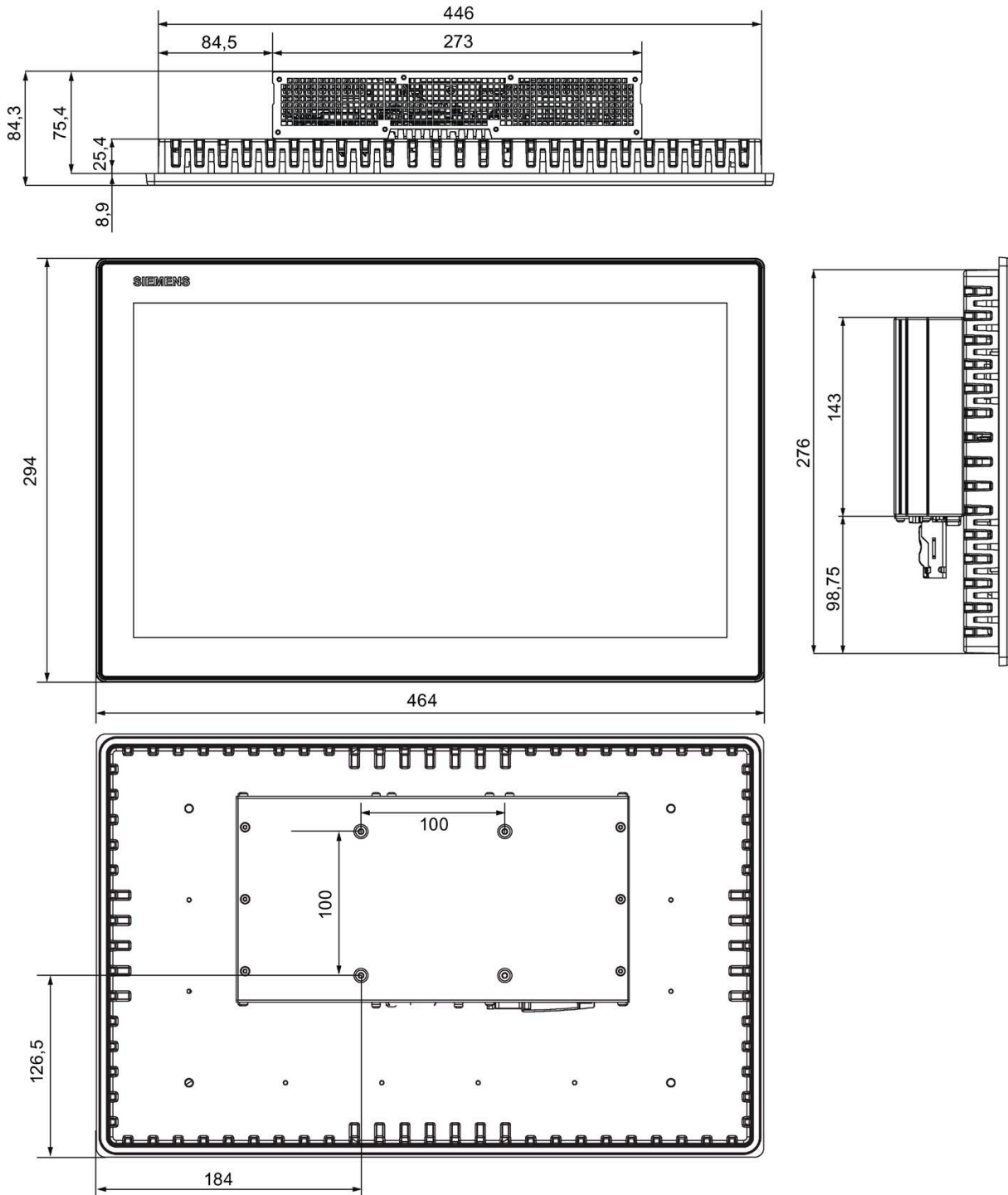

All dimensions in mm.

8.4 Technical specifications

8.4.1 General technical specifications

	Single-touch	Multi-touch
Weight		
<ul style="list-style-type: none"> • 7" device • 9" device • 12" device • 15" device • 19" device 	<ul style="list-style-type: none"> • Approx. 1500 g • Approx. 1950 g • Approx. 2750 g • Approx. 4000 g • Approx. 5700 g 	<ul style="list-style-type: none"> • - • - • Approx. 2650 g • Approx. 5500 g • Approx. 6500 g
Power supply ¹	24V DC (19.2 to 28.8 V)	
Brief power failure according to Namur	Min. 20 ms (DC) Max. 10 events per hour; min. 1 s recovery time	
Max. power consumption (DC):	Continuous current	Continuous current
<ul style="list-style-type: none"> • 7" display • 9" display • 12" display • 15" display • 19" display <p>The current may differ depending on the operating mode and extensions.</p>	<ul style="list-style-type: none"> • 24 V, 1.1 A • 24 V, 1.2 A • 24 V, 1.4 A • 24 V, 1.9 A • 24 V, 1.9 A 	<ul style="list-style-type: none"> • - • - • 24 V, 1.4 A • 24 V, 1.9 A • 24 V, 1.9 A
Degree of protection	<ul style="list-style-type: none"> • IP 20 to IEC 60529 (enclosure) • IP 65 (front) 	
Protection class	Protection class I according to IEC 61140	
Safety specifications	EN 61010-1; EN 61010-2-201; UL 61010-1; UL 61010-2-201; CAN/CSA-C22.2 No. 61010-1; CAN/CSA-C22.2 No. 61010-2-201; UL 508; CAN/CSA-C22.2 No. 142	
Quality assurance	In accordance with ISO 9001	

¹ The device may only be connected to a 24 V DC power supply which meets the requirements of a safe extra-low voltage (SELV/PELV) in accordance with IEC/EN/DIN EN/UL 60950-1 or IEC/EN/DIN EN/UL 61010-2-201.

The power supply must fulfill the requirements of NEC Class 2 or LPS of IEC/EN/DIN EN/UL 60950-1 or Limited Energy according to IEC/EN/DIN EN/UL 61010-2-201.

Electromagnetic compatibility

Emission standard	EN 61000-6-4; CISPR 22 Class A; FCC Class A
Immunity with regard to conducted interference on the supply lines	± 2 kV in accordance with IEC 61000-4-4; burst ± 1 kV in accordance with IEC 61000-4-5; symmetrical surge ± 2 kV in accordance with IEC 61000-4-5; asymmetrical surge
Noise immunity on signal lines	± 2 kV in accordance with IEC 61000-4-4; burst; length > 3 m ± 2 kV in accordance with IEC 61000-4-5; symmetrical surge, length > 30 m
Immunity to electrostatic discharge	± 6 kV contact discharge at the front in accordance with IEC 61000-4-2 ± 4 kV housing contact discharge at the back in accordance with IEC 61000-4-2 ± 8 kV air discharge in accordance with IEC 61000-4-2
Immunity to RF interference	10 V/m, 80 to 2000 MHz 80% AM according to IEC 61000-4-3 3 V/m, 2 to 6 GHz 10 V, 9 kHz to 80 MHz according to IEC 61000-4-6
Immunity to magnetic fields	100 A/m, 50/60 Hz according to IEC 61000-4-8

Main circuit board

Processor	<ul style="list-style-type: none"> Intel Celeron N2807: Dual Core, 1.58 GHz, burst frequency 2.16 GHz, 1 MB 2nd level cache, 4.3W TDP Intel Celeron N2930: Dual Core, 1.83 GHz, burst frequency 2.16 GHz, 2 MB 2nd level cache, 7.5W TDP
Main memory	Memory modules without ECC: <ul style="list-style-type: none"> 4 GB DDR3L SODIMM 8 GB DDR3L SODIMM
Backup memory	512 KB NVRAM Of this, 128 KB of this can be backed up at full load in the buffer time of the power supply.

Drive, memory medium

Solid state drive, option (1 mounting space)	≥ 160 GB, 2.5" SATA SSD
CFast memory card, optional	<ul style="list-style-type: none"> 4 GB or 8 GB or 16 GB or > = 32 GB
Floppy and CD-ROM drive	External, can be connected via USB port ¹
USB stick	External, can be connected via USB port

¹ Only to device USB port, not via USB hub

Graphics

<p>Display, resolution</p>	<ul style="list-style-type: none"> • 7" screen diagonal with backlighting, resolution 800 × 480 pixels, WVGA, WGA (Wide VGA) • 9" screen diagonal with backlighting, resolution 800 × 480 pixels, WVGA, WGA (Wide VGA) • 12" screen diagonal with backlighting, resolution 1280 × 800 pixels, WXGA (Wide XGA) • 12" screen diagonal MT with backlighting, resolution 1280 x 800 pixels • 15" screen diagonal with backlighting, resolution 1280 × 800 pixels, WXGA (Wide XGA) • 15" screen diagonal MT with backlighting, resolution 1366 x 768 pixels • 19" screen diagonal with backlighting, resolution 1366 x 768 pixels • 19" screen diagonal MT with backlighting, resolution 1366 x 768 pixels
<p>Touch controller</p>	<p>Resistive Semtech controller ELO CTR-2216SU-AT-CHP-00 Touch screen analog resistive Touch force with test pen; 2 mm diameter: 5 N</p>
<p>Backlighting (MTBF) Half brightness life time, typical</p>	<p>LED</p> <ul style="list-style-type: none"> • 7" min. 80000 h at 50 °C, 50% brightness (single-touch) • 9" min. 80000 h at 50 °C, 50% brightness (single-touch) • 12" min. 50000 h at 50 °C, 50% brightness (single-touch and multi-touch) • 15" min. 80000 h at 50 °C, 50% brightness (single-touch) • 15" min. 70000 h at 50 °C, 50% brightness (multi-touch) • 19" min. 50000 h at 50 °C, 50% brightness (single-touch and multi-touch)
<p>Pixel error class in accordance with ISO 9241-307</p>	<p>II</p>

Interfaces

COM	<ul style="list-style-type: none"> • RS 232 ¹, max. 115 Kbps, D-sub connector, 9-pin • RS485 ^{1 2}/RS422 ¹ (optional), max. 115 kbps, D-sub connector, 9-pin
USB	<ul style="list-style-type: none"> • 7" and 9": 2 × USB 2.0, 1 × USB 3.0 maximum 6 Watt USB load • 12", 15" and 19": 3 × USB 2.0, 1 × USB 3.0 maximum 6 Watt USB load 3 × USB 2.0, maximum of 2 can be operated in high-current mode at the same time • 15"/19": 1 x front USB 2.0 high current
LAN interface X1 P1, RJ45 ³	Intel LAN Controller Springville i210 10, 100, 1000 Mbps, teaming ⁴
LAN interface X2 P1, RJ45 ³	Intel LAN Controller Springville i210 10, 100, 1000 Mbps, teaming ⁴
Keyboard, mouse	Connection via USB port

¹ In the BIOS setup, you can configure support for RS232 or RS422/RS485 for each COM port.
Available parameters:

- Autodirection
 - Onboard termination
 - Half-duplex or Full-duplex

² Termination can be set in BIOS.

³ For unique labeling, the LAN interfaces are numbered on the enclosure. The numbering by the operating system can differ.

⁴ Teaming can be set and initiated in the configuration interface. Jumbo frames, e.g. for the camera application, are not supported in teaming operation.
No teaming is possible in combination with Windows 10.

8.4.2 Environmental conditions

Climatic ambient conditions

For permitted mounting positions, see section Preparing for installation (Page 31).

Temperature, tested in accordance with IEC 60068-2-1, IEC 60068-2-2			
Temperature gradient in operation	Max. 10 °C/h, no condensation		
Ambient temperature in operation	7", 9" and 12"	15"	19"
<ul style="list-style-type: none"> When installed vertically in horizontal format When installed inclined, inclination vertical installation, inclination <math>\pm 45^\circ</math> When installed vertically in horizontal format 	0 ... 50 °C	0 ... 50 °C	0 ... 45 °C
	0 ... 50 °C	0 ... 45 °C	0 ... 45 °C
	0 ... 45 °C	0 ... 40 °C	0 ... 40 °C
Temperature during storage/transport	-20 to +60 °C		
Storage/transport, gradient	Max. 20 °C/h, no condensation		
Relative humidity, tested in accordance with IEC 60068-2-78, IEC 60068-2-30			
Operation	5 ... 85 % at 30 °C, no condensation		
Storage/transport	5 ... 95 % at 25/55 °C, no condensation		
Air pressure, in accordance with IEC 60068-2-13			
Operation	1080 to 795 hPa, corresponds to an elevation of -1000 to 2000 m		
Storage/transport	1080 to 660 hPa, corresponds to an elevation of -1000 to 3500 m		

Mechanical ambient conditions

Vibration, tested according to DIN IEC 60068-2-6	
Operation	5 ... 8.4 Hz: 3.5 mm
Storage/transport	8.4 Hz to 500 Hz: 9.8 m/s ²
Shock resistance, tested in accordance with IEC 60068-2-27, IEC 60068-2-29	
Operation	50 m/s ² , 30 ms; 150 m/s ² , 11 ms
Storage/transport	250 m/s ² , 6 ms

8.4.3 Shipbuilding

Ambient conditions for use of the devices in shipbuilding

The device is suitable for shipping and offshore applications. The installation and attachment conditions are the same as those for industrial applications.

See the shipbuilding approvals of the individual shipbuilding companies in the section "Certificates and approvals" to learn about the required ambient conditions.

NOTICE
Ambient conditions and installation guidelines
The permissible ambient conditions and installation guidelines can be found in the certificates of the individual shipbuilding companies.

8.4.4 Power supply 7" and 9" device

Maximum permitted current consumption at the USB ports

Auxiliary components		Maximum permitted power consumption	Max. total power
		+5 V	
USB device 3.0	High current	900 mA	6 W (for all USB devices)
	Low current	100 mA	
USB Device 2.0	High current	500 mA	

Typical power consumption

	Power consumption (at a rated voltage of 24 V)	
	7"	9"
Basic device with Intel Celeron N2807	18 W	21 W
Basic device with Intel Celeron N2930	18 W	21 W
SSD	2 W	2 W
Expansion USB, max.	6 W	6 W

DC power supply

Input voltage	24 VDC (19.2 to 28.8 VDC)
Power consumption ¹	Max. 32 W
Power failure buffering	Hold-up time > 15 ms (DC_FAIL becomes active after > 5 ms)
Maximum continuous output power ¹	30 W

¹ The power specifications apply to the power supply component not to the device.

Note

Differences in power supply performance

A power supply with a maximum continuous output power of 27 W or 30 W can be installed on the 7" and 9" devices. However, these differences in performance have no influence on the other properties of the device.

Note

Inrush current

The inrush current of the device at an input voltage of 24 V amounts to at least 2 A for a period of 25 ms.

The peak value of the inrush current depends on the input voltage and the impedance of the 24 V source; peak currents in excess of 2.0 A are possible. This will not have a negative impact on device functionality.

8.4.5 Power supply 12", 15" and 19" device

Maximum permitted current consumption at the USB ports

Auxiliary components		Maximum permitted power consumption	Max. total power
		+5 V	
USB device 3.0	High current	900 mA	6 W (for all USB devices)
	Low current	100 mA	
USB Device 2.0	High current	500 mA	

Typical power consumption

	Power consumption (at a rated voltage of 24 V)		
	12"	15"	19"
Basic device with Intel Celeron N2807	24 W	36 W	36 W
Basic device with Intel Celeron N2930	24 W	36 W	36 W
SSD	2 W	2 W	2 W
Maximum USB extension	Max. 6 W	Max. 6 W	Max. 6 W
USB port, front	-	Max. 2.5 W	Max. 2.5 W

DC power supply

Input voltage	24 VDC (19.2 to 28.8 VDC)
Power consumption ¹	Max. 72 W
Power failure buffering	Hold-up time > 15 ms (DC_FAIL becomes active after > 5 ms)
Maximum continuous output power ¹	80 W

¹ The power specifications apply to the power supply component, not to the device.

Note

Differences in power supply performance

A power supply with a maximum continuous output power of 60 W or 80 W can be installed on the 12", 15" and 19" devices. However, these differences in performance have no influence on the other properties of the device.

Note

Inrush current

The device needs an inrush current of at least 4.5 A for 25 ms.

The peak value of the inrush current depends on the input voltage and the impedance of the 24 V source; peak currents in excess of 4.5 A are possible. This will not have a negative impact on device functionality.

8.4.6 Delivery state of the pre-installed software

8.4.6.1 Boot mode

Note

Setting Boot mode

We recommend that you restore the target system in the Boot mode that was set in the delivery state.

- Windows 10: UEFI Mode (UEFI = Unified Extensible Firmware Interface)
 - Windows 7: MBR Mode (MBR = Master boot record)
 - Windows Embedded Standard 7E: MBR Mode
 - Windows Embedded Standard 7P: MBR Mode
-

8.4.6.2 Partitions in Windows Embedded Standard 7

Partitioning of the SIMATIC IPC CFast card

The SIMATIC IPC CFast card for Windows Embedded Standard 7 comes configured with the following default partitions:

Partition	Name	Size of the card		File system
		8 GB	16 GB	
First	SYSTEM	7 GB	12 GB	NTFS (compressed)
Second	DATA	Remainder	Remainder	NTFS (compressed)

* Due to partitioning/formatting, the actual CFast capacity does not correspond to the memory size specified on the SIMATIC IPC CFast card.

Partitioning the hard disk or the SSD drive

The following partitions are configured in the delivery state of the data storage medium with Windows Embedded Standard 7:

Partition	Name	Size of data medium		File system
		>64 GB	>100 GB	
Primary	System	50 GB	100 GB	NTFS not compressed
Second	Data	Remainder	Remainder	NTFS not compressed

8.4.6.3 Partitions under Windows 7 x64/x86 and Windows 10

Partitioning the hard disk or the SSD drive

For the operating system **Windows 7 x64/x86 (boots in Legacy mode (MBR data storage medium))**, the following partitions are set up on the SSD in the delivery date:

Partition	Name	Size of data storage medium		File system
		> 60 GB	> 100 GB	
First	SYSTEM	60 GB	100 GB	NTFS (not compressed)
Second	DATA	Remainder	Remainder	NTFS (not compressed)

For the **Windows 10 operating system (boots in UEFI mode (GPT data storage medium))**, the following partitions are set up in the delivery date:

Partition	Name	Size of data storage medium		File system
		> 60 GB	> 100 GB	
First	SYSTEM	60 GB	100 GB	NTFS (not compressed)
Second	DATA	Remainder	Remainder	NTFS (not compressed)

8.5 Hardware description

8.5.1 Technical features of the motherboard

Component / port	Description	Parameters
Chipset	integrated in CPU	
BIOS	Core, Video, ACPI	
CPU	Intel Celeron N2930 / N2807	
Memory	DDR3L SODIMM	2 GB, 4 GB and 8 GB
Graphics	Integrated graphics	up to 512 MB graphics memory taken dynamically from RAM

8.5.2 External interfaces

8.5.2.1 Overview of interfaces

Interface	Position	Description	
COM	external	9-pin D-sub, optionally: <ul style="list-style-type: none"> • RS232 • RS485/RS422 	configurable in BIOS Setup
CFast	external	CFast card	
USB ¹	external	For 7" and 9" devices	1 × USB 3.0 2 × USB 2.0
		For 12", 15", and 19" devices	1 × USB 3.0 3 × USB 2.0
	Front	For 15" and 19" devices	USB 1.1/2.0
Ethernet	external	2 x RJ45	10/100/1000 Mbps
DisplayPort	External	DPP	

¹ Only two of these USB ports may be operated simultaneously in high current mode, max. 6 W.

8.5.2.2 Serial interface

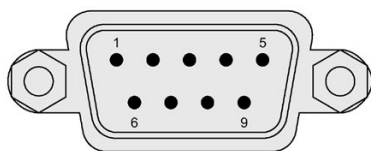

RS232
RS422
RS485

RS-232 assignment

Pin	Short description	Meaning
1	DCD	Data carrier detect (I)
2	RxD	Received data (I)
3	TxD	Transmitted data (O)
4	DTR	Data terminal ready (O)
5	M	Ground
6	DSR	Data set ready (I)
7	RTS	Request to send (O)
8	CTS	Clear to send (I)
9	RI	Incoming call (I)

Pin assignment RS422

Pin	Short description	Meaning
1	TX-	Transmit data - (O) for full-duplex mode
2	TX+	Transmit data + (O) for full-duplex mode
3	RX+	Receive data + (I) for full-duplex mode
4	RX-	Receive data - (I) for full-duplex mode
5	M	Signal ground
6	nc	
7	nc	
8	nc	
9	nc	

Pin assignment RS485

Pin	Short description	Meaning
1	Data-	Transmit / receive data - (I/O) for half-duplex mode
2	Data+	Transmit / receive data+ (I/O) for half-duplex mode
3	nc	
4	nc	
5	M	Signal ground
6	nc	
7	nc	
8	nc	
9	nc	

8.5.2.3 CFast

Pin	Short name	Meaning
S1	SGND	Signal GND (ground for signal integrity)
S2	A+	SATA differential
S3	A-	SATA differential
S4	SGND	Signal GND (ground for signal integrity)
S5	B-	SATA differential
S6	B+	SATA differential
S7	SGND	Signal GND (ground for signal integrity)
PC1	CDI	Card Detect In
PC2	GND	Device GND
PC3	TBD	TBD (not connected)
PC4	TBD	TBD (not connected)
PC5	TBD	TBD (not connected)
PC6	TBD	TBD (not connected)
PC7	GND	Device GND
PC8	LED1	LED Output (not connected)
PC9	LED2	LED Output (not connected)
PC10	IO1	Reserved Input/Output (not connected)
PC11	IO2	Reserved Input/Output (not connected)
PC12	IO3	Reserved Input/Output (not connected)
PC13	PWR	Device Power (3.3V)
PC14	PWR	Device Power (3.3V)
PC15	GND	Device GND
PC16	GND	Device GND
PC17	CDO	Card Detect Out

8.5.2.4 USB 2.0 port

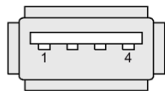

Pin	Short description	Meaning
1	USB_P5V_fused (O)	+5 V, fused
2	USB_D0M (I/O)	Data-
3	USB_D0P (I/O)	Data+
4	USB_GND	GND

8.5.2.5 USB 3.0 port

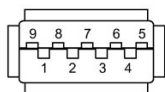

Pin	Short name	Meaning	Input / output
1	VBUS	+ 5 V (fused)	Output
2	D-	Data channel USB2	Input / output
3	D+	Data channel USB2	Input / output
4	GND	Ground	-
5	RX-	Data channel USB3	Input
6	RX+	Data channel USB3	Input
7	GND	Ground	-
8	TX-	Data channel USB3	Output
9	TX+	Data channel USB3	Output

8.5.2.6 Ethernet port

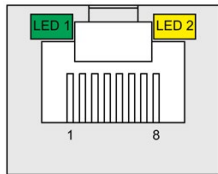

Pin	Short description	Meaning
1	BI_DA+	Bidirectional data A+, input/output
2	BI_DA-	Bidirectional data A-, input/output
3	BI_DB+	Bidirectional data B+, input/output
4	BI_DC+	Bidirectional data C+, input/output
5	BI_DC-	Bidirectional data C-, input/output
6	BI_DB-	Bidirectional data B-, input/output
7	BI_DD+	Bidirectional data D+, input/output
8	BI_DD-	Bidirectional data D-, input/output

LED	Short description	Meaning
1	LED 1	Off: 10 Mbps Lit green: 100 Mbps Lit orange: 1000 Mbps
2	LED 2	Lit orange: Connection established Flashes: Activity

8.5.2.7 DisplayPort

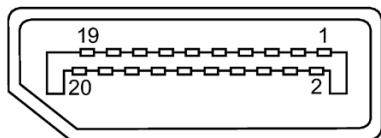

Pin	Short name	Meaning	Input / output
1	ML_Lane0+	DP data 0+	Output
2	GND	Ground	-
3	ML_Lane0-	DP data 0-	Output
4	ML_Lane1+	DP data 1+	Output
5	GND	Ground	-
6	ML_Lane1-	DP data 1-	Output
7	ML_Lane2+	DP data 2+	Output
8	GND	Ground	-
9	ML_Lane2-	DP data 2-	Output
10	ML_Lane3+	DP data 3+	Output
11	GND	Ground	-
12	ML_Lane3-	DP data 3-	Output
13	CONFIG1 CAD	Cable Adapter Detect	Input
14	CONFIG2	Ground (PullDown)	-
15	AUX_CH+	Auxiliary channel+	Bidirectional
16	GND	Ground	-
17	AUX_CH-	Auxiliary channel-	Bidirectional
18	HPD	Hot Plug Detect	Input
19	GND	Ground	-
20	DP_PWR	+3.3V (fused)	Output

8.5.3 System resources

8.5.3.1 Currently allocated system resources

All system resources (hardware addresses, memory utilization, interrupt assignment, DMA channels) are assigned dynamically by the Windows operating system, depending on the hardware equipment, drivers and connected external devices. You can view the current allocation of system resources or possible conflicts in the Control Panel.

Procedure

To view the system resources, proceed as follows:

1. In the Windows Start menu, select "Start -> Run".
2. Enter "msinfo32" in the command prompt and confirm your entry with "OK".

8.5.3.2 System resources used by the BIOS/DOS

The following tables and pictures describe the system resources for the factory state of the device.

Interrupt channels

The interrupts are assigned to devices by BIOS. An exclusive non-shared interrupt for Windows Embedded Standard 7 and Windows 7 is available for the primary Ethernet interface.

This means that applications or realtime operating system expansions can operate these devices exclusively and with high-performance without having to share the interrupt with other devices.

The following table shows the interrupt sharing in APIC mode:

Interrupt		Interrupt type
IRQ0	System Timer / HPET	ISA exclusive
IRQ1	PS/2 keyboard controller emulation	ISA exclusive
IRQ2	Interrupt controller 2	ISA exclusive
IRQ3	COM2	
IRQ4	COM1	
IRQ5	Free	
IRQ6	Reserved	
IRQ7	Free	
IRQ8	Realtime clock	ISA exclusive
IRQ9	ACPI-SCI (system control interrupt)	
IRQ10		ISA exclusive
IRQ11	Free	
IRQ12	PS/2 mouse controller emulation	ISA exclusive

Interrupt		Interrupt type
IRQ13	Free	ISA exclusive
IRQ14		ISA exclusive
IRQ15		ISA exclusive
IRQ16	PCIe Bridge 1/2/3/4 Graphics controller SMBus port PCI Standard RAM controller	PCI shared
IRQ17	LAN1 Gigabit Network Controller	PCI exclusive
IRQ18	LAN2 Gigabit Network Controller	PCI exclusive
IRQ19	PCI Express Port 4	PCI exclusive
IRQ20	USB EHCI controller USB XHCI controller	PCI shared
IRQ21	Trusted Execution Engine	PCI exclusive
IRQ22	SATA AHCI controller	PCI exclusive
IRQ23	HD audio controller	PCI exclusive

8.5.4 Input/output address areas

8.5.4.1 Overview of the internal module registers

The following addresses are used for the internal registers:

Addresses	Input/output unit
I/O 062h	Watchdog enable register / 066h select register (Page 122)
I/O 066h	Watchdog trigger register (read only, address 066h) (Page 123)
I/O 404Dh	Battery status register (read-only) (Page 123)

8.5.4.2 Watchdog enable register / 066h select register (read/write, address 062h)

Meaning of the bits

Watchdog enable register / 066h select register (r/w address 062h)									
Bit								Meaning of the bits	
7	6	5	4	3	2	1	0		
								Watchdog enable bit (WDE)	
							0	Watchdog circuit disabled	
							1	Watchdog circuit enabled	
								Watchdog Mode	
							0	Standard	
							1	Macro	
								066h select register selection	
							0	Reserved	
							1		
								Scaler watchdog time (Normal/Macro)	
		0	0	0				94 ms / 2 s (default)	
		0	0	1				210 ms / 4 s	
		0	1	0				340 ms / 6 s	
		0	1	1				460 ms / 8 s	
		1	0	0				590 ms / 16 s	
		1	0	1				710 ms / 32 s	
		1	1	0				840 ms / 48 s	
		1	1	1				960 ms / 64 s	

Watchdog enable register / 066h select register (r/w address 062h)								
Trigger red Watchdog LED								
	0							Red LED (WD) off
	1							Red LED (WD) on
Watchdog error / Display and reset								
0								WD inactive
1								WD triggered Reset LED after watchdog alarm (Bit 7 = write 1)

8.5.4.3 Watchdog trigger register (read only, address 066h)

Watchdog trigger register

The watchdog is triggered by a read action (address 066h) by this register. The result of the read access can be disregarded (i.e., dummy read).

8.5.4.4 Battery status register (read-only, address 50Ch)

The status of the CMOS battery is monitored; the status (two-tier) can be read from the battery status register.

Meaning of the bits

Battery status register (read-only, address 404Dh)								
Bit								Meaning
7	6	5	4	3	2	1	0	
0	0							CMOS battery capacity is still sufficient.
0	1							CMOS battery capacity is exhausted (remaining capacity is sufficient for approx. one month)
1	1							CMOS battery is empty

8.5.4.5 NVRAM address register

NVRAM occupies a 512 KB memory address area that can be read via PCI registers.

Meaning of the bits

NVRAM address register		
PCI register address: NVRAM base address register	PCI register content: NVRAM memory address (default)	Length of the memory area
9060 0000h	Address is assigned dynamically (depending on device configuration)	80000 h

8.6 BIOS description

8.6.1 Overview

Parameterize your device in the BIOS Setup.

BIOS Setup program

The BIOS Setup program, or BIOS Setup for short, is located, together with the setup parameters, in a FLASH block on the motherboard.

Change the setup parameters of the device in the BIOS Setup, e.g. system time or boot sequence.

Changing the device configuration

Your device configuration is preset for operating with the included software. You should only change the default setup parameters if technical modifications to your device require different parameters.

NOTICE

Malfunctions can occur with running software CPU

If a BIOS update of the PC is performed while SIMATIC software controller, a SIMATIC WinAC for example, is running, the software CPU can malfunction, resulting in communication interruptions or failures, for example. Other actions that put a heavy load on the PC hardware, for example, running hardware tests such as benchmarks, can result in malfunctions of the software CPU.

Do not run a BIOS update or other actions that would put a heavy load on the hardware during operation of a software CPU.

Switch the software CPU to "STOP" before you run a BIOS update or perform other critical actions.

Note

Documentation

BIOS Setup is described for all devices and device configurations. Some BIOS submenus or Setup parameters may not be included, depending on your order. The interface of your BIOS Setup can deviate from the figures in this document.

You can find a detailed description of the BIOS on the Support website under Entry ID 92189178 (<http://support.automation.siemens.com/WW/view/en/92189178>).

8.6.2 Opening the BIOS selection menu

Procedure

1. Reset the device (warm or cold restart).

Depending on the device version, the default settings can differ from the figures shown.

The following message appears briefly on the display at the end of the self-test:

Press ESC for boot options

2. Press <ESC> to open the BIOS selection menu:



The following keys are available in the BIOS selection menu:

Buttons	Function
Continue	Exit selection menu, continue start sequence
Boot Manager	Specify the boot media from which to boot: <ul style="list-style-type: none"> • Hard disk drive • CD-ROM drive • USB drive (USB boot = enabled)
Device Management	Start device manager for UEFI boot media
Boot From File	Boot Maintenance Manager: <ul style="list-style-type: none"> • Boot Options: Set boot order • Driver Options: Configure drivers • Console Options: Configure connected input device • Boot from File: Start from an ".EFI" file • Reset System: Restoring factory settings
Secure Boot Option ¹	Configuration settings to start the device in Secure Boot mode. The only software modules loaded are those that are known to be safe for the BIOS or the operating system.

Buttons	Function
SCU	Start BIOS Setup via Setup Configuration Utility
BIOS Update	Update BIOS from USB memory stick

¹ Available as of Windows 8 or later

8.6.3 Structure of the BIOS Setup menu

The individual setup parameters are distributed between different menus and submenus. Not all menus are included in each supplied device configuration. The following table shows the menus.

Menu	Meaning
Main	Display system information, for example, BIOS version, processor and memory
Advanced	Configure hardware using different submenus
Security	Security functions, e.g., setting a password
Power	Specify power management of CPU and the device
Boot	Determine boot options, e.g., boot order
Exit	Save and exit (see Exit menu)

The menus always have the same structure. The figure below shows an example for the "Main" menu. Device-specific information is shown blurred.

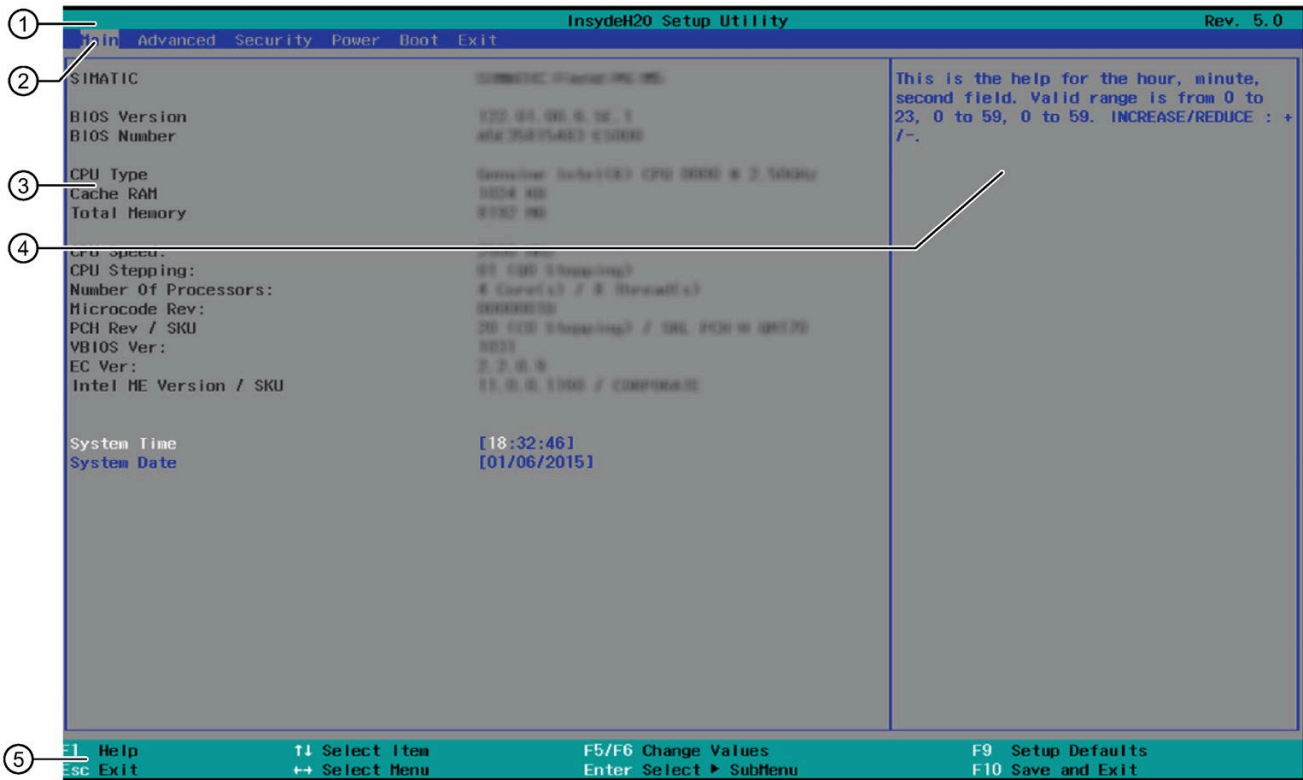

- ① Header The current version of the selected BIOS Setup is displayed in the header.
- ② Menu bar Switch between the various menus "Main", "Advanced", etc. in the menu bar at the top.
- ③ Settings, submenus and device-specific information Information about your device is displayed in the center left-hand area; here you can edit settings which are partly in submenus.

- | | |
|------------------|--|
| ④ Help area | Short help texts on the currently selected setup parameters are displayed in the center right-hand area. |
| ⑤ Key assignment | The key assignment for navigation in the BIOS Setup is found in the footer. |

8.6.4 Exit menu

You always exit BIOS Setup in this menu.

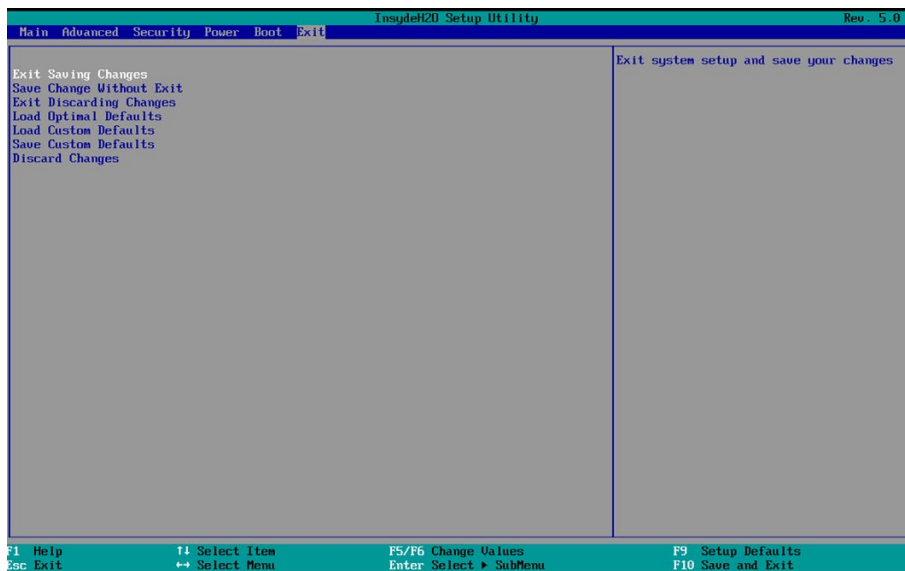

Exit Saving Changes	All changes are saved and the system is restarted with the new Setup parameters.
Save Change Without Exit	All changes are saved
Exit Discarding Changes	All changes are discarded and the system is restarted with the old Setup parameters.
Load Optimal Defaults	All setup parameters are reset to the safe default values. Notice: The existing Setup parameters are overwritten by this.
Load Custom Defaults	The profile must be loaded with the custom Setup parameters. Requirement: The parameters are saved prior to this with "Save Custom Defaults". Notice: All existing Setup parameters are overwritten during loading. <ul style="list-style-type: none"> • Write down the BIOS Setup settings beforehand • Save the BIOS Setup settings as user-specific profile.
Save Custom Defaults	The currently configured Setup parameters are saved as a custom profile (see also "Load Custom Defaults").
Discard Changes	All changes are discarded.

8.6.5 Default BIOS Setup entries

Documenting your device configuration

If you have changed any default settings in Setup, you can enter them in the following table. You can then refer to these entries for any future hardware modifications.

Note

Print out the table below and keep the pages in a safe place once you made your entries.

BIOS Setup default settings

System parameters	Defaults	Custom entries
Main		
System Time	hh:mm:ss	
System Date	MM/DD/YYYY	
Boot configuration		
Numlock	On	
POST errors	All without keyboard	
Peripheral Configuration		
Internal COM 1	Enabled	
Base I/O address	3F8	
Interrupt	IRQ4	
Transceiver Mode	RS232	
Internal COM2 ¹	Enabled	
Base I/O address ¹	2F8	
Interrupt ¹	IRQ3	
Transceiver Mode ¹	RS232	
On-board Ethernet 1	Enabled	
Ethernet 1 Address	00:1B:1B:41:42:7B (example)	
On-board Ethernet 2	Enabled	
Ethernet 2 Address	00:1B:1B:0A:85:10 (example)	

¹⁾ Only for devices with COM2

USB Configuration		
USB BIOS Support	Enabled	
xHCI Mode	Disabled	
USB Per-Port Control	Enabled	
USB Port#	Enabled	

Miscellaneous Configuration		
HPET - HPET support	Enabled	
PCI MMIO Size	1 GB	

Video Configuration		
IGD Boot Type	VBIOS default	

SATA Configuration		
SATA Controller	Enabled	
Chipset SATA Mode	AHCI	

Security		
Supervisor Password	Not installed	
User password	Not installed	
Power on password	Disabled	
User Access Level	Full	
Current TPM Device	<TPM 2.0>	
TPM State	Disabled	
TPM Availability	<Available>	
TPM Operation	<No Operation>	
Clear TPM	<input type="checkbox"/>	

Power		
Wake on LAN	Enabled	
USB Port1 Wake Capability	Disabled	
USB Port2 Wake Capability	Disabled	
USB Port3/4 Wake Capability	Disabled	

Wake on Touch: The Wake on Touch function can be activated via the operating system. Hibernate is not enabled by default in the operating system.

To enable Hibernate under Windows 10, follow these steps:

1. Right-click on the Windows button.
2. Click on "Command Prompt (Administrator)".
3. Enter "powercfg -h on" and then press ENTER.
4. Close the command prompt.

The IPC can now be set to "Hibernate" using the Start menu.

The IPC is powered up again when you touch the touch screen.

Advanced CPU Control		
Use XD Capability	Enable	
VTX-2	Enabled	
AESNI Feature	Enabled	
P-states (ACTUAL)	Enabled	
Turbo Mode	Auto	
C-states	Enabled	
Max C-States	C7	

Boot		
Boot Type	Dual Boot Type	
Quick Boot	Enabled	
Quiet Boot	Enabled	
Network Stack	Disabled	
Add Boot Options	Auto	
USB Boot	Enabled	
EFI Device First	Disabled	
Network Stack	Disabled	
PXE Boot on Demand	Disabled	
PXE Boot Capability	Disabled	
Timeout	0	

Legacy / Boot Device Priority		
Normal Boot Menu	Standard	

8.6.6 BIOS update

Check regularly if updates are available for download to your device.

Additional information can be found on the Internet at the following address: After-sales information system for SIMATIC PC/PG (<http://www.siemens.com/asis>).

Noting down and restoring BIOS Setup settings

NOTICE

Irretrievable loss of data

All BIOS Setup settings are deleted after the BIOS update. This can put the system in an undefined state. This may damage the device and the plant.

1. Print out the table in the next section "General BIOS Setup settings".
2. Enter your specific BIOS Setup setting in this table before you run a BIOS update.
3. Start BIOS Setup after the BIOS update.
4. Load the BIOS Setup default settings with <F9> "Setup Defaults". Or use the BIOS Setup command "Load Optimal Defaults" in the "Exit" menu.
5. Make your own Setup settings based on the table you have printed out.
6. Save the BIOS Setup settings with <F10> "Save and Exit".

Performing a BIOS update

NOTICE

Damage to the device

If you switch off the device during the update, the BIOS will be incomplete and corrupt. This may result in malfunctions.

Leave the device switched on during the update.

If you have purchased a new BIOS update for your device, follow these steps to install the update:

1. Connect the device to the power supply.
2. Copy the update to a USB memory stick.
3. Reset the device (warm or cold restart).

The following message appears briefly on the display at the end of the self-test:

`Press ESC for boot options`

4. Press <ESC> to open the BIOS selection menu.
5. Click the "BIOS Update" button.
6. Follow the instructions on the screen.

Reboots

There may be several reboots after a BIOS update. These reboots are initiated by the Trusted Execution Engine (TXE). The reboots are required by the ME to adapt itself to the changes of the BIOS update.

8.6.7 Alarm, error and system messages

During startup (the boot process), the BIOS first performs a **Power On Self Test (POST)** and checks whether certain functional units of the PC are operating error-free. The boot sequence is immediately interrupted if critical errors occur.

BIOS initializes and tests further functional units if the POST does not return any errors. In this startup phase, the graphics controller is initialized and any error messages are output to the screen.

The error messages output by system BIOS are listed below. For information on error messages output by the operating system or application programs, refer to the corresponding manuals.

On-screen error messages

On-screen error message	Meaning / tip
Operating system not found	Possible causes: <ul style="list-style-type: none"> • No operating system installed • Incorrect active boot partition • Wrong boot drive settings in SETUP
Keyboard controller error	Controller error. Contact your technical support team.
SMART failure detected on HDD	Hard disk reports pending failure through S.M.A.R.T.
CMOS battery failed	CMOS battery is not connected.
CMOS battery weak	CMOS battery is weak
Real-time clock has lost power	The CMOS clock was operated without battery or with a battery that was too weak, during battery change, for example. Check the CMOS clock.
Keyboard error	<ul style="list-style-type: none"> • Field PG: Internal keyboard defective and no external keyboard connected • Other devices: Keyboard defective or not connected
PLD configuration failed	Programming of the PLC on the motherboard has failed.

Technical Support

A.1 Service and support

You can find additional information and support for the products described on the Internet at the following addresses:

- Technical support (<https://support.industry.siemens.com/cs/ww/en/>)
- Support request form (<http://www.siemens.com/automation/support-request>)
- After Sales Information System SIMATIC IPC/PG (<http://www.siemens.com/asis>)
- SIMATIC Documentation Collection (<http://www.siemens.com/simatic-tech-doku-portal>)
- Your local representative (<http://www.automation.siemens.com/mcms/aspa-db/en/Pages/default.aspx>)
- Training center (<http://sitrain.automation.siemens.com/sitrainworld/?AppLang=en>)
- Industry Mall (<https://mall.industry.siemens.com>)

When contacting your local representative or Technical Support, please have the following information at hand:

- MLFB of the device
- BIOS version for industrial PC or image version of the device
- Other installed hardware
- Other installed software

Current documentation

Always use the current documentation available for your product. You can find the latest edition of this manual and other important documents by entering the article number of your device on the Internet. If necessary, filter the comments for the entry type "Manual".

Tools & downloads

Please check regularly if updates and hotfixes are available for download to your device. The download area is available on the Internet at the following link:

After Sales Information System SIMATIC IPC/PG (<http://www.siemens.com/asis>)

A.2 Problem solving

This section provides you with tips on how to locate and/or troubleshoot problems which occur.

Problem	Possible cause	Possible remedy
The device is not operational	No power supply	<ul style="list-style-type: none"> • Check the power supply, the power cord and the power plug. • Check if the On/Off switch is in the correct position.
	Device is being operated outside the specified ambient conditions	<ul style="list-style-type: none"> • Check the ambient conditions. • After transport in cold weather, wait approximately 12 hours before switching on the device.
The monitor remains dark	The brightness button has been set to dark	Increase brightness using the brightness button. For detailed information, refer to the monitor operating instructions.
	Power cord is not connected	<ul style="list-style-type: none"> • Check whether the power cord has been properly connected to the monitor and to the system unit or to the grounded shockproof outlet. <p>If the monitor screen still remains dark after you have performed these checks and measures, contact your technical support team.</p>
The mouse pointer does not appear on the screen	The mouse driver is not loaded	Check whether the mouse driver is properly installed and available when you start the user program. Detailed information about the mouse driver is available in the corresponding documentation.
	Mouse not connected.	<ul style="list-style-type: none"> • Check whether the mouse cord is properly connected to the system unit. • If you use an adapter or expansion for the mouse cable, also check these connectors.
		If the mouse pointer still does not appear on the screen after you have performed these checks and actions, contact your technical support team.
Wrong time and/or date on the PC		<ol style="list-style-type: none"> 1. Open BIOS Setup. 2. Set the time or date.
Although the BIOS setting is OK, the time and data are still wrong.	The backup battery is dead.	Replace the backup battery.
USB device not responding.	The USB ports are not correctly supported.	<ul style="list-style-type: none"> • Turn on USB Legacy Support for mouse and keyboard. • For other devices, you need the USB device drivers for the required operating system.
"chkdsk" is not functioning	EFW (Enhanced Write Filter) has been activated. The "chkdsk" command is not supported if the EFW has been activated.	Deactivate the EFW or use an alternative method to "chkdsk".









Markings and symbols

B.1 Overview



The following tables show all the symbols which may be found on your SIMATIC industrial PC, SIMATIC industrial monitor or SIMATIC Field PG in addition to the symbols which are explained in the operating instructions.

The symbols on your device may vary in some details from the symbols shown in the following tables.

B.2 Safety

Symbol	Meaning	Symbol	Meaning
	Warning, observe the supplied documentation.		Lock is closed
	Attention, radio equipment		Lock is open
	Disconnect the power plug before opening		Opening for Kensington lock
	Attention ESD (Electrostatic sensitive device)		Warning of hot surface

B.3 Operator controls

Symbol	Meaning	Symbol	Meaning
	On/off switch, without electrical isolation		Eject CD/DVD
	On/off switch, without electrical isolation		

B.4 Safety-relevant symbols

General information

ATEX/IECEX – Additional Instructions for use in Gas Explosive Atmospheres (only valid for specific MLFBs - marked with IECEX/ATEX symbol on the nameplate of the device)

	II 3G	Ex nA IIC T4 Gc
	II 3D	Ex tc IIIC T70°C Dc

Approval Mark ATEX 15ATEX0119X and/or IECEX DEK 15.0080X











Ta: +0...+45 °C

IP65

	 230V MODULES		 INDOOR USE ONLY INDUSTRIAL USE ONLY	 24V MODULES	 CABLE SPEC.	 EMC
	 230V MODULES		 INDOOR USE ONLY INDUSTRIAL USE ONLY	 24V MODULES	 CABLE SPEC.	 EMC
ONLY EX MODULES	 U = 0V		 ZONE 2 INSIDE CABINET IP54 EN60079-15			

B.5 Certificates, approvals and markings

The following table shows symbols relating to certificates, approvals and markings which may be on the device. You can find more information in the operating instructions for your device:

Symbol	Meaning	Symbol	Meaning
	Approved for Australia and New Zealand		Marking for the Eurasian Customs Union
	Approved for China		Test mark of Factory Mutual Research
	CE markings for European countries		Marking of Federal Communications Commission for the USA
	EFUP (Environment Friendly Use Period) marking for China		Approved for Korea
	Test mark of the Underwriters Laboratories		Disposal information, observe the local regulations.

B.6 Interfaces

Symbol	Meaning	Symbol	Meaning
	Connection to the power supply		PS/2 mouse interface
	Protective conductor terminal		PS/2 keyboard-interface
	Connection for functional earthing (equipotential bonding line)		Multimedia Card Reader
DPP	DisplayPort interface		Smart Card Reader
	DVI-D interface		Line In
LAN	LAN interface, not approved for connecting WAN or telephone		Line Out
	Serial interface		Microphone input
	USB port		Universal Audio Jack
	USB 2.0 HiSpeed interface		Headphone output
	USB 3.0 super-speed port		
	USB 3.1 SuperSpeedPlus interface		

List of abbreviations

AC	Alternating current	Alternating current
ACPI	Advanced Configuration and Power Interface	
AHCI	Advanced Host Controller Interface	Standardized controller interface for SATA devices. This is supported in Microsoft Windows XP as of SP1 and IAA driver.
APIC	Advanced Programmable Interrupt Controller	
AT	Advanced Technology	
ATA	Advanced Technology Attachment	
AWG	American Wire Gauge	Unit of measurement for wire diameter. Used in North America and Canada.
BIOS	Basic Input Output System	
CAN	Controller Area Network	
CD-ROM	Compact Disc – Read Only Memory	
CE	Communauté Européenne	
CF	CompactFlash	
CMOS	Complementary Metal Oxide Semiconductors	
COA	Certificate of authentication	
COM	Communications Port	Term for the serial interface
CPU	Central Processing Unit	CPU
CSA	Canadian Standards Association	Canadian organization for tests and certifications according to national or binational standards
CTS	Clear To Send	Clear to send
DC	Direct Current	DC current
DCD	Data Carrier Detect	Data carrier signal detection
DMA	Direct Memory Access	
DOS	Disk Operating System	
DP	DisplayPort	
DQS	Deutsche Gesellschaft zur Zertifizierung von Qualitätsmanagement mBH	

DSR	Data Set Ready	Ready for operation
DTR	Data Terminal Ready	Data terminal is ready
ESD	Components sensitive to electrostatic charge	
EN	European standard	
EEPROM	Electrically Erasable Programmable Read-Only Memory	
ESD	Electrostatic Sensitive Device	Electrostatic Sensitive Devices
	Electrostatic discharge	Electrostatic discharge
EWF	Enhanced Write Filter	
FBWF	File Based Write Filter	
GND	Ground	Chassis ground
HD	Hard disk	Hard disk
HDD	Hard Disk Drive	HDD
HMI	Human Machine Interface	User interface
HORM	Hibernate Once - Resume Many	
HT	Hyper Threading	
I/O	Input/Output	Data input/output for computers
IDE	Integrated Device Electronics	
IEC	International Electrotechnical Commission	
IGD	Integrated Graphics Device	
IP	International Protection	Degree of protection
	in English-speaking countries: Ingress Protection	
IRQ	Interrupt Request	
ISA	Industry Standard Architecture	Bus for expansion modules
LAN	Local Area Network	Computer network that is limited to a local area.
LEDs	Light Emitting Diode	Light emitting diode
LPS	Limited Power Source	
MAC	Media access control	Media access control
MLFB	Machine-readable product designation	
MS	Microsoft	
MTBF	Mean Time Between Failures	
MUI	Multilanguage User Interface	Language localization in Windows
NTFS	New Technology File System	
NVRAM	Non Volatile Random Access Memory	Non-volatile data memory. Data memory is retained without external power supply.
ODD	Optical Disk Drive	

PC	Personal computer	
PCI	Peripheral Component Interconnect	High-speed expansion bus
PCIe	Peripheral Component Interconnect express	High-speed serial, differential full-duplex PTP interface with high data rate.
PG	Programming device	
POST	Power On Self Test	
PXE	Preboot Execution Environment	Software for running new PCs without hard disk data via the network
RAID	Redundant Array of Independent Disks	Redundant hard disk array
RAL	Restricted Access Location	
RAM	Random Access Memory	
RI	Ring Input	Incoming call
ROM	Read-Only Memory	
RS485	Reconciliation Sublayer 485	Bidirectional bus system
RTC	Real Time Clock	Real-time clock
RTS	Request to send	Request to send
RxD	Receive Data	Data transfer signal
SATA	Serial Advanced Technology Attachment	
SCU	Setup Configuration Utility	
SELV	Safety Extra Low Voltage	Safety extra low voltage
SMART	Self Monitoring Analysis and Reporting Technology	Hard disk error diagnostics program
SRAM	Static Random Access Memory	Static RAM
SSD	Solid State Drive	
TFT	Thin-Film-Transistor	
TxD	Transmit Data	Data transfer signal
UEFI	Unified Extensible Firmware Interface	
UL	Underwriters Laboratories Inc.	US organization for testing and certification according to national or binational standards.
USB	Universal Serial Bus	
VDE	Verband der Elektrotechnik, Elektronik und Informationstechnik e.V (Association for Electrical, Electronic and Information Technologies)	

VT	Virtualization Technology	Intel technology which provides a virtual, closed environment.
VT-d	Virtualization Technology for Directed I/O	Enables the direct assignment of a device (e.g. network adapter) to a virtual device.
WD	Watchdog	Program monitoring with error detection and alarming.

Glossary

AHCI mode

AHCI is a standardized method to address the SATA controller. AHCI describes a structure in the RAM, which contains a general area for control and status, as well as a command list.

APIC mode

Advanced peripheral interrupt controller. 24 interrupt lines are available.

Automation system

A programmable controller (PLC) of the SIMATIC S7 system consist of a central controller, one or several CPUs, and various I/O modules.

Backup

Duplicate of a program, data medium or database, used either for archiving purposes or for the protection of vital and non-replaceable data against loss when the working copy is corrupted. Certain applications automatically generate backup copies of data files, and manage both the current and the previous versions on the hard disk.

Baud

Physical unit for the step speed in signal transmission. Defines the number of transferred signal states per second. With only two states, one baud is equivalent to a transmission rate of 1 bps.

Cache

High-speed access buffer for interim storage (buffering) of requested data.

CE marking

Communauté Européene: The CE symbol confirms the conformity of the product with all applicable EC directives such as the EMC Directive.

CFast

The faster SATA protocol is used with the CFast standard for memory cards based on CompactFlash. The connectors on these cards are not compatible with a classic CompactFlash card.

Chipset

Located on the motherboard, connects the processor with the PCI or PCIe bus and the external interfaces.

Cold restart

A start sequence, starting when the computer is switched on. The system usually performs some basic hardware checks within the cold start sequence, and then loads the operating system from the hard disk to work memory -> boot

COM interface

The COM interface is a serial V.24 interface. The interface is suitable for asynchronous data transfer.

CompactFlash card

CompactFlash is a digital storage medium in card format and without moving parts. The CF card contains the non-volatile memory and the controller. The interface of the CF card corresponds with the IDE interface. CF cards can be operated without additional electronics on PCMCIA or IDE hard disk controllers using a plug and socket adapter. There are two design forms: CF-I (42.6 x 36.4 x 3.3 mm) and CF-II (42.8 x 36.4 x 5 mm).

Configuration files

These are files containing data which define the configuration after restart. Examples of such files are CONFIG.SYS, AUTOEXEC.BAT and the registry files .

Configuration software

The configuration software updates the device configuration when new modules are installed . This is done either by copying the configuration files supplied with the module or by manual configuration using the configuration utility.

Controller

Integrated hardware and software controllers that control the functions of certain internal or peripheral devices (for example, the keyboard controller).

Device configuration

The configuration of a PC or programming device contains information on hardware and device options, such as memory configuration, drive types, monitor, network address, etc. The data are stored in a configuration file and enable the operating system to load the correct device drivers and configure the correct device parameters. . If changes are made to the hardware configuration, the user can change entries in the configuration file using the SETUP program. .

Drivers

Program parts of the operating system. They adapt user program data to the specific formats required by I/O devices such as hard disk, printers, and monitors.

EMC directive

Directive concerning **Electromagnetic Compatibility**. Compliance is confirmed by the CE symbol and the EC certificate of conformity.

Energy management

The energy management functions of a modern PC allow individual control over the current consumption of vital computer components (e.g. of the monitor, hard disk and CPU), by restricting their activity based on the current system or component load. Energy management is of particular importance for mobile PCs.

Energy options

The energy options can be used to reduce energy consumption of the computer, while keeping it ready for immediate use. This can be configured in Windows by selecting Settings > Control Panel > Energy options.

Enhanced Write Filter

Configurable write filter that allows you to, for example, boot Windows Embedded Standard from write-protected media (e.g., CD-ROM), set write protection for individual partitions, and adapt the file system performance to user requirements (when using memory cards, for example).

ESD Guideline

Guideline for using electrostatic sensitive components.

Ethernet

Local network (bus structure) for text and data communication with a transfer rate of 10/100/1000 Mbps.

Execute Disable Capability

Hardware implementation that prevents mutual memory accesses by programs and applications. It is only effective when all relevant system components, such as processors, operating systems and applications are supported.

Extensible Firmware Interface

Refers to the central interface between the firmware, the individual components of a computer and the operating system. EFI is located logically beneath the operating system and represents the successor to PC BIOS, focusing on 64-bit systems.

File Based Write Filter

Configurable write filter to protect individual files from write access.

Formatting

Basic partitioning of memory space on a magnetic data medium into tracks and segments. Formatting deletes all data on a data medium. All data media must be formatted prior to their first use.

HORM

Hibernate once, resume many is a method for fast booting from a single Hibernate file that only needs to be created once. HORM ensures restoration of a uniform, saved system state when booting. This minimizes write access, for example to a memory card, when you start up and shut down Windows Embedded Standard 7.

Hub

A term in network technology. In a network, a device joining communication lines at a central location, providing a common connection to all devices on the network.

Hyper Threading

HT technology (multi-threading) enables the parallel computing of processes. HT is only effective when all relevant system components, such as processors, operating systems and applications are supported.

IGD

Integrated Graphics Device. Graphics interface integrated in the chipset.

Image

This refers to the image, for example, of hard disk partitions saved to a file in order to restore them when necessary.

Intel Active Management Technology

This technology permits diagnostics, management and remote control of PCs. It is only effective when all relevant system components, such as processors, operating systems and applications are supported.

Intel VT

The Intel Virtualization Technology (IVT) is the implementation of a secure closed environment for applications. Special (visualization) software on a VT-capable processor is required for its use.

Interface

- Physical interconnection (cable) of hardware elements such as PLCs, PCs, programming devices, printers or monitors.
- Interface for interactive software applications.

LAN

Local Area Network: LAN is a local network that consists of a group of computers and other devices that are distributed across a relatively restricted range and are linked with communication cables. The devices connected to a LAN are called nodes. The purpose of networks is the mutual use of files, printers or other resources.

Legacy Boot Device

Conventional drives can be used as USB devices.

License key

The license key represents the electronic license stamp of a license. Siemens AG issues a license key for each software that is protected by a license.

License key USB flash drive

The license key USB flash drive contains the authorizations or license keys required to enable protected SIMATIC software.

Low-voltage directive

EC Product Safety Directive relating to the safety of products which are operated on low voltage (50 V AC to 1000 V AC, 70 V DC to 1500 V DC) and not specified in other directives. Compliance is confirmed by the CE symbol and the EC certificate of conformity.

Module

Modules are plug-in units for PLCs, programming devices or PCs. They are available as local modules, expansion modules, interfaces or mass storage (Mass storage module).

Motherboard

The motherboard is the core of the computer. Here, data are processed and stored, and interfaces and device I/Os are controlled and managed.

Operating system

Generic term which describes all functions for controlling and monitoring user program execution, distribution of system resources to the user programs and the operating mode in cooperation with the hardware (for example, Windows 7 Ultimate).

Pixel

The pixel represents the smallest element that can be reproduced on-screen or on a printer.

Plug&Play

Generally, a reference to the ability of a computer to automatically configure the system for communication with peripheral devices (for example monitors, modems or printers). The user can plug in a peripheral and "play" it at once without manually configuring the system. A Plug&Play PC requires both a BIOS that supports Plug&Play and a Plug&Play expansion card.

POST

Self-test performed by the BIOS after the computer is switched on. Performs a RAM test and a graphics controller test, for example. The system outputs audible signals (beep codes) if the BIOS detects any errors; the relevant message indicating cause of error is output on the screen.

Programmable controller

The programmable controllers of the SIMATIC S7 system consist of a central controller, one or more CPUs, and various other modules (e.g. I/O modules).

PXE server

A Preboot Execution Environment server is part of a network environment and can provide software to connected computers even before they boot. This can involve operating system installations or servicing tools, for example.

RAL

Restricted Access Location: Installation of the device in a production facility with restricted access, for example, a locked control cabinet.

Recovery function of the USB stick

Contains the tools for configuring hard disks and the Windows operating system.

Reset

Hardware reset: Reset/restart of the PC using a button/switch.

Restart

Warm restart of a computer without switching the power off (Ctrl + Alt + Del)

Restore function of the USB stick

The Restore function is used to restore the system partition or the entire hard disk to factory state in the event of a fault. The USB stick contains all the necessary image files and is bootable.

ROM

Read-Only Memory ROM is a read-only memory in which every memory location can be addressed individually. The programs or data are permanently stored and are not lost in the event of a power failure.

S.M.A.R.T

Self-Monitoring, Analysis and Reporting Technology (SMART or S.M.A.R.T.) is an industry standard integrated in storage media. It makes for permanent monitoring of important parameters and early detection of imminent problems.

SATA

Serial ATA Interface for hard disk drives and optical drives with serial data transmission rates of up to 300 Mbps.

SETUP (BIOS Setup)

A program in which information about the device configuration (that is the configuration of the hardware on the PC/PG) is defined. The device configuration of the PC/PG is preset with defaults. Changes must therefore be entered in the SETUP if a memory expansion, new modules or a new drive are added to the hardware configuration.

SSD (Solid State Drive)

A Solid State Drive is a drive that can be installed like any other drive; it does not contain a rotating disk or other moving parts because only semiconductor memory chips of similar capacity will be used. This design makes SSDs more rugged, provides shorter access times, low energy consumption and rapid data transfer.

STEP 7

Programming software for the creation of user programs for SIMATIC S7 controllers.

Troubleshooting

Error cause, cause analysis, remedy

Trusted Execution Technology

Hardware implementation that allows secured execution of programs and applications. It is only effective when all relevant system components, such as processors, operating systems and applications are supported.

Wake on LAN

Wake on Local area network. This function allows the PC to be started via the LAN interface.

Warm restart

The restart of a computer after a program was aborted. The operating system is loaded and restarted again. The CTRL+ ALT+ DEL hotkey can be used to initiate a warm restart.

Index

A

Approval
 Marine, 91
Australia, 91

B

Backup battery, 66
Battery monitoring, 66
BIOS Setup, 125
 Defaults, 131
 Exit menu, 130
 Menu layout, 128
Boot sequence, 135
Bottom view, 14

C

CAN
 Base address register, 123
CE marking, 85
Certificates, 85
 Certifications and approvals, 85
CFast card
 Interface, 116
chkdsk, 138
Cleaning Agents, 79
COA label, 33, 34
Components sensitive to electrostatic charge, 93
Condensation, 32
Connecting
 Network, 57
 Peripherals, 49
 Protective conductor, 51
 Protective earth, 52
Connecting the protective earth, 52
Creating an image, 83

D

Data backup, 83
Data exchange, 57
DC power supply, 110, 111
Degree of protection, 37, 104

Device

 Closing, 74
 Opening, 73, 74
 Switching off, 62
Device configuration, 131
DiagBase software, 63
DiagMonitor
 Temperature monitoring, 64
DiagMonitor software, 63
Diagnostics, 63, 63
 DiagBase software, 63
 DiagMonitor software, 63
 Error Messages, 135
Directive
 ESD Directive, 93
Display, 28
 Size, 9
DisplayPort
 Interface, 119
Drive, 105

E

Earth connection, 70
Enable register
 Watchdog, 123
ESD, 93
ESD Directive, 93
Ethernet, 57, 114
EU Declaration of Conformity, 85
External interfaces, 114

F

FCC, 90
Fire protection covering, 39
Fire protection enclosure, 39
Front view, 12, 17

H

HMI device
 Mounting, 42

I

- Identification data, 33
- Industrial Ethernet, 57
- Installation guidelines, 39
- Installation information, 39
- Integration
 - Ethernet, 57
 - Industrial Ethernet, 57
 - PROFINET, 57
- Interface, 107
- Interfaces
 - CFast card, 116
 - DisplayPort, 119
 - USB 2.0, 117
 - USB 3.0, 117
- IT communication, 57

K

- KC Mark, 91
- Korea
 - KC Mark, 91
- Korean Certification, 91

L

- Labeling, 86
 - cULus HAZ. LOC., 86
- Limitation of liability, 78

M

- Marine approval, 91
- Marking
 - EU Declaration of Conformity, 85
- Memory medium, 105
- Messages
 - On the screen, 135
- Monitoring functions, 63
- Motherboard
 - External interfaces, 114
 - Technical features, 114
- Mounting
 - HMI device, 42
 - Mounting clip, 41
 - with latch fasteners, 43
- Mounting clip
 - Installing, 41

- Mounting cutout
 - Dimensions, 37
 - Preparing, 37
- Mounting positions, 35

N

- New Zealand, 91
- Note, 39
 - General Information, 27
 - Installation guidelines, 39
- NVRAM, 66

O

- On-screen error messages, 135
- Operation
 - Capacitive multi-touch screen, 70
 - Touch screen, 67, 69

P

- Package contents, 31
 - Checking, 31
- Packaging, 31
 - Checking, 31
 - Removing, 31
- Partitioning
 - CFast card, 112
 - SSD, 112
- Partitioning the hard disk, 113
- PE conductor, 70
- Pixel, 28
 - Defective pixel, 28
- Power supply
 - DC power supply, 110, 111
 - Power requirements of auxiliary components, 109, 111
- PROFINET, 57
- Protective conductor, 51
 - Connecting, 51
- Protective earth, 51
- Protective measure
 - Static electricity, 95

R

Radiation, 25
 High frequency radiation, 25
Rating plate, 33
Rear view, 14
Repairs, 77, 78

S

Safety information
 Storage, 32
 Transportation, 32
Safety instructions
 General, 23
Shipbuilding
 Assembly for shipbuilding, 109
Side view, 12, 17
SIMATIC NET, 57
SIMATIC S7, 57
 Integration, 57
SSD
 Partitioning, 112, 113
Startup, 135
Static electricity
 Protective measures, 95
Strain relief, 60
Switching off the device, 62
Switching on the device, 62
System resources, 120
 Currently allocated system resources, 120

T

Teaming, 107
Temperature monitoring, 64
Tools, 78
Touch screen
 Operation, 67, 69
Trigger register
 Watchdog, 123

U

UL approval, 86
USB, 114
USB 2.0
 Port, 117
USB 3.0
 Interface, 117

V

Ventilation slits, 39

W

Warranty, 23
Watchdog, 65
 Enable register, 123
 Monitoring function, 65
 Monitoring times, 65
 Trigger register, 123
Windows 7 Ultimate
 Data backup, 83
Windows Embedded Standard
 Data backup, 83
Windows XP Professional
 Data backup, 83

