

SIEMENS

SIMATIC

Industrial PC SIMATIC IPC427E

Operating Instructions

Preface

Overview

1

Safety Instructions

2

Installing and connecting the device

3

Commissioning the device

4

Extended device functions

5

Expanding and assigning parameters to the device

6

Device maintenance and repair

7

Technical specifications

8

Technical support

A

Markings and symbols

B



List of abbreviations

C

Legal information

Warning notice system

This manual contains notices you have to observe in order to ensure your personal safety, as well as to prevent damage to property. The notices referring to your personal safety are highlighted in the manual by a safety alert symbol, notices referring only to property damage have no safety alert symbol. These notices shown below are graded according to the degree of danger.

 DANGER
indicates that death or severe personal injury will result if proper precautions are not taken.
 WARNING
indicates that death or severe personal injury may result if proper precautions are not taken.
 CAUTION
indicates that minor personal injury can result if proper precautions are not taken.
NOTICE
indicates that property damage can result if proper precautions are not taken.

If more than one degree of danger is present, the warning notice representing the highest degree of danger will be used. A notice warning of injury to persons with a safety alert symbol may also include a warning relating to property damage.

Qualified Personnel

The product/system described in this documentation may be operated only by **personnel qualified** for the specific task in accordance with the relevant documentation, in particular its warning notices and safety instructions. Qualified personnel are those who, based on their training and experience, are capable of identifying risks and avoiding potential hazards when working with these products/systems.

Proper use of Siemens products

Note the following:

 WARNING
Siemens products may only be used for the applications described in the catalog and in the relevant technical documentation. If products and components from other manufacturers are used, these must be recommended or approved by Siemens. Proper transport, storage, installation, assembly, commissioning, operation and maintenance are required to ensure that the products operate safely and without any problems. The permissible ambient conditions must be complied with. The information in the relevant documentation must be observed.

Trademarks

All names identified by ® are registered trademarks of Siemens AG. The remaining trademarks in this publication may be trademarks whose use by third parties for their own purposes could violate the rights of the owner.

Disclaimer of Liability

We have reviewed the contents of this publication to ensure consistency with the hardware and software described. Since variance cannot be precluded entirely, we cannot guarantee full consistency. However, the information in this publication is reviewed regularly and any necessary corrections are included in subsequent editions.

Preface

Purpose of the Operating Instructions

These operating instructions contain all the information you need for commissioning and operating the SIMATIC IPC427E.

It is intended both for programming and testing personnel who commission the device and connect it with other units (automation systems, programming devices), as well as for service and maintenance personnel who install add-ons or carry out fault/error analyses.

Basic knowledge required

A solid background in personal computers and Microsoft operating systems is required to understand this manual. General knowledge in the field automation control engineering is recommended.

Scope of the operating instructions

These operating instructions are valid for all versions of the SIMATIC IPC427E.

Approbations

You will find additional information in "Certificates and approvals (Page 95)".

CE marking

You will find additional information in "Certificates and approvals (Page 95)".

Standards

For more information, refer to sections "Certificates and approvals (Page 95)" and "Technical specifications (Page 105)".

Position in the information landscape

The IPC documentation comprises:

- SIMATIC IPC427E Quick Install Guide with product information about the device, for example important notes
- SIMATIC IPC427E Operating Instructions

The documentation is supplied with the IPC in multiple languages in electronic form as a PDF file on the USB stick supplied in the documentation package.

Conventions

The terms "PC" and "device" are sometimes used to refer to the SIMATIC IPC427E in this documentation.

The term "Windows Embedded Standard" is used throughout to refer to "Windows Embedded Standard 7". "Windows 7" is used as an abbreviation for "Windows 7 Ultimate".

Note

A note is important information about the product, handling the product or a reference to specific sections of the documentation that require special consideration.

History

The following editions of these operating instructions have already been published:

Edition	Comments
09/2016	First edition
09/2017	Amendment regarding Windows 10 Corrections

Table of contents

	Preface	3
1	Overview.....	9
1.1	Product description	9
1.1.1	Applications.....	10
1.1.2	Features.....	10
1.2	Design of the device	13
1.2.1	Interfaces and operating elements	13
1.2.2	Status displays.....	14
1.3	Accessories.....	15
2	Safety Instructions	17
2.1	General safety instructions	17
2.2	Notes on usage.....	21
3	Installing and connecting the device.....	23
3.1	Preparing for installation	23
3.1.1	Checking the delivery package.....	23
3.1.2	Identification data of the device	25
3.1.3	Permitted mounting positions	27
3.2	Installing the device	29
3.2.1	Mounting instructions	29
3.2.2	Installation on a DIN rail.....	31
3.2.2.1	Attaching the DIN rail bracket	31
3.2.2.2	Mounting on DIN rails	32
3.2.3	Wall mounting	33
3.2.4	Upright mounting.....	34
3.3	Connecting the device	35
3.3.1	Notes on connecting	35
3.3.2	Connecting the protective conductor	37
3.3.3	Connecting peripheral equipment.....	38
3.3.4	Connecting expansion cards	39
3.3.5	Connecting the terminal.....	40
3.3.6	Connecting the power supply	41
3.3.7	Connecting the device to networks.....	42
3.3.8	Installing the strain relief	43
3.3.9	Securing the lines	44

4	Commissioning the device	45
4.1	General information on commissioning	45
4.2	Initial commissioning	47
4.3	Windows Action Center	48
4.4	IPC Driver and Tools	48
5	Extended device functions	49
5.1	Monitoring Functions	49
5.1.1	Overview of the monitoring functions	49
5.1.2	Temperature monitoring/display	50
5.1.3	Watchdog (WD)	51
5.1.4	Battery monitoring	52
5.1.5	Mass storage monitoring	52
5.2	Unified Write Filter (UWF)	52
5.3	Enhanced Write Filter (EWF)	53
5.4	File Based Write Filter (FBWF)	56
5.5	Buffer memory NVRAM	58
5.6	Operation without monitor and keyboard	58
5.7	Active Management Technology (AMT)	58
5.8	Trusted Platform Modul (TPM)	60
6	Expanding and assigning parameters to the device	61
6.1	Installing and removing the memory module	61
6.1.1	Opening the device	61
6.1.2	Opening the device containing expansion cards	63
6.1.3	Replacing memory modules	64
6.2	Installing and removing CFast cards	66
6.3	Installing and removing PCIe cards	68
6.4	Assigning CPU power consumption parameters	71
7	Device maintenance and repair	73
7.1	Maintenance	73
7.2	Repair information	73
7.3	Installing and removing hardware	76
7.3.1	Installing and removing the backup battery	76
7.3.2	Changing storage media	78
7.3.2.1	Replacing a HDD/SSD	78
7.4	Installing the software	81
7.4.1	Reinstalling the operating system	81
7.4.1.1	General installation procedure	81
7.4.1.2	Restoring the factory state	83
7.4.1.3	Windows 7 / Windows 10	84
7.4.1.4	Windows Embedded Standard	87

7.4.2	Partitioning the data storage medium	89
7.4.2.1	Partitioning in Windows Embedded Standard 7	89
7.4.2.2	Setting up the partitions under Windows 7 Ultimate and Windows 10	90
7.4.2.3	Adapting the partitions under Windows 7 Ultimate and Windows 10	91
7.4.3	Installing drivers and software	92
7.4.4	Update installation	93
7.4.4.1	Updating the operating system	93
7.4.4.2	Installing or updating application programs and drivers	93
7.4.5	Backing up data	93
7.5	Recycling and disposal	93
8	Technical specifications	95
8.1	Certificates and approvals	95
8.2	Declaration of conformity	97
8.2.1	CE marking	97
8.2.2	Electromagnetic compatibility, Industrial and Residential Areas	97
8.3	Directives and declarations	98
8.3.1	ESD guideline	98
8.4	Dimension drawings	101
8.4.1	Dimension drawing - mounting on a DIN rail	101
8.4.2	Dimension drawing - wall-mounting	102
8.4.3	Dimension drawing - vertical mounting	103
8.4.4	Dimension drawing - device with expansion cards	104
8.5	Technical specifications	105
8.5.1	General technical specifications	105
8.5.2	Ambient conditions	108
8.5.3	Power demand of the components	110
8.5.4	Integrated DC power supply	110
8.5.5	Typical power consumption	111
8.6	Hardware descriptions	112
8.6.1	External ports	112
8.6.1.1	COM1 / COM2	112
8.6.1.2	CFAST	113
8.6.1.3	DisplayPort	114
8.6.1.4	Ethernet	115
8.6.1.5	USB 3.0 port	115
8.6.2	Internal ports	116
8.6.2.1	PCIe card	116
8.6.3	System resources	118
8.6.3.1	Currently allocated system resources	118
8.6.3.2	Allocation of system resources	118
8.6.4	I/O Address Areas	120
8.6.4.1	Overview of the internal module registers	120
8.6.4.2	Watchdog enable register / 066h select register (read/write, address 062h)	120
8.6.4.3	Watchdog trigger register (read only, address 066h)	122
8.6.4.4	Output register user LED L1/L2/L3 (read/write, address 404Eh)	122
8.6.4.5	Battery status register (read-only, address 404Dh)	123
8.6.4.6	NVRAM address register	123

8.7	BIOS description	124
8.7.1	Overview	124
8.7.2	Opening the BIOS selection menu.....	125
8.7.3	Structure of the BIOS Setup menu	126
8.7.4	Exit menu	128
8.7.5	BIOS update.....	129
8.7.6	Alarm, error and system messages	131
8.8	Active Management Technology (AMT)	132
8.8.1	Introduction	132
8.8.2	Overview of AMT.....	133
8.8.3	Enabling Intel® AMT / basic configuration.....	133
8.8.4	Resetting the Intel® AMT to the default settings and disabling AMT	135
8.8.5	Determining the network address	136
8.8.6	Forcing user consent	136
8.9	Functional scope in Windows	137
8.9.1	Windows Embedded Standard 7	137
A	Technical support.....	139
A.1	Service and support	139
A.2	Troubleshooting	140
A.3	Notes on the use of third-party modules.....	141
B	Markings and symbols	143
B.1	Overview	143
B.2	Safety	143
B.3	Operator controls	143
B.4	Certificates, approvals and markings.....	144
B.5	Interfaces	145
C	List of abbreviations	147
	Glossary	153
	Index	161

Overview

1.1 Product description

The SIMATIC IPC427E provides high-level industrial functionality.

- Compact design
- Maintenance-free operation
- High degree of ruggedness

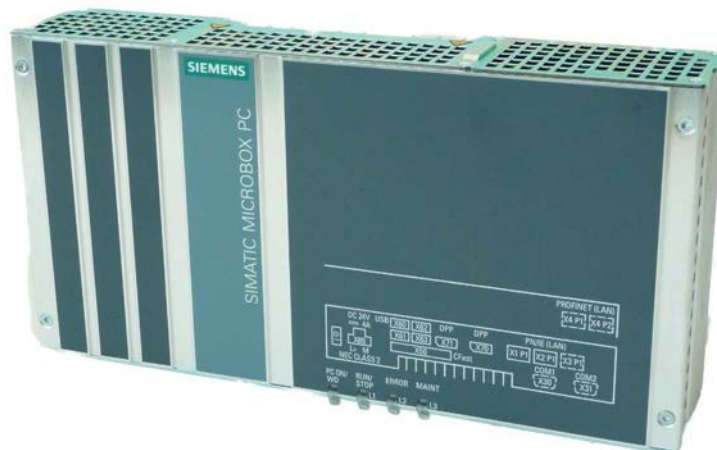

1.1.1 Applications

The device provides industrial PC systems for high-performance and space-saving applications in particular in the field of machine, systems and switchgear cabinet engineering:

- Measuring and controlling process and machine data, for example, automated washing systems, assembling machines and packaging machines
- Operating and visualization tasks with separate monitors or displays, for example, information terminals and large-scale displays in automotive production
- Data logging and processing, for example, system data logging and distributed process control

1.1.2 Features

Basic data	
Installation	<ul style="list-style-type: none"> • Installation on a DIN rail • Wall mounting • Vertical mounting
Processor	<ul style="list-style-type: none"> • Intel® Celeron® Processor G3902E (2M Cache, 1.6 GHz) • Intel® Core™ i3-6102E Processor (3M Cache, 1.9 GHz) • Intel® Core™ i5-6442EQ Processor (6M Cache, up to 2.7 GHz) • Intel® Xeon® Processor E3-1505L v5 (8M Cache, up to 2.8 GHz)
Main memory	Memory modules without ECC: <ul style="list-style-type: none"> • 4 GB DDR4-SDRAM SODIMM • 8 GB DDR4-SDRAM SODIMM • 16 GB DDR4-SDRAM SODIMM Memory module with ECC (not combinable with i5 CPU): <ul style="list-style-type: none"> • 8 GB DDR4-SDRAM SODIMM • 16 GB DDR4-SDRAM SODIMM
Free slots for expansion cards	Up to 2 × PCIe cards (optional), depending on enclosure version; max. 175 mm long
Graphics	<ul style="list-style-type: none"> • Intel® HD Graphics 510 / 530 / P530 (depending on CPU type) • 2 x DisplayPort, maximum resolution 4096 x 2304 pixels • Graphics memory is claimed in main memory (dynamic UMA)
Power supply	24 V DC (-20%/+20%) max. 4 A
Conditions of use	Operation without fan

Basic data	
Drives and storage media	
CFAST card	Can be used optionally as boot drive or additional data memory. <ul style="list-style-type: none"> • 2 GB • 4 GB • 8 GB • 16 GB • 30 GB
Hard disk	2.5", ≥ 320 GB, SATA (optional)
SSD (Solid State Disk)	2.5", ≥ 80 GB SATA (optional)
USB stick	External, can be connected via USB interface
Ports	
Serial	COM1 / COM2 (RS 232, RS 422, RS 485 configurable), optional
Graphics	2 x DisplayPort DPP (DVI via DP++ to DVI adapter possible)
USB	4 x USB 3.0, simultaneous operation of max. 2 x high current ports, backward compatible with USB 2.0/1.1
Ethernet	2 x (3 x optional) RJ45 (10/100/1000 Mbps), teaming-capable
Keyboard, mouse	Connected via external USB port

Extended device functions	
Temperature monitoring	<ul style="list-style-type: none"> • When permitted temperature range is exceeded • Warnings can be analyzed by application program (local, via LAN)
Watchdog	<ul style="list-style-type: none"> • Monitoring function for program execution • Restart can be parameterized in the event of a fault • Warnings can be analyzed by application program (local, via LAN)
LED display	4 LEDs for displaying system statuses; 3 of these can be freely programmed by the user
Transient voltage interruption	Up to 15 ms buffer time at full load
Buffer memory	512 KB optional
TPM	Integrated Trusted Platform Module, optional, according to TPM 2.0 standard

Software	
Operating systems	
Available	<ul style="list-style-type: none">• None• Windows Embedded Standard 7, SP1• Windows 7 Ultimate, SP1• Windows 10 IoT Enterprise LTSC 2016, 64-bit
Project-specific	<ul style="list-style-type: none">• LINUX• QNX• VxWorks

1.2 Design of the device

1.2.1 Interfaces and operating elements

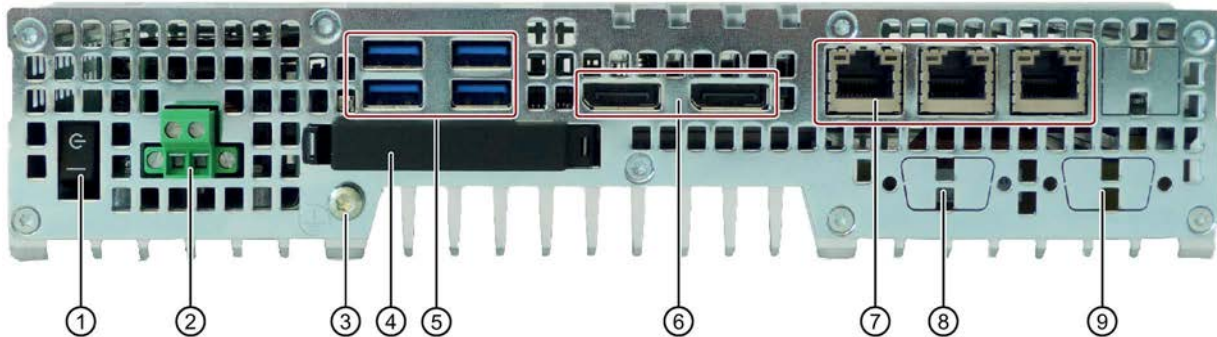

- | | |
|-------------------------------|--|
| ① On/off switch | The on/off switch does not isolate the device from the power supply. Position "OFF", when the "_" symbol is pressed. Position "OFF" is the delivery state. |
| ② 24V DC | Power supply connection |
| ③ Protective conductor | Protective conductor terminal |
| ④ Memory card slot | Slot for CFast card with cover |
| ⑤ 4 × USB | USB 3.0 high current, backward compatible with USB 2.0/1.1 |
| ⑥ 2 x DisplayPort | DisplayPort connection for digital monitor |
| ⑦ 3 × Ethernet / 2 x Ethernet | RJ45 interface (10/100/1000 Mbps); 2 x RJ45 (optional) |
| ⑧ COM1 | Serial interface (optional) |
| ⑨ COM2 | Serial interface (optional) |

1.2.2 Status displays

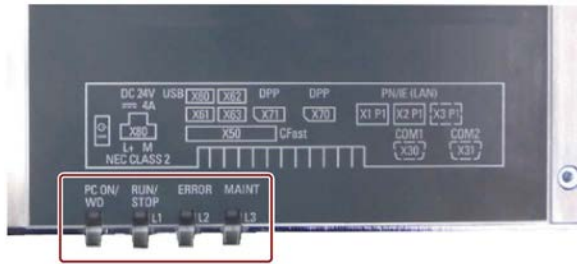

LED	State	Description
PC ON/WD	Off	-
	Green	BIOS ready to boot; PC running
	Flashing green/yellow (1 Hz)	BIOS in POST, power switch on
	Yellow	Idle state
	Flashing red (1 Hz)	Watchdog status display: active
RUN/STOP / L1	Off	-
	Green	Can be controlled by user program
	Yellow	Can be controlled by controller program (e.g. WinAC)
ERROR / L2	Off	-
	Red	-
	Flashing red	Can be controlled by user program or controller program (e.g. WinAC)
MAINT / L3	Off	-
	Yellow	-
	Red	Can be controlled by controller program (e.g. WinAC)

For additional information on controlling the LEDs or the NVRAM with a Windows operating system, please refer to Output register user LED L1/L2/L3 (read/write, address 404Eh) (Page 122). Example programs for controlling the LEDs on Windows operating systems are available on the Customer Support page of Siemens Industry Automation and Drive Technologies. (<http://www.siemens.com/automation/service&support>)

1.3 Accessories

Siemens offers accessories not included in the scope of delivery for the device. For more information on available accessories, refer to the Internet at:

Industry Mall (<https://mall.industry.siemens.com>)

Expansion components and accessories (http://www.automation.siemens.com/mcms/pc-based-automation/en/industrial-pc/expansion_components_accessories)

SIMATIC IPC CFast cards

- 2 GB optional or
- 4 GB optional or
- 8 GB optional or
- 16 GB optional or
- 30 GB optional



Memory modules

- SO-DIMM module 4096 MB DDR4-SDRAM
- SO-DIMM module 8192 MB DDR4-SDRAM
- SO-DIMM module 16384 MB DDR4-SDRAM
- SO-DIMM module 8192 MB DDR4-SDRAM ECC
- SO-DIMM module 16384 MB DDR4-SDRAM ECC

Mounting sets

- Mounting onto standard rail
- Wall mounting
- Vertical mounting

Safety Instructions

2.1 General safety instructions

 WARNING
--

Life-threatening voltages are present with an open control cabinet

When you install the device in a control cabinet, some areas or components in the open control cabinet may be carrying life-threatening voltages.

If you touch these areas or components, you may be killed by electric shock.
--

Switch off the power supply to the cabinet before opening it.

System expansions

NOTICE

Damage through system expansions

Device and system expansions may be faulty and can affect the entire machine or plant.
--

The installation of expansions can damage the device, machine or plant. Device and system expansions may violate safety rules and regulations regarding radio interference suppression. If you install or exchange system expansions and damage your device, the warranty becomes void.

2.1 General safety instructions

Note the following for system expansions:

- Only install system expansion devices designed for this device. Contact your technical support team or where you purchased your PC to find out which system expansion devices may safely be installed.
- Observe the information on electromagnetic compatibility (Page 97).

NOTICE
"Open Type" UL508 Note that the device is classified as "Open Type" for use in the area of Industrial Control Equipment (UL508). Installation of the device in an enclosure complying with UL508 for specific permitted mounting positions (see corresponding section) is a prerequisite for approval or operation in accordance with UL508.

 WARNING
Risk of fire through expansion cards Expansion cards generate additional heat. The device may overheat and cause a fire. Please note the following: <ul style="list-style-type: none">• Observe the safety and installation instructions for the expansion cards.• If in doubt, install the device in an enclosure that is compliant with sections 4.6 and 4.7.3 of the IEC/UL/EN/DIN-EN 60950-1 standard.

Battery and rechargeable battery

 WARNING
Risk of explosion and release of harmful substances Improper handling of lithium batteries can result in an explosion of the batteries. Explosion of the batteries and the released pollutants can cause severe physical injury. Worn batteries jeopardize the function of the device. Note the following when handling lithium batteries: <ul style="list-style-type: none">• Replace used batteries in good time; see the section "Replacing the backup battery" in the operating instructions.• Replace the lithium battery only with an identical battery or types recommended by the manufacturer (order no.: A5E34734290).• Do not throw lithium batteries into fire, do not solder on the cell body, do not recharge, do not open, do not short-circuit, do not reverse polarity, do not heat above 100°C and protect from direct sunlight, moisture and condensation.

High frequency radiation

NOTICE

Unintentional operating situations

High frequency radiation, e.g. from a cellular phone, interferes with device functions and can result in malfunctioning of the device.

Persons are injured and the plant is damaged.

Avoid high-frequency radiation:

- Remove radiation sources from the environment of the device.
- Switch off radiating devices.
- Reduce the radio output of radiating devices.
- Observe the information on electromagnetic compatibility (Page 97).

ESD Guideline



Electrostatic sensitive devices can be labeled with an appropriate symbol.

NOTICE

Electrostatic sensitive devices (ESD)

When you touch electrostatic sensitive components, you can destroy them through voltages that are far below the human perception threshold.

If you work with components that can be destroyed by electrostatic discharge, observe the ESD Guideline (Page 98).

Industrial Security

Siemens provides products and solutions with industrial security functions that support the secure operation of plants, systems, machines and networks.

In order to protect plants, systems, machines and networks against cyber threats, it is necessary to implement – and continuously maintain – a holistic, state-of-the-art industrial security concept. Siemens' products and solutions only form one element of such a concept.

Customer is responsible to prevent unauthorized access to its plants, systems, machines and networks. Systems, machines and components should only be connected to the enterprise network or the internet if and to the extent necessary and with appropriate security measures (e.g. use of firewalls and network segmentation) in place.

Additionally, Siemens' guidance on appropriate security measures should be taken into account. For more information about industrial security, please visit (<http://www.siemens.com/industrialsecurity>).

2.1 General safety instructions

Siemens' products and solutions undergo continuous development to make them more secure. Siemens strongly recommends to apply product updates as soon as available and to always use the latest product versions. Use of product versions that are no longer supported, and failure to apply latest updates may increase customer's exposure to cyber threats.

To stay informed about product updates, subscribe to the Siemens Industrial Security RSS Feed under (<https://support.industry.siemens.com>).

Disclaimer for third-party software updates

This product includes third-party software. Siemens AG only provides a warranty for updates/patches of the third-party software, if these have been distributed as part of a Siemens software update service contract or officially released by Siemens AG. Otherwise, updates/patches are undertaken at your own risk. You can find more information about our Software Update Service offer on the Internet at Software Update Service (<http://www.automation.siemens.com/mcms/automation-software/en/software-update-service>).

Notes on protecting administrator accounts

A user with administrator privileges has extensive access and manipulation options in the system.

Therefore, ensure there are adequate safeguards for protecting the administrator accounts to prevent unauthorized changes. To do this, use secure passwords and a standard user account for normal operation. Other measures, such as the use of security policies, should be applied as needed.

2.2 Notes on usage

 WARNING
Risks associated with the unprotected machine or plant
According to the results of a risk analysis, certain hazard potentials associated with the unprotected machine exist. These hazards could lead to personal injury.
Avoid such hazards by taking the following precautions in accordance with the risk analysis:
<ul style="list-style-type: none">• Installation of additional safety equipment on the machine or plant. In particular, the programming, parameter assignment and wiring of the inserted I/O modules must be executed in accordance with the safety performance identified by the necessary risk analysis (SIL, PL or Cat.).• Use as intended must be validated for the device by means of a function test on the plant. These tests help you to identify programming, parameter assignment and wiring errors.• Documentation of the test results that you can enter in the relevant safety verification documents, if necessary.

Environment

NOTICE
Ambient conditions and chemical resistance
Unsuitable environmental conditions have a negative impact on device operation. Chemical substances such as cleaners or fuels may alter the color, shape and structure of the device surface, for example, the front panel.
The device may be damaged, possibly resulting in malfunctions.
For this reason, please observe the following precautions:
<ul style="list-style-type: none">• Always operate the device in closed rooms. All warranties shall be void in the case of noncompliance.• Operate the device only in accordance with the ambient conditions specified in the technical specifications.• Protect the device against dust, moisture and heat.• Do not expose the device to direct sunlight or to other strong sources of light.• Without additional safety measures, such as a supply of clean air, the device may not be used in locations with harsh operating conditions caused by acidic vapors or gases.• Observe the permitted mounting positions of the device.• Do not obstruct the venting slots of the device.• Always use suitable cleaning agents. Read the information about Chemical resistance of the HMI devices and industrial PCs (http://support.automation.siemens.com/WW/view/en/39718396) on the Internet.

Note

Use in an industrial environment without additional protective measures

The device has been designed for use in a normal industrial environment in accordance with IEC 60721-3-3 (pollutant class 3C2 for chemical influences, 3S2 for dust without sand).

Installing and connecting the device

3.1 Preparing for installation

3.1.1 Checking the delivery package

Procedure

1. When accepting a delivery, please check the packaging for visible transport damage.
2. If any transport damage is present at the time of delivery, lodge a complaint at the shipping company in charge. Have the shipper confirm the transport damage immediately.
3. Unpack the device at its installation location.
4. Keep the original packaging in case you have to transport the unit again.

Note

Damage to the device during transport and storage

If a device is transported or stored without packaging, shocks, vibrations, pressure and moisture may impact the unprotected unit. Damaged packaging indicates that ambient conditions have already had a massive impact on the device and it may be damaged.

This may cause the device, machine or plant to malfunction.

- Keep the original packaging.
 - Pack the device in the original packaging for transportation and storage.
-

5. Check the contents of the packaging and any accessories you may have ordered for completeness and damage.

3.1 Preparing for installation

- Please inform the delivery service immediately if the package contents are incomplete or damaged or do not correspond with your order. Fax the enclosed form "SIMATIC IPC/PG Quality Control Report".

 WARNING
Electric shock and fire hazard due to damaged device A damaged device can be under hazardous voltage and trigger a fire in the machine or plant. A damaged device has unpredictable properties and states. Death or serious injury could occur. Make sure that the damaged device is not inadvertently installed and put into operation. Label the damaged device and keep it locked away. Send off the device for immediate repair.

NOTICE
Damage from condensation If the device is subjected to low temperatures or extreme fluctuations in temperature during transportation, as is the case in cold weather, for example, moisture can build up on or inside the device (condensation). Moisture causes a short circuit in electrical circuits and damages the device. In order to prevent damage to the device, proceed as follows: <ul style="list-style-type: none">• Store the device in a dry place.• Bring the device to room temperature before starting it up.• Do not expose the device to direct heat radiation from a heating device.• If condensation develops, wait approximately 12 hours or until the device is completely dry before switching it on.

- Please keep the enclosed documentation in a safe place. It belongs to the device. You need the documentation when you commission the device for the first time.
- Write down the identification data of the device.

3.1.2 Identification data of the device

Unpacking the device

The device can be identified uniquely with the help of these numbers in case of repairs or theft.

Enter the identification data in the table below:

Identification data	Source	Value
Serial number	Rating plate	S VP ...
Article number of the device	Rating plate	6AG4141-...
Microsoft Windows Product Key Certificate of Authenticity (COA)	Side surface of the device	Only devices with preinstalled Windows operating systems have COA labels
Ethernet address 1	BIOS setup, "Advanced" menu	
Ethernet address 2		
Ethernet address 3 (optional)		

Rating plate

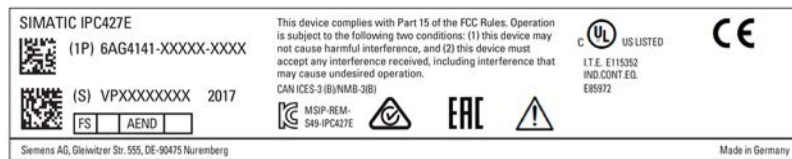

Example of a COA label

Microsoft Windows "Product Key" of the "Certificate of Authenticity" (COA):
The COA label is only attached to the side of the device when a Windows operating system is installed.

- COA label of a device with the Windows Embedded Standard 7 operating system

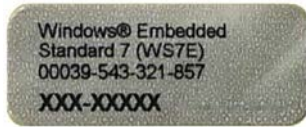

- COA label of a device with Windows 7 operating system



- COA label of a device with Windows 10 operating system



The Windows 10 COA label has an additional security feature which conceals part of the product key.

The scratch-off panel consists of a small transparent label with a silver-colored scratch coating, which was applied to conceal part of the 25-character product key. This scratch-off panel is designed to protect the product key from being obtained and used by unauthorized third parties.

You usually do not need this product key for commissioning because a valid product key has already been integrated into the pre-installed operating system.

3.1.3 Permitted mounting positions

Note

The device is only approved for operation in closed rooms.

Ensure that the required minimum clearance to other components or enclosure panels is maintained.

With horizontal mounting position:

- Underneath at least 100 mm
- Above at least 50 mm
- At least 50 mm at the side

With vertical mounting position and portrait mounting:

- Underneath at least 50 mm
- Above at least 50 mm
- At least 50 mm at the side

NOTICE

Points to note with expansion cards

Expansion cards may impose restrictions on the installation location (fire-proof enclosure) and permitted mounting positions (see Technical specifications). If the device has been fitted with expansion cards, please observe the safety and installation instructions for the expansion cards in the corresponding documentation.

If in doubt, install the device in an enclosure that is compliant with IEC/UL/EN/DIN-EN 60950-1, sections 4.6 and 4.7.3.

Horizontal mounting is the preferred position. The horizontal mounting options are as follows:

Installation on a DIN rail

The interfaces are at the bottom.

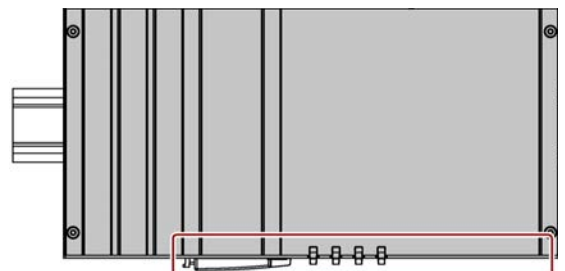

Wall mounting

The interfaces are at the bottom.

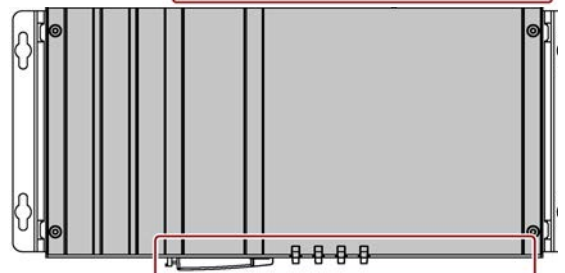

3.1 Preparing for installation

The device can be mounted vertically on DIN rails or on the wall. The figure shows the interfaces on the front.

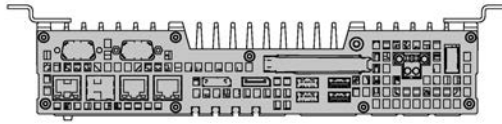

The vertical mounting options are as follows:

Wall mounting

The interfaces are at the left.

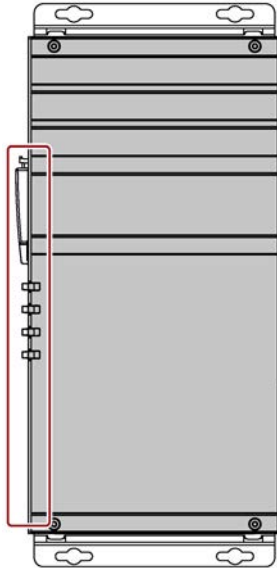

Vertical mounting

The interfaces are at the front. The power supply connection is at the top.

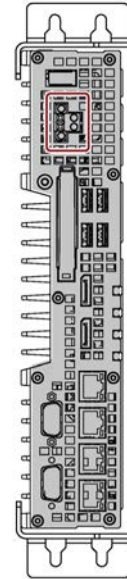

Observe the permitted temperature range for operation in the respective mounting position as defined in "Technical specifications (Page 105)".

3.2 Installing the device

3.2.1 Mounting instructions

Note the following:

- The device is only approved for operation in closed rooms.
- For installation in a control cabinet, observe the SIMATIC installation guidelines and applicable DIN/VDE requirements or other applicable country-specific regulations.
- When the device is used in the area of Industrial Control Equipment in accordance with UL508, note that the device is classified as "Open Type". The installation of the device in a housing conforming to UL508 is therefore a mandatory requirement for approval or operation in accordance with UL508.

Securing the device

NOTICE
Insufficient load carrying capacity
If the wall it is mounted on does not have a sufficient load-bearing capacity, the device may fall and be damaged.
Ensure that the mounting surface on the wall can bear four times the total weight of the device, including fixing elements.

NOTICE
Incorrect fixing elements
The device may not be securely fitted if you use anchors and screws other than those specified below for mounting. The device can fall and may be damaged.
Use only the anchors and screws specified in the following table.

3.2 Installing the device

Use the following fasteners:

- Installation on a DIN rail

Material	Bore diameter	Fastener
Metal, min. 2 mm thickness	5 mm	<ul style="list-style-type: none"> • 2 x M4 screws • 2 x M4 nuts
Concrete	6 mm, 40 mm depth	<ul style="list-style-type: none"> • 4 x dowels, Ø 6 mm, 40 mm length • 4 x screws, Ø 4 mm, 40 mm length
Plasterboard, min. 13 mm thickness	14 mm	4 x toggle bolts, Ø 4 mm, 50 mm length

- Wall mounting

Material	Bore diameter	Fastener
Concrete	6 mm, 40 mm depth	<ul style="list-style-type: none"> • 4 x dowels, Ø 6 mm, 40 mm length • 4 x screws, Ø 4 mm, 40 mm length
Plasterboard, min. 13 mm thickness	14 mm	4 x toggle bolts, Ø 4 mm, 50 mm length

- Vertical mounting

Material	Bore diameter	Fastener
Concrete	6 mm, 40 mm depth	<ul style="list-style-type: none"> • 4 x dowels, Ø 6 mm, 40 mm length • 4 x screws, Ø 4 mm, 40 mm length
	8 mm, 40 mm deep	<ul style="list-style-type: none"> • Dowel, Ø 8 mm, 40 mm length • Screw, Ø 5 mm, 40 mm length
Plasterboard, min. 13 mm thickness	14 mm	Toggle bolt, Ø 4 mm, 50 mm length

3.2.2 Installation on a DIN rail

3.2.2.1 Attaching the DIN rail bracket

Before you can install the device on a DIN rail, you will need to attach the DIN rail clip to the device.

The fasteners and screws required are supplied with the device for the selected mounting option (as specified in order number).

Requirement

- 1 DIN rail clip
- 4 screws
- 1 T20 screwdriver

Procedure

1. Fasten the DIN rail clip with four screws.

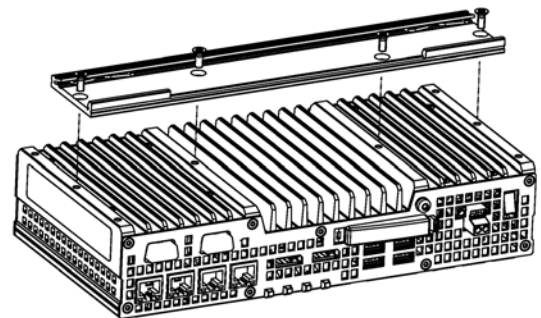

3.2.2.2 Mounting on DIN rails

Requirement

- DIN rail, 35 mm standard profile
The DIN rail is installed at the installation site.

Note

Ensure that the wall or ceiling can hold four times the total weight of the device including DIN profile rail and additional expansion cards. See Mounting instructions (Page 29).

Procedure

Installation

1. Place the device and rail clip on the upper edge of the standard profile rail at the position shown.

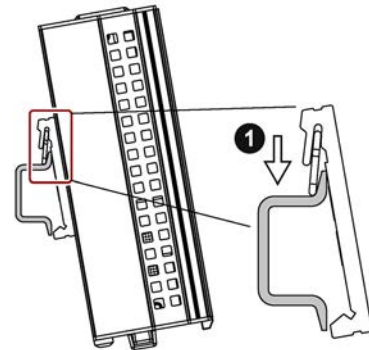

2. Push down the device. Once the rail clip is over the bottom edge of the standard profile rail, push the device towards the standard profile rail. You will hear the device click into place.

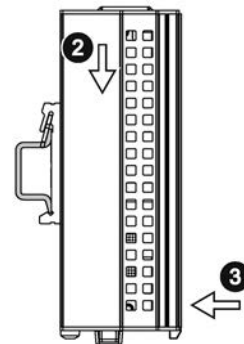

Removal

1. Push down the device until it is released by the rail clips.
2. Swing the device out of the standard profile rail.
3. Lift the device up and off.

3.2.3 Wall mounting

The fasteners and screws required are supplied with the device for the selected mounting option (as specified in order number).

Requirement

- 2 mounting brackets
- 6 screws
- 1 T20 screwdriver

Procedure

1. Secure each mounting bracket with 3 screws.

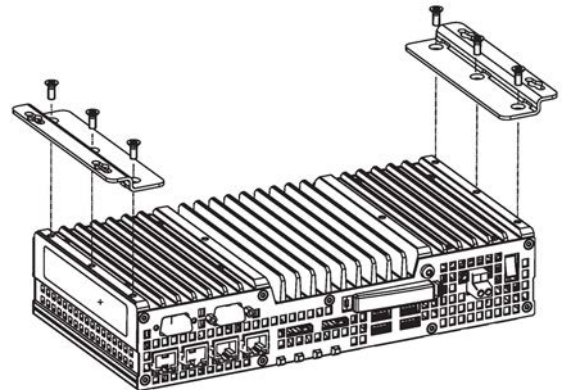

3.2.4 Upright mounting

The fasteners and screws required are supplied with the device for the selected mounting option (as specified in order number).

Requirement

- 2 mounting brackets
- 6 screws
- 1 T20 screwdriver

Procedure

1. Secure each mounting bracket with three screws.

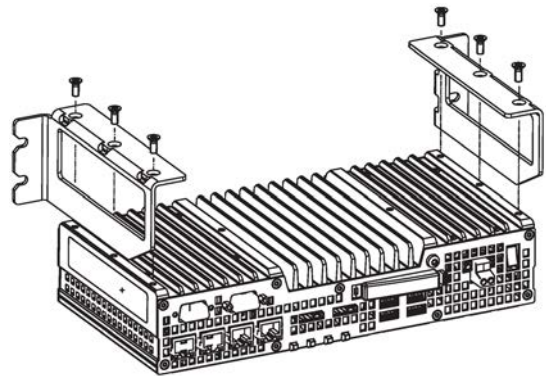

3.3 Connecting the device

3.3.1 Notes on connecting

 WARNING
Risk of fire and electric shock
The on/off switch does not isolate the device from the power supply. Risk of electric shock if the device is opened incorrectly or defective. There is also a risk of fire if the device or connecting lines are damaged.
You should therefore protect the device as follows:
<ul style="list-style-type: none">• Always pull out the power plug when you are not using the device or if the device is defective. The power plug must be freely accessible.• Connect the device to a protective conductor as instructed, see section "Connecting the protective conductor".• Use a central isolating switch in the case of cabinet installation.

 WARNING
Risk of lightning strikes
A lightning flash may enter the mains cables and data transmission cables and jump to a person.
Death, serious injury and burns can be caused by lightning.
Take the following precautions:
<ul style="list-style-type: none">• Disconnect the device from the power supply in good time when a thunderstorm is approaching.• Do not touch mains cables and data transmission cables during a thunderstorm.• Keep a sufficient distance from electric cables, distributors, systems, etc.

NOTICE
Fault caused by I/O devices
The connection of I/O devices can cause faults in the device.
The result may be personal injury and damage to the machine or plant.
Note the following when connecting I/O devices:
<ul style="list-style-type: none">• Read the documentation of the I/O devices. Follow all instructions in the documentation.• Only connect I/O devices which are approved for industrial applications in accordance with EN 61000-6-2 and IEC 61000-6-2.• I/O devices that are not hotplug-capable may only be connected after the device has been disconnected from the power supply.

NOTICE

Damage through regenerative feedback

Regenerative feedback of voltage to ground by a connected or installed component can damage the device.

Connected or built-in I/Os, for example, a USB drive, are not permitted to supply any voltage to the device. Regenerative feedback is generally not permitted.

3.3.2 Connecting the protective conductor

The protective conductor connection is needed to protect the device. The protective conductor discharges dangerous currents, triggering a surge protection switch. The protective conductor also improves the discharge of interference generated by external power cables, signal cables or cables for I/O devices to ground.

WARNING

Electrical shock hazard and risk of fire

Internal components of a faulty device may carry dangerous voltages that pose the risk of fire or electrical shock. Risk of death and serious injury.

- Always connect the ground conductor before you commission the device.
- The protective conductor connection on the device must be connected to the protective conductor of the control cabinet or system in which the device is installed.
- Never operate the device without protective conductor.
- Take a faulty device out of service immediately and mark it accordingly.

Requirement

- The device has been installed.
- 1 protective conductor, minimum cross section 2.5 mm²
- 1 T20 screwdriver
- 1 x M4 cable lug

Procedure

1. Crimp the cable lug onto the protective conductor.
2. Screw the cable lug onto the protective conductor connection as shown.



3. Wire the protective conductor to the protective conductor connection of the control cabinet in which the device is installed.

3.3.3 Connecting peripheral equipment

Note

Observe suitability for industrial applications

Only connect I/O devices that are suitable for industrial applications in accordance with EN IEC 61000-6-2.

Note

I/O devices capable of hot-plugging (USB)

Hot-plug I/O devices (USB) may be connected while the PC is in operation.

NOTICE

Non-hot-plug I/O devices

I/O devices that do not support hot-plugging may not be connected until the device is powered off. Strictly adhere to the specifications in the I/O manuals.

Note

Wait at least ten seconds before you reinsert USB devices.

Note that the EMC immunity of standard USB devices is designed only for office environments. These USB devices are appropriate for handling commissioning and service tasks. Only industrial grade USB devices are permitted for use in industrial environments. The USB devices are developed and marketed by the respective supplier. The respective product supplier provides support for the USB devices. The manufacturer's terms of liability shall apply.

Note

A monitor should be connected and switched on before device booting to ensure it is correctly detected and run by the BIOS and the operating system. The screen may otherwise remain dark.

Note

The connected or built-in I/Os should not introduce a counter emf into the device.

A counter e.m.f. greater than 0.5 V to ground on the + 3.3 V DC / + 5 V DC / + 12 V DC due to a connected or integrated component can prevent normal operation or even destroy the computer.

When measuring the counter emf, remember the following:

- The computer in question must be turned off.
 - During the measurement, all cables from the plant to the computer should be connected.
 - All other components in the plant must be active.
-

3.3.4 Connecting expansion cards

This section applies to devices with expansion cards.

The expansion card interface is protected by a cover. There are two holes in the cover for wiring.

Requirement

- The device is switched off.

Procedure

In this example, the expansion card is a USB expansion card.

1. Open the cover by pushing the indicated latching hooks in the direction of the arrow. Open the cover in the direction of the arrow and lift it off. You can now access the expansion card interfaces.

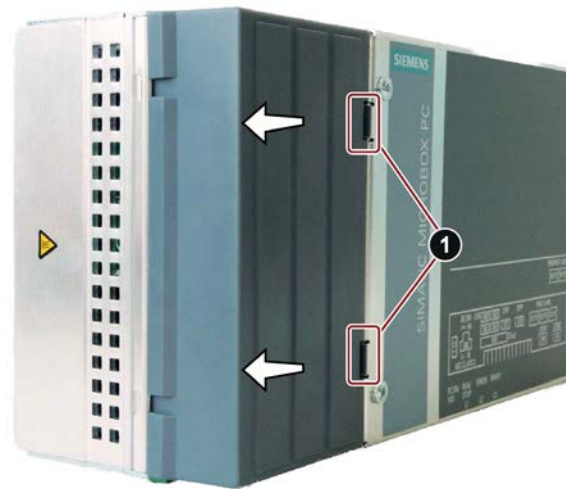

2. Connect the cable to one of the indicated slots.
3. Attach the cover at the points shown and close it. Make sure that the latching hooks snap into place so that the cover is secured.

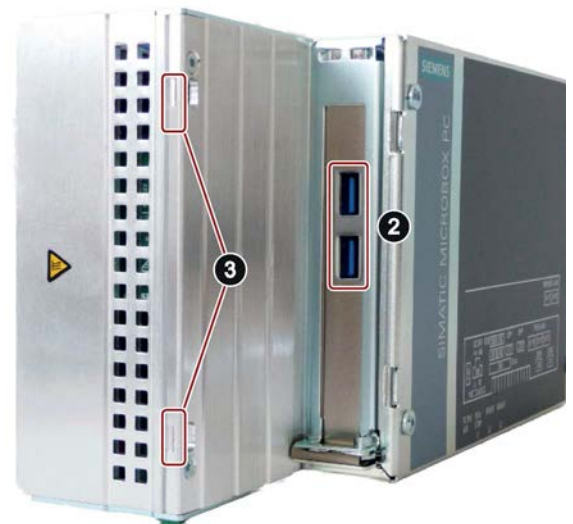

See also

Dimension drawing - device with expansion cards (Page 104)

3.3.5 Connecting the terminal

The connection terminal for connecting the power supply is fitted to the device. The connection terminal is designed for cores with a cross-section of between 0.25 mm² and 2.5 mm². Only connect cores with a cross-section of ≥ 0.5 mm².

You can use either semi-rigid or flexible cables. You do not need to use end sleeves.

Requirements

- 1 connection terminal
- 1 0.5 x 3 Philips screwdriver

Procedure

NOTICE

Damage to the device

Do not adjust the screws in the connection terminal when it is plugged into the device. The pressure of the screwdriver on the connection terminal and the socket can damage the device.

Connect the wires to the connection terminal when it is not plugged in.

Note

Make sure that the cores are connected to the correct terminals. Observe the labeling for the contacts on the front cover of the device.

1. Connect the lines as shown. Make sure the connection terminal is in the correct position as shown.

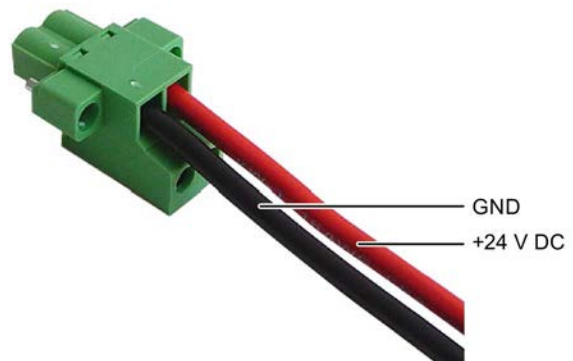

3.3.6 Connecting the power supply

Please note the following to ensure you operate the device safely and in accordance with regulations:

WARNING

Risk of fire and electric shock

The on/off switch does not isolate the device from the power supply. Risk of electric shock if the device is opened incorrectly or defective. There is also a risk of fire if the device or connecting cables are damaged.

Death or serious bodily injury can result.

You should therefore protect yourself and the device as follows:

- Always pull out the power plug when you are not using the device or if the device is defective. The power plug must be freely accessible.
- Connect the device to a protective conductor as instructed (see section "Connecting the protective conductor").
- Use a central isolating switch for cabinet installation.

Note

The device should only be connected to a 24 V DC power supply which meets the requirements of safe extra low voltage (SELV) according to IEC/EN/DIN EN/UL 60950-1. The power supply must meet the requirement NEC Class 2 or LPS according to the IEC/EN/DINEN/UL 60950-1.

The device has reverse polarity protection.

Requirement

- The device has been installed.
- The protective conductor is connected.
- 1 wired terminal.
The corresponding 24 V DC power supply is off.
- 1 0.5 × 3 Philips screwdriver

Procedure

1. Insert the terminal at the marked position.
2. Secure the terminal using the integrated screws.

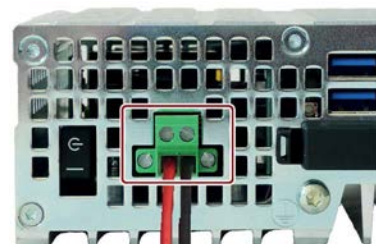

3.3.7 Connecting the device to networks

The options for integrating the device into existing or planned system environments and networks are as follows:

Ethernet

The integrated Ethernet interfaces can be used for communication and for data exchange with automation devices such as SIMATIC S7.

For this, you need TIA Portal, STEP 7, WinCC, WinCC flexible, WinAC and SIMATIC NET.

Note

To use the Windows reboot with the SIMATIC CPU1507S (F) Software Controller on the SIMATIC IPC427E, assign the Ethernet interfaces X2 or X3 to the PC station in STEP 7.

Industrial Ethernet

You can establish a network between the device and other PCs via Industrial Ethernet. The on-board LAN interfaces are (Twisted-Pair) TP interfaces that support data transmission rates of 10/100/1000 Mbps.

Note

You need a category 6 Ethernet cable for operation at 1000 Mbps.

PROFINET

PROFINET can be operated via:

- Standard Ethernet interfaces (RT)

SIMATIC NET

Use this software package to create, operate and configure an innovative network for Field & Control level. Information on this can be found on the SIMATIC NET Manual Collection CD. The software package and the documentation are not included in the product package.

Additional information

You will find additional information in the catalog and on the Internet at Industry Mall, the ordering system for automation and drive technology (<https://mall.industry.siemens.com>).

3.3.8 Installing the strain relief

Strain relief for the device is provided in the scope of delivery.

Requirement

- 1 strain relief
- 2 screws
- 1 T10 screwdriver

Procedure

Installation

1. Removed the indicated countersunk screws and fasten the strain relief at the indicated points.

Use the oval head screws included with the strain relief.



Removal

Follow the steps for installation in reverse order.

3.3.9 Securing the lines

Secure each line connected to the device to the strain relief using a cable tie. The cable ties required are not included.

Requirement

- Up to 6 cable ties for USB, Ethernet
Cable tie width 3 mm max.
- 1 cutting tool

Procedure

1. Pass the cable tie around the strain relief bar and secure the cables as shown.
2. Cut off the protruding ends of the cable ties.

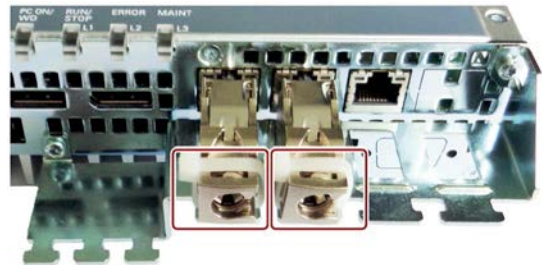

Commissioning the device

4.1 General information on commissioning

⚠ CAUTION**Danger of burns**

The surface of the device can reach temperatures of over 70 °C. Any unprotected contact may cause burns.

Avoid direct contact during operation of the device. Touch the device only with appropriate protective gloves.

Note**Windows 10 - Read the UWF information**

The configurable write filter (Unified Write Filter) is available with Windows 10.

Read the UWF information if you activate and use it, otherwise you may experience data loss.

Note**Windows Embedded Standard 7**

Read the EWF and FBWF information

Two configurable write filters (Enhanced Write Filter and File Based Write Filter) are provided with Windows Embedded Standard. Read the EWF/FBWF information if you activate and use them, otherwise you may experience data loss.

- Enhanced Write Filter (EWF) (Page 53)
- File Based Write Filter (FBWF) (Page 56)

Note**Configuring memory cards in the device**

Memory cards used in a device need to be configured on that device. Memory cards configured on other devices will not boot as the drive parameters will be different.

Requirement

- The device is connected to the power supply.
- The protective conductor is connected.
- The connection cables are plugged in correctly.
- The following hardware is available for initial commissioning:
 - One USB keyboard
 - One USB mouse
 - A monitor/display

4.2 Initial commissioning

If the device was ordered and delivered with operating system, the operating system pre-installed on the drive is set up automatically after the initial switch-on.

NOTICE

Faulty installation

If you change the default values in the BIOS Setup or if you turn off the device during installation, you disrupt the installation and the operating system is not installed correctly. The operating safety of the device and the plant is at risk.

Do not switch off the device during the entire installation process. Do not change the default values in the BIOS Setup.

Procedure

1. Set the on/off switch to the "ON" position.

The "PC ON/WD" LED flashes alternately green and yellow to indicate the progress of the BIOS self-test during device booting. After the completion of the BIOS self-test, the "PC ON/WD" LED is continuously lit green.

During the self-test, the following message appears:

```
Press Esc for Boot Options
```

2. Wait for the message to disappear.

3. Follow the instructions on the screen.

The following steps are required only when switching on the device for the first time after delivery:

4. Make the region and language settings.

If you want your system language to be international, select English. Information about changing the region and language settings is available in the section "Servicing and maintaining the device", under "Installing software".

Note

Once the operating system has been set up, the device may restart.

5. Type in the product key as required.

The product key is located below the identification data of the device on the "Certificate of Authentication" COA label, in the "Product Key" line.

6. If the device is connected with a SIMATIC Industrial Flat Panel, the setup of the SIMATIC IPC Panel Drivers and Tools software is started automatically after operating system installation (see next section).

The installation of the operating system is complete.

4.3 Windows Action Center

The Action Center checks the status of the device with regard to the important safety aspects listed below. If a problem is found, the Action Center provides recommendations on how you can better protect the device.

Functions

- **Firewall:** The Windows Firewall adds protection to the device by blocking network or Internet access to the device by unauthorized users. The firewall is enabled in the delivery state.
- **Antivirus software:** Antivirus programs add protection to the device by searching for and eliminating viruses and other security threats. No antivirus software is installed in the delivery state.
- **Automatic updates:** Using the Automatic Update feature allows Windows to regularly search for the latest critical updates for the device and to install them automatically.
You can enable or disable this option for Windows 7 and Windows 10 during commissioning of Windows.
- **User Account Control:** User Account Control issues a warning when programs attempt to modify important Windows settings. You can then either acknowledge this warning or prevent the program from changing the Windows settings.

This option is enabled in the delivery state for Windows 7 and Windows 10.

4.4 IPC Driver and Tools

Panel description - Panel Drivers and Tools software

The SIMATIC IPC PDT software installs the "IPC Configuration Center" and, optionally, the "IFP Ethernet Monitor" software.

The existing hardware components are automatically detected by the associated software.

The most important features of the software are:

- Dialog-guided installation
- Configuration via the IPC Configuration Center of:
 - Brightness
 - Screen saver
 - Tools
 - Touch settings
 - Ethernet Monitor settings

All other functions are described in the IPC Panel Driver and Tools operating manual.

Extended device functions

5.1 Monitoring Functions

5.1.1 Overview of the monitoring functions

The basic version of the device also provides monitoring functions. The following display, monitoring and control functions are available when the appropriate software is used:

- Temperature monitoring (over-/undertemperature)
- Battery monitoring: The state of the lithium battery is monitored.
- Monitoring of hard disks, memory cards and SSD drives with S.M.A.R.T. functionality
- Watchdog: Hardware or software reset of the computer
- Operating hours counter (information on the cumulative run time)
- Hard disk status

SIMATIC IPC DiagBase software

With the SIMATIC IPC DiagBase software included in the scope of delivery, use these functions for local monitoring. Use the "DiagBase Management Explorer" application to obtain a clear overview of the controls. Use the DiagBase Alarm Manager to receive notifications about individual alarms.

Note

For more information on SIMATIC IPC DiagBase software functionality, please refer to the relevant Online Help.

SIMATIC IPC DiagMonitor software

The SIMATIC IPC DiagMonitor software can be ordered as an accessory (not included in the scope of delivery). The CD contains both the monitoring software and the software for the stations to be monitored. The interface specifications and a library for creating your own applications are also provided.

5.1.2 Temperature monitoring/display

The temperature is recorded by means of three temperature sensors. The sensors monitor the processor temperature and the temperature in the area of the RAM module and the motherboard at the display port sockets.

The following fault reaction is triggered if one of the three temperature values exceeds the set thermal threshold:

Reaction	Option
Alarm window of the DiagBase or DiagMonitor software alerts the user.	None

The temperature error is saved until the temperatures have fallen below the thresholds and it is reset by one of the following measures:

- Acknowledgment of the error message by the user with DiagBase or DiagMonitor software
- Restart of the device

5.1.3 Watchdog (WD)

Configuration

You configure the watchdog with the DiagBase or DiagMonitor software.

Function

The watchdog is able to monitor system runtime and informs the user about the different reactions that are triggered if the system does not respond to the watchdog within the specified monitoring time.

A watchdog alarm is retained after a restart and is only reset and logged by the DiagBase or DiagMonitor software. The watchdog configuration is retained in the process.

Watchdog reactions

The following reactions can occur if the watchdog is not addressed within the set time:

Option	Reaction
Reset on	Executes a hardware reset when the watchdog expires
Reset off	Executes no action when the watchdog expires
Restart	Restarts the operating system when the watchdog expires
Shutdown	Shuts down the operating system when the watchdog expires

NOTICE

"Reset on" option

The "Reset on" option immediately triggers a hardware reset that may result in loss of data under Windows and damage to the installation.

Watchdog monitoring times

The monitoring time can be configured with the DiagBase or DiagMonitor software.

Note

When you change the monitoring time, the change becomes effective immediately.

5.1.4 Battery monitoring

The installed backup battery has a service life of 5 years. The status can be checked with two-tier battery monitoring. The information can be read via an I/O register and evaluated by the DiagBase or DiagMonitor software.

When the first warning threshold is reached, the remaining service life of the battery for buffering time and CMOS data is at least 1 month.

5.1.5 Mass storage monitoring

The state of HDD, SSD and CFast cards is monitored via SMART bit and reported by DiagBase or DiagMonitor.

5.2 Unified Write Filter (UWF)

The Unified Write Filter is a configurable write filter that makes it possible to assign write-protection to data storage media, such as hard disks, CFast cards, SSDs, internal USB drives, or external SATA drives.

External removable data storage media such as USB sticks and other flash drives, which are recognized by the operating system as a removable data storage medium, are not supported.

UWF combines the advantages of older write filters such as EWF and FBWF. It prevents all write access to protected media and transfers the data to buffer memory (overlay). This increases the reliability and stability of the system as well as the service life of write-sensitive media such as SSDs and CFast cards.

Note

UWF is disabled in the delivery state.

Note that memory is reduced when UWF is enabled.

NOTICE

Risk of data loss with enabled UWF

When UWF is enabled, all changes made to storage media with a UWF write protection after booting can be lost when the device is shut down. Proceed as follows to prevent this situation:
--

- | |
|--|
| <ul style="list-style-type: none">• Make changes to storage media only when UWF is disabled. |
|--|

See also

SIMATIC IPC Windows 10 User Manual
(<https://support.industry.siemens.com/cs/ww/de/view/109749498/en?dl=en>)

5.3 Enhanced Write Filter (EWF)

Purpose and function

The Enhanced Write Filter (EWF) is a function that is only available for Windows Embedded operating systems. EWF is a write filter that can be configured by the user.

You can use the Enhanced Write Filter to boot Windows Embedded Standard from read-only media, for example, memory cards or Solid State Drives (SSD), or provide individual partitions with write protection.

EWF can be used to minimize write access to storage media. This is important because the write cycles are limited due to technical reasons. We therefore recommend using EWF if you work with these storage media.

If you use HORM or compressed NTFS, EWF is indispensable.

 CAUTION
--

Data loss with several write filters

Both EWF and FBWF are preinstalled in the SIMATIC IPC images. If several writer filters are active on one partition at the same time, you may experience data loss. This may damage the machine or plant.

Make sure that you only activate one write filter for each partition.

Note

Windows Embedded Standard

The Enhanced Write Filter is deactivated in the Windows Embedded Standard default state.

- Back up your data after installation of the operating system and programs.
 - Activate the EWF.
-

Setting EWF

The following programs can be used to install, enable or disable the EWF:

- EWFMgr.EXE
- SIMATIC IPC EWF Manager.

The SIMATIC IPC EWF Manager is preinstalled and included on the supplied USB stick (DocuAndDrivers\Drivers).

Start the SIMATIC IPC EWF Manager as follows:

- "Start > All Programs > Siemens Automation > SIMATIC > EWF Manager > EWF Manager"

Configure the SIMATIC IPC EWF Manager as follows:

- "Start > All Programs > Siemens Automation > SIMATIC > EWF Manager > EWF Settings"

or

- Click the "SIMATIC IPC EWF Manager" icon in the system tray.

The following functions are available:

Function	Command
Write-protect drive C: Power on	<code>ewfmgr c: -enable</code>
Write-protect drive C: disable: the modified data are applied	<code>ewfmgr c: -commitanddisable</code>
Modified data on drive C: apply	<code>ewfmgr c: -commit</code>
Display information about the EWF drive	<code>ewfmgr c:</code>
Display help	<code>ewfmgr /h</code>

Note

The EWF commands affecting the write protection do not become active until after the next booting process.

Note

The EWF command `ewfmgr c: -commitanddisable` may not be used with the option `-live`.

Special notes for use

If EWF is enabled, when the PC shuts down all changes made on drive C: after the boot process are lost.

These changes are only retained on the PC in the following cases:

- EWF is disabled when you make changes.
- EWF is enabled and you save the changes before shutting down the device using the following command on C: drive :

```
ewfmgr c: -commit
```

Note

When the system is set to automatically adjust the clock for daylight saving time adjustment, systems without central time management and with activated EWF set the clock forward or backward by one hour in the daylight saving time or standard time period each time the system boots.

The reason for this behavior is that Windows Embedded Standard 7 makes a registry entry that the changeover to daylight saving time has occurred. Since this file is also protected against modification by the EWF, the marker is lost during the boot sequence and the adjustment is made again.

We therefore recommend that you deactivate the automatic adjustment and change the clock manually.

Follow these steps:

1. Deactivate automatic adjustment in the Control Panel: In the "Time Zone" tab opened with the menu command "Start > Control Panel > Date and Time", remove the check mark from the "Automatically adjust clock for daylight saving changes" check box.
 2. Save the change you have made with `ewfmgr c: -commit` and then reboot the system.
-

5.4 File Based Write Filter (FBWF)

Purpose and function

With the Embedded Standard 7, Microsoft introduced a second write filter, the File Based Write Filter (FBWF).

In contrast to EWF, which protects partitions based on sectors, FBWF works on the file level. When FBWF is enabled, all files and folders of a partition are protected unless they are included in an exception list.

FBWF is disabled by factory default in the operating system images for SIMATIC IPC and must be enabled and configured by the user.

When you enable FBWF, the folders C:\FBWF and D:\FBWF are authorized for writing by default.

Comparison between EWF and FBWF

- You should prefer FBWF, because it is more flexible in its configuration and allows immediate writing without rebooting.
- If you use HORM or compressed NTFS, EWF is indispensable.

 **CAUTION**

Data loss with several write filters

Both EWF and FBWF are preinstalled in the SIMATIC IPC images. If several writer filters are active on one partition at the same time, you may experience data loss. This may damage the machine or plant.

Make sure that you only activate one write filter for each partition.

Configuring FBWF

FBWF can be configured in command console using the program FBWFMGR.EXE.

Note

- Observe the following syntax: Enter a **space** after the drive designation colon.
 - Changes for direct write access only take effect after rebooting.
 - Only existing files and folders can be entered in the exception list.
-

Function	Command
Display the current FBWF status	<code>fbwfmgr /displayconfig</code>
Enable FBWF after the next startup	<code>fbwfmgr /enable</code>
Write to protected files	<code>fbwfmgr /commit c: \Test.txt</code>
Adding/removing elements in the exception list:	
• Add file	<code>fbwfmgr /addexclusion C: \Test.txt</code>
• Add folder	<code>fbwfmgr /addexclusion C: \Test folder</code>
• Remove file	<code>fbwfmgr /removeexclusion C: \Test.txt</code>
• Remove folder	<code>fbwfmgr /removeexclusion C: \Test folder</code>
Call up the help function	<code>fbwfmgr /?</code>

Detailed instructions on FBWF are available on the Internet ([http://msdn.microsoft.com/en-us/library/aa940926\(WinEmbedded.5\).aspx](http://msdn.microsoft.com/en-us/library/aa940926(WinEmbedded.5).aspx)).

5.5 Buffer memory NVRAM

Depending on the configuration ordered, the motherboard is equipped with an NVRAM that applications can use to back up data in the event of a power failure.

Failure of the supply voltage for a duration longer than 5 ms is indicated by the DC FAIL signal.

Depending on the system utilization, up to 512 KB can be saved in the NVRAM.

A memory window with a maximum size of 512 KB can be displayed by means of PCI address register. The base address is initialized by the BIOS.

A corresponding function is implemented there for using the NVRAM under WinAC RTX and for using the CPU150xS SW controller.

5.6 Operation without monitor and keyboard

The device can be operated without a monitor and keyboard. The device startup is guaranteed without these peripherals. A USB keyboard and mouse and a monitor can be connected later for diagnostics.

A digital DVI monitor or DisplayPort monitor cannot be activated retrospectively unless the Windows Embedded Standard or Windows 7 or Windows 10 Ultimate operating system has completed booting.

5.7 Active Management Technology (AMT)

AMT (Active Management Technology) is technology for the remote maintenance of computers (simply called AMT-PC in the remainder of the document) and it includes the following functions:

- Keyboard Video Mouse(KVM) Redirection: Using KVM that is integrated in the AMT hardware you access the AMT PC remotely. With KVM, you can also control AMT PCs that have no operating system or a defective operating system. A KVM remote session is always possible with the KVM server integrated in the firmware. This means you can restart the PC and change the BIOS setup remotely.
- Remote power management: AMT PCs can be turned on and off and restarted from another PC.
- SOL (Serial over LAN): Redirection of the data of a serial interface to the network. The main use of the function is text-based remote control of an AMT PC using a console.
- IDE redirection: An ISO file on the help desk PC can be mounted on the AMT PC and used as a DVD drive.

An ISO file contains a memory image of the content of a CD or DVD structured in the ISO 9660 format.

- Remote reboot: An AMT PC can be booted from a bootable ISO file made available by another PC.

SIMATIC IPC Remote Manager

The "SIMATIC IPC Remote Manager" software is available for utilization of the AMT functions with SIMATIC IPCs. The software can be ordered from the Siemens online ordering system. For detailed information about "SIMATIC IPC Remote Manager", refer to the corresponding product documentation: SIMATIC IPC Remote Manager (<http://support.automation.siemens.com/WW/view/en/48707158>)

Typical areas of application and functions of the SIMATIC IPC Remote Manager:

- Remote maintenance of SIMATIC IPC with AMT, for example for service purposes in the case of a defective operating system or for adapting BIOS settings.
- Diagnostics without on-site use
- Convenient service: Access to AMT clients, such as headless systems, without additional hardware
- Resource management

Requirement

- A device with Xeon or Core i5 processor
- A functioning and configured management engine
- A functioning and configured Ethernet connection
- A help desk PC with a functioning and configured Ethernet connection for the full AMT functionality

Configuration of the AMT PC

You configure AMT by means of the BIOS setup and MEBx (Management Engine BIOS Extension). MEBx is a BIOS extension for configuration of AMT (see BIOS description in section "Technical specifications").

5.8 Trusted Platform Modul (TPM)

Depending on the ordered configuration, the motherboard contains a Trusted Platform Module (TPM). A TPM is a chip that adds important security functions to your device, such as enhanced protection of the PC against unauthorized manipulation by third parties. The current operating systems, for example, Windows 7 or Windows 10, support these security functions.

NOTICE
Import restrictions
TPM technology is subject to legal restrictions in some regions and may not be used there. You could commit a crime by importing or exporting the device in certain countries.
Note the respective import provisions for the TPM module.

Activating the Trusted Platform Module

The TPM can be activated under "Security" in the BIOS setup. Please follow the instructions in the BIOS setup.

Using the Trusted Platform Module

The TPM can be used in Windows with the "BitLocker" drive encrypter.

The Windows operating system is installed in UEFI mode in the delivery state for this purpose. It is not possible to use BitLocker under Window Embedded operating systems as these are installed in MBR mode.

To use BitLocker, follow the relevant instructions in the operating system.

Note**Risk of data loss**

If you lose the password for the drive encryption, you will not be able to restore the data. You will then lose access to the encrypted drive.

The warranty does not cover a reset of the hardware in the event of a loss of a password.

Please store the password carefully and make sure it is protected against unauthorized access.

Expanding and assigning parameters to the device

6.1 Installing and removing the memory module

6.1.1 Opening the device

Note

Work on the open device may only be carried out by authorized and qualified personnel. Within the warranty period, you may only expand the hardware with memory and expansion cards.

NOTICE**The device contains electronic components that may be destroyed by ESD**

You therefore need to take precautionary measures before you open the device. Please refer to the ESD Directives on handling electrostatic-sensitive components in ESD guideline (Page 98).

Requirement

- The device is disconnected from the power supply.
- 1 T10 screwdriver

Procedure

Opening the device

1. Remove the marked screws.



2. Remove the two indicated central screws and loosen the two outer screws slightly.



3. Remove the marked screws.



4. Lift off the front cover by about 2 to 3 cm.



5. Remove the backup battery from its guide in the front panel.



Observe the information in section "Installing and removing the backup battery (Page 76)".

6. Put down the front panel.

Closing the device

Proceed in reverse order.

6.1.2 Opening the device containing expansion cards

Note

Work on the open device may only be carried out by authorized and qualified personnel. Within the warranty period, you may only expand the hardware with memory and expansion cards.

NOTICE

The device contains electronic components that may be destroyed by ESD

You therefore need to take precautionary measures before you open the device. Please refer to the ESD Directives on handling electrostatic-sensitive components in ESD guideline (Page 98).

Requirement

- The device is disconnected from the power supply.
- 1 T10 screwdriver

Procedure

Opening the device

1. Remove the marked screws.
2. Lift off the front panel in the direction of the arrow
3. Put down the front panel.

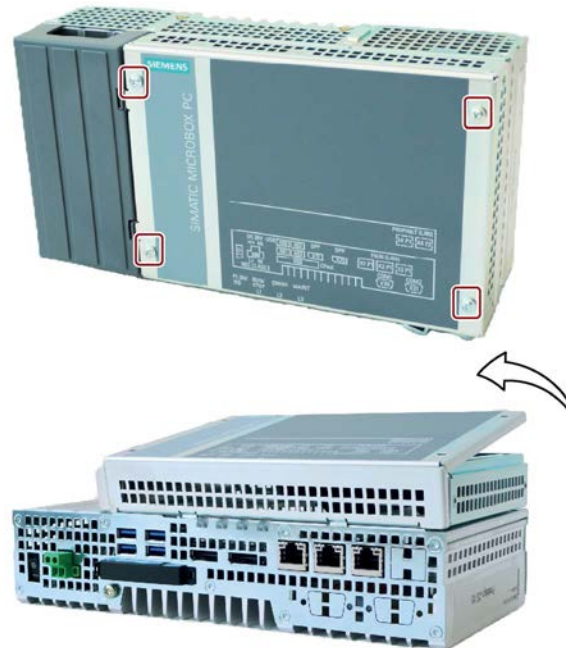

Closing the device

Proceed in reverse order.

6.1.3 Replacing memory modules

The motherboard is equipped with one slot for an SO-DIMM DDR4 memory module. You can use it to expand the memory capacity of the device to a maximum of 16 GB.

Note

Use only the memory modules recommended by Siemens AG.

Requirement

- The device is disconnected from the power supply.
- The device is open (see sections "Opening the device (Page 61)" and "Opening the device containing expansion cards (Page 63)").

Procedure

Note

Observe the directives on handling electrostatic-sensitive components in ESD guideline (Page 98).

Removal

1. Push down the module clips towards the outside.
The memory module tilts forward.
2. Remove the memory module from the slot.



Installation

1. Insert the memory module into the marked slot at an incline with the contact side facing the motherboard.
2. Carefully press the memory module into the contact strip until the latches engage.



The new memory configuration is detected automatically. The memory configuration is displayed in the main BIOS Setup menu under "Total Memory".

After insertion and removal

Close the device.

The new memory capacity will be automatically detected and displayed in the BIOS setup when the device is switched on.

6.2 Installing and removing CFast cards

The device has a slot for a CFast card on the side with the interfaces. Always use SIMATIC IPC CFast cards for industrial applications.

NOTICE

Damage to the device

The CFast and CompactFlash connections are not compatible.

Use the slot described here only for a CFast card; otherwise, the device will be damaged.



Requirement

- The device is switched off.
- SIMATIC IPC CFast card that is approved for industrial applications.

Procedure

Installation

NOTICE

Inserting a memory card

If you are using the memory card in a device installed in a system, you must observe the safety regulations for work on electrical systems.

Insert the CFast card into the slot, working carefully and without applying excess force.

1. Release the lock of the cover.
Push against the cover in the direction indicated. Open the cover completely.

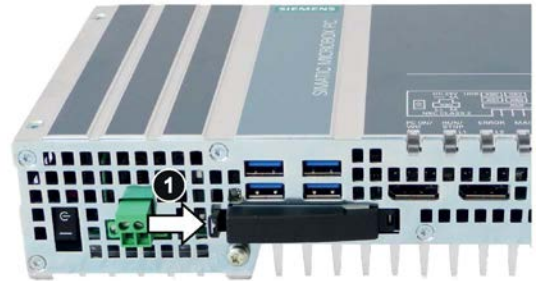

2. Insert the CFast card into the slot as shown in the figure.
Push CFast card into the slot until it snaps into place.

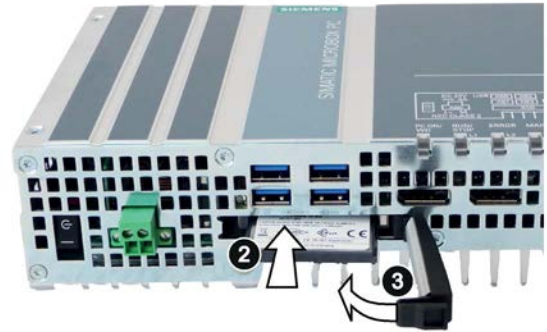

3. Close and lock the cover.

Removal

Remove the CFast card from the memory slot by pushing it in until it is ejected by about 5 mm.

Proceed in reverse order.

6.3 Installing and removing PCIe cards

WARNING

Risk of fire through expansion cards

Expansion cards generate additional heat. The device may overheat and cause a fire.

Please note the following:

- Observe the safety and installation instructions for the expansion cards.
- If in doubt, install the device in an enclosure that is compliant with requirements to sections 4.6 and 4.7.3 of the EN 60950-1:2006 and IEC/UL/EN/DIN-EN 60950-1 standards.

NOTICE

Points to note with expansion cards

Expansion cards may impose restrictions on the installation location (fire-proof enclosure) and permitted mounting positions (see Technical specifications (Page 105)). If the device has been fitted with expansion cards, please observe the safety and installation instructions for the expansion cards in the corresponding documentation.

If in doubt, install the device in an enclosure that is compliant with IEC/UL/EN/DIN-EN 60950-1, sections 4.6 and 4.7.3.

NOTICE

Ambient conditions when using PCIe cards:

Please observe the conditions of use regarding the ambient temperature when using PCIe cards.

The temperature in the PCIe slot of the IPC is around 15 K higher than the ambient temperature. This means the maximum permissible ambient temperature may be lower than for the IPC427E alone.



Figure 6-1 Device version with one PCIe slot



Figure 6-2 Device version with two PCIe slots

Requirement

- The device is disconnected from the power supply.
- The device is open (see section "Opening the device containing expansion cards (Page 63)").
- Blanking plates: If the PCIe card to be used has external interfaces, you can use these blanking plates to install the connectors. You can also use a slot plate with connector perforations.
- 1 T10 screwdriver

Procedure

Installation

Note

Observe the guidelines for handling electrostatic-sensitive components in section "ESD guideline (Page 98)".

6.3 Installing and removing PCIe cards

1. Remove the screw in the blanking plate for the slot you require and remove the blanking plate.



2. Remove the retainer.

3. Insert the expansion card into the slot as shown.

Secure the expansion card with the corresponding screw.



4. Slide the clamp in the direction indicated.

Secure the bracket with the designated screw.



5. Close the device as specified in section "Opening the device containing expansion cards (Page 63)".

Removal

Proceed in reverse order.

Configuring BIOS setup

You may need to make settings in the BIOS Setup. For detailed information about installation, please refer to the documentation provided with the specific expansion card.

6.4 Assigning CPU power consumption parameters

The CPU can be switched to one of the following modes via a BIOS Setup setting (BIOS setup > Menu "Power" > "Power&Performance" > "CPU Power Management Control" > "CPU Power Level"):

Operating mode	Description
Standard	Default setting The CPU clock is dynamically limited with maximum 3D graphics performance. The maximum CPU power consumption is 17 W.
Performance optimized	Setting the high performance for CPU and Graphics at the same time. The maximum CPU power consumption is 25 W.
Determinism optimized	Same as standard, but additionally optimized for deterministic operation with constant CPU frequency.
Temperature optimized	Setting for lowest power consumption. The CPU clock is limited at a higher load. The maximum power consumption of the CPU is 12 W.

Device maintenance and repair

7.1 Maintenance

To maintain high system availability, we recommend that you replace PC components that are subject to wear, at the intervals for replacement indicated in the table below.

Component	Replacement interval
Hard disk drive	3 years
CMOS backup battery	4 years

7.2 Repair information

Making repairs

Install only system expansions approved for this device. If you install other expansion devices, you may damage the device or violate the safety requirements and regulations on RF suppression. Contact your technical support team or where you purchased your PC to find out which system expansion devices may safely be installed.

 WARNING
<p>Opening the device</p> <p>Unauthorized opening and improper repairs on the device may result in substantial damage to equipment or endanger the user. If you install or replace a system expansion and damage your device, the warranty will become void.</p> <p>The device may only be repaired by qualified personnel.</p>

Safety when working in and on electrical systems

Work in or on electrical systems may only be carried out by authorized persons. The following safety regulations apply in Germany for the prevention of electric shock and electrocution:

1. Switch off the system
2. Secure the system to prevent it switching back on
3. Check the system to ensure it is de-energized
4. Ground and short the system
5. Cover or shield adjacent live parts

These safety rules are based on the DIN VDE 0105 standard.

Note

These safety steps must always be taken in the above order before any work on electrical systems. Once work on an electrical system is finished, cancel the safety steps starting with the last and finishing with the first.

In accordance with the applicable safety regulations, clearly indicate on an electrical system that work on it is underway.

Observe the safety regulations applicable in the country of operation.

NOTICE

Electrostatic-sensitive components

The device contains electronic components which are destroyed by electrostatic charges. This can result in malfunctions and damage to the machine or plant.

Make sure you take precautionary measures even when you open the device, for example, when opening device doors, device covers or the housing cover. For more information, refer to the section "ESD Guideline (Page 98)"

 WARNING
--

Risk of explosion and release of harmful substances
--

Improper handling of lithium batteries can result in an explosion of the batteries. Explosion of the batteries and the released pollutants can cause severe physical injury.
--

Observe all safety and handling instructions for lithium batteries. Do not expose lithium batteries to flames and do not solder the battery cell. Do not recharge, open, or short lithium batteries. Do not reverse lithium battery polarity or heat the batteries to over 100°C. Keep lithium batteries out of direct sunlight and protect them from moisture and condensation.
--

NOTICE

Batteries and rechargeables pollute the environment

Do not dispose of used batteries or rechargeables in household waste. Users are obliged by law to return used batteries and rechargeable batteries. You as the user are legally responsible disposing used batteries or rechargeables in a correct manner.

Observe the following rules for the disposal of batteries and rechargeables:

- Dispose of used batteries and rechargeable batteries separately as hazardous waste in accordance with local regulations.
- You can take used batteries and rechargeable batteries to public collection points and wherever batteries and rechargeable batteries of the type in question are sold.
- Mark used battery containers as "Used batteries".

Limitation of liability

All technical specifications and approvals for the device apply only if you use expansion components that have a valid CE approval (CE marking). The installation instructions for expansion components in the associated documentation must be observed.

UL approval of the device only applies when the UL-approved components are used according to their "Conditions of Acceptability".

We are not liable for functional limitations caused by the use of third-party devices or components.

See also

Spare parts and repairs (<http://support.automation.siemens.com/WW/view/en/16611927>)

7.3 Installing and removing hardware

7.3.1 Installing and removing the backup battery

The service life of a backup battery is approximately 5 to 8 years, depending on the operating conditions.

Note

An empty backup battery impairs the function of the device. Replace the backup battery in good time.

Replace the backup battery only with a battery of the same type or a type recommended by Siemens.

The article number of the backup battery is A5E34734290.

Dispose of used batteries in accordance with local regulations.

Requirement

- The device is disconnected from the power supply.
- No peripherals such as a mouse, keyboard or monitor are connected.
- 1 T10 screwdriver

Procedure - Removal

NOTICE

Date and time setting are lost

The time setting is cleared if it takes more than 30 seconds to replace the battery. The device time is no longer synchronized. Timer-controlled programs will no longer run or run at the incorrect time. This may damage the plant.

Set the device time again.

1. Remove the indicated screws, pull the cover panel in direction of the arrow and lift it off.



2. Carefully remove the connector.



3. Remove the battery holder from the enclosure guide.



4. Remove the battery from the battery holder.



Procedure - Installation

Install the device by following the same steps in the reverse order.

7.3.2 Changing storage media

7.3.2.1 Replacing a HDD/SSD

This procedure applies to the replacement of the built-in HDD or SSD.

Requirement

- The device is disconnected from the power supply.
- The device is removed.
- 1 T10 screwdriver

Procedure

Note

Observe the guidelines for handling electrostatic-sensitive components in section "ESD guideline (Page 98)".

Removal

1. Remove the wall mounting bracket or the vertical mounting bracket, if any, and then the indicated screws.
Push the cover in the direction indicated and lift it off.
2. Remove the marked screws.
These screws secure the HDD/SSD.



3. Remove the HDD/SSD from the enclosure.

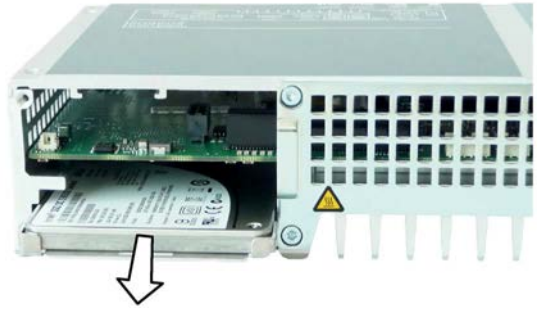

4. Loosen the HDD/SSD on the side from the base plate as shown.

The HDD/SSD is retained on the base plate by means of the studs shown. An additional insulating film is inserted into the base plate for HDD operation.



Installation

1. Place the HDD/SSD onto the base plate.
Observe the recess position shown when installing an SSD. The SSD interfaces should be located opposite the recess.



2. Insert the new HDD/SSD into the enclosure.

Take care that the nameplate is on top. Slide the HDD/SSD into the enclosure until you can see the mounting holes.



3. Turn in the marked screws.



4. Insert the cover into the enclosure.
Turn in the marked screws.



7.4 Installing the software

7.4.1 Reinstalling the operating system

Note

Further information on the delivered operating system can be found on the USB stick provided.

7.4.1.1 General installation procedure

If the supplied operating system is no longer functioning correctly, you can reinstall it from the supplied USB stick:

- Using the Recovery function of the USB stick
- Using the Restore function of the USB stick

For these functions, set up the USB stick as bootable. To boot from the USB stick, "USB Boot" must be set to "enabled" in the BIOS Setup.

Note**Installing the operating system in UEFI mode**

To install an operating system in UEFI mode, the USB stick must also be booted in UEFI mode. Since Windows Embedded operating systems are installed in MBR mode, the USB stick boots automatically for the Restore function in MBR mode (Legacy mode).

Note**GPT partitioning with Windows 10**

Please note that GPT partitioning should be selected for Windows 10 (GPT: GUID Partition Table).

Recovery function (only with Windows 7 Ultimate and Windows 10)

NOTICE
Windows Embedded
The Recovery function is not available for Windows Embedded operating systems.

The supplied USB contains the installation program with tools for configuring the drives and installing the operating system with the supported languages.

The basic language of the installed operating system is English. To add other languages, install these languages from the supplied USB stick ("Language packs" directory).

Contents of the "DocuAndDrivers" directory

The supplied USB stick contains the documentation, hardware drivers and updates.

In Windows, these contents are available via a menu.

Restore function

If you have ordered IPC427E with operating system, the supplied USB stick contains the Restore function.

7.4.1.2 Restoring the factory state

You can restore the original factory software using the Restore function. The USB stick contains the necessary images and tools for transferring the factory software to the hard disk/SSD or memory card of your PC. The following options are available for restoring software:

- Restore the entire hard disk / SSD or memory card with drive C: (system) and drive D: Use the "Restore entire hard disk" option.
- Restore drive C: only This allows you to retain any user data on drive D: Use the "Restore system partition only" option.

NOTICE

Data are deleted

When you select the "Restore entire hard disk" option, all data, user settings and authorizations or license keys on the hard disk are lost. The hard disk is reset to the delivery state with partitions "C:" and "D:".

If the "Restore system partition only" option is set, all files on drive C: (System) are deleted. All data, user settings and existing authorizations or license keys on drive "C:" will be lost. Drive "C:" on the hard drive is completely erased, reformatted and the original software is written to it.

Procedure

Note

The "USB Boot" option has to be set to "Enabled" in the BIOS menu "Boot" so that the device can boot from the USB stick.

1. Connect the USB stick to the device.
2. Restart the device.
3. Press <ESC> when the following BIOS message appears:

```
Press Esc for Boot Options
```

The BIOS selection menu is displayed when initialization is completed.

4. To boot from the USB stick, select the Boot Manager.
5. Select the USB stick in the Boot Manager and confirm the entry.
6. Select the Restore function and confirm the entry.
7. Follow the on-screen instructions.

7.4.1.3 Windows 7 / Windows 10

Installing Windows

Note

Windows 10

Specific information on using the Windows operating systems is available in the following manuals (not included in the scope of delivery):

- Windows 10 - Step by Step (MS Press No. 324)
 - Windows 10 Plain and Simple (MS Press No. 422)
 - Windows 10 Inside Out (MS Press No. 325 / MS Press No. 418)
-

Note

Windows 7

Specific information on using the Windows operating systems is available in the following manual (not included in the product package): Microsoft Windows 7 - Technical Reference (MS Press No. 5927).

Requirement

- USB keyboard and monitor
- Supplied USB stick with Recovery function

Procedure

Note

The "USB Boot" option has to be set to "Enabled" in the BIOS menu "Boot" so that the device can boot from the USB stick.

1. Connect the USB stick to the device.
2. Restart the device.
3. Press <ESC> when the following BIOS message appears:

`Press Esc for Boot Options`

The BIOS selection menu is displayed when initialization is completed.

4. To boot from the USB stick, select the Boot Manager.
5. Select the USB stick in the Boot Manager and confirm the entry.
6. Select the Recovery function and confirm the entry.

7. Follow the on-screen instructions.

After a few seconds, you will see the "Install Windows" installation program.

NOTICE**Data deleted**

All data, user settings and existing authorizations or license keys are deleted during the installation of Windows 7 and Windows 10.

- Back up all data.
- Check the data and time in the BIOS setup, "Main" menu and correct the displayed time if necessary.

8. Now follow the instructions of the installation program "Install Windows". You will find additional information in the operating system manual.

"Install Windows" installation program

The language of the installation program and the operating system you want to install has been preset to English. You can change the language of the operating system after the installation. You can find information on this in section: "Setting up the language selection by means of the Multilanguage User Interface (MUI) (Page 85)".

Setting up partitions under Windows

You can set up partitions during the installation process.

The recommended minimum size for Windows system partition varies, depending on the amount of RAM and additional software that you are going to use. Information about the partitioning of the data volume in the delivery state is available in section Setting up the partitions under Windows 7 Ultimate and Windows 10 (Page 90).

Setting up the language selection by means of the Multilanguage User Interface (MUI)

You can set the display of menus, dialogs or other information, such as date and time, to a different language. For this purpose, you can either select one of the preinstalled languages or install a new language package.

The following command sequences are described in English. Depending on the default setting, they can be displayed in another language.

Setting up language selection

Changing the settings for language, region and formats of a registered user account

1. Choose:
"Start > Control Panel > Clock, Language, and Region > Regional and Language Options"
2. You can make the desired changes in the "Formats", "Location" and "Keyboards and Languages" tabs.

Changing the settings for language, region and formats of the system account and the standard user account

You can change the settings for language, region and formats of the system account (for example, the language in the user login dialog) and the settings of the standard user account (standard setting for new users). The settings of the registered user are copied to the system account and the standard user account for this purpose.

1. Choose:
"Start > Control Panel > Clock, Language, and Region > Regional and Language Options"
2. You can make the required changes in the "Administrative" tab. You copy the settings by clicking the respective button.

Installing new language packages

Some language packages are available on the Recovery section of the USB stick in the "Language packs" folder.

1. Choose:
"Start > Control Panel > Clock, Language, and Region > Regional and Language Options"
2. Select the "Keyboards and Languages" tab.
3. Click the "Install/uninstall languages" button and make the required changes.

The following languages can be installed at a later time:

Language	Windows 7 / 10
German	X
English	X
French	X
Italian	X
Spanish	X
Chinese (Hong Kong)	X
Chinese (simplified)	X
Chinese (Taiwan)	X
Japanese	X
Russian	X

7.4.1.4 Windows Embedded Standard

General installation procedure

If your software becomes corrupt for any reason, you can reinstall it using the supplied USB stick. The USB stick contains an image file for the device memory with the original software package (operating system with installed hardware drivers).

Note

You require a USB keyboard, a monitor and the supplied USB stick to reinstall the operating system. Before performing the new installation, you should check the date and time set in the BIOS Setup, "Main" menu, and correct these if necessary.

To be able to use the Enhanced Write Filter (EWF), the operating system must be installed in MBR mode.

Language selection in Windows Embedded Standard 7

You can change the language using the supplied USB stick. The USB stick contains the required language packages and help for changing the system language.

Note**Note the license terms of Windows Embedded Standard 7**

Note the license terms for Windows Embedded Standard 7 and especially the extended software terms of the Siemens AG.

You can find the license terms in the delivered document "MICROSOFT SOFTWARE LICENSE TERMS for Windows Embedded Standard 7" and in the system drive under \Windows\System32\license.rtf.

Procedure - Change system language

1. Connect the supplied USB stick to a free USB port of the device.
2. Restart the device and press "ESC" to access the BIOS.
3. Switch to the "Boot" menu and select the setting "USB Boot" = "Enabled".
4. Switch to the "Exit" menu and select "Exit Saving Changes".
5. Restart the device and press the "ESC" key and then enter the "Boot Manager" menu.
6. In the "Legacy USB" area, select the boot menu of the USB stick and press "Enter" to boot from this.
7. Follow the instructions on the screen.
8. After selecting the menu dialog language, select the menu entry "Manage language packages".

Depending on the current language setup, you have the following options in the "Manage language packages" menu:

- Display language settings
- Install language
- Change language
- Uninstall installed language

7.4.2 Partitioning the data storage medium

7.4.2.1 Partitioning in Windows Embedded Standard 7

You will need to reconfigure the partitions after installing a new drive, to repair corrupt partitions or to change the partitioning.

Partitioning of the SIMATIC IPC CFast card

The SIMATIC IPC CFast card for Windows Embedded Standard 7 comes configured with the following default partitions:

Table 7- 1 32-bit versions of the operating system

Partition	Name	Size of the card			File system
		8 GB	16 GB	30 GB	
First	SYSTEM	6 GB	12 GB	25 GB	NTFS not compressed
Second	DATA	Remainder	Remainder	Remainder	NTFS not compressed

* Due to partitioning/formatting, the actual CFast capacity does not correspond to the memory size specified on the SIMATIC IPC CFast card.

Table 7- 2 64-bit versions of the operating system

Partition	Name	Size of the card		File system
		16 GB	30 GB	
First	SYSTEM	13 GB	25 GB	NTFS compressed
Second	DATA	Remainder	Remainder	NTFS compressed

* Due to partitioning/formatting, the actual CFast capacity does not correspond to the memory size specified on the SIMATIC IPC CFast card.

Partitioning of the HDD or SSD

In the delivery state, the following partitions are configured on the HDD or SSD drive with the Windows Embedded Standard 7 operating system:

Table 7- 3 Size of the HDD/SSD

Partition	Name	Partition size		File system
		< 100 GB	> 100 GB	
First	System	60 GB	100 GB	NTFS not compressed
Second	Data	Remainder	Remainder	NTFS not compressed

To restore the partitions to their original delivery state, we recommend the software **SIMATIC IPC Image & Partition Creator**. Additional information is available in the accompanying documentation.

7.4.2.2 Setting up the partitions under Windows 7 Ultimate and Windows 10

You will need to reconfigure the partitions after installing a new drive, to repair corrupt partitions or to change the partitioning.

Partitioning of the HDD or SSD

In the factory state, the following partitions are set up on the HDD or SSD for the Windows 7 x64 UEFI operating system:

Partition	Name	Partition size		File system
		SSD: > 60 GB	SSD/HDD: > 100 GB	
Primary	Boot	260 MB		FAT32
Second	MSR	128 MB		None
Third	System	60 GB	100 GB	NTFS, not compressed
Fourth	Data	Remainder		NTFS, not compressed

In the factory state, the following partitions are set up on the HDD or SSD for the Windows 10 UEFI operating system:

Partition	Name	Partition size		File system
		SSD: > 60 GB	SSD/HDD: > 100 GB	
First	Boot	260 MB		FAT32
Second	MSR	128 MB		None
Third	System	60 GB	100 GB	NTFS, not compressed
Fourth	WinRE	500 MB		NTFS, not compressed
Fifth	Data	Remainder		NTFS, not compressed

7.4.2.3 Adapting the partitions under Windows 7 Ultimate and Windows 10

With the disk management, you can adapt the partitioning of your drives.

You can reduce or delete an available partition to acquire unassigned memory space, which you can use to set up a new partition or to increase an existing partition.

NOTICE
Data lost in the case of deleting a partition!
If you delete a partition, all the data on this partition is lost.
Back up your data before you change partitions.

Requirement

You are logged on as an administrator.

Procedure - Reduce partition

A partition can only be reduced if sufficient space is available.

1. Click with the right mouse button on the partition to be reduced and click on "Reduce size".
2. Follow the instructions.

Procedure - Increase partition

Note

To increase a partition, this partition must not be formatted with a file system or the partition must be formatted with an "NTFS" file system.

1. Click in the partition manager with the right mouse button on the partition to be increased and click on "Increase size".
2. Follow the instructions on the screen.

Additional information is available in the "Help" menu under "Help topics" and "Search".

7.4.3 Installing drivers and software

Note

In the case of multilingual operating systems (MUI versions), you must set the menus and dialogs and the default language to English (US) in the regional settings before new drivers and operating system updates are installed.

You can install a second language package for service purposes at a later time with the supplied USB stick under Windows Embedded Standard 7.

Procedure

1. Connect the supplied USB stick to the USB port.
2. Start the program "START_DocuAndDrivers".
3. Select "Drivers" in the index.
4. Select the device and operating system.
5. Select the required driver.
6. Open the folder with the driver data by clicking on the link next to "Driver path".
7. Start the setup program in this folder.

Note

For a new installation of Windows operating systems, the chipset driver must be installed before all other drivers, if required.

7.4.4 Update installation

7.4.4.1 Updating the operating system

Windows

The latest updates for the Windows operating system are available on the Internet at Microsoft (<http://www.microsoft.com>) and on the device in the Start menu "Start > All Programs > Windows Update > Check for updates".

Note

Before you install new drivers or operating system updates for Windows MUI versions, configure the regional menu and dialog settings and the default English (US) language.

other operating systems

Contact the corresponding manufacturer.

7.4.4.2 Installing or updating application programs and drivers

Drivers for USB sticks are included in the operating system and do not have to be installed separately.

For information about installation of SIMATIC software packages, refer to the corresponding manufacturer documentation.

For updates of third-party drivers and application programs, contact the respective manufacturer.

7.4.5 Backing up data

We recommend the software tool **SIMATIC IPC Image & Partition Creator** (as of V3.4) to back up data under Windows. This tool provides convenient and efficient functions for backing up and restoring the full content of memory cards, hard disks and individual partitions (images).

The **SIMATIC IPC Image & Partition Creator** can be ordered using the Siemens online ordering system (<https://mall.industry.siemens.com>). For more information about SIMATIC IPC Image & Partition Creator, refer to its product documentation.

7.5 Recycling and disposal

The devices described in these operating instructions can be recycled thanks to their low level of pollutants. Contact a certified disposal service company for environmentally sound recycling and disposal of your old devices.

Technical specifications

8.1 Certificates and approvals

ISO 9001 certificate

The Siemens quality management system for our entire product creation process (development, production and sales) meets the requirements of ISO 9001:2008.

This has been certified by DQS (the German society for the certification of quality management systems).

Certificate no.: 001323 QM08

Software license agreements

If the device is supplied with preinstalled software, you must observe the corresponding license agreements.

UL approval



The following approvals are available for the device:

- Underwriters Laboratories (UL) in accordance with standard UL 60950-1 Second Edition (I.T.E.)
- Underwriters Laboratories (UL) in accordance with standard UL508 (IND.CONT.EQ)
- Canadian National Standard CAN/CSA-C22.2 No. 60950-1-07
- Canadian National Standard CAN/CSA-C22.2 No. 142

FCC (USA) and ICES (Canada) Compliance

USA	
Federal Communications Commission Radio Frequency Interference Statement	This equipment has been tested and found to comply with the limits for a Class A digital device, pursuant to Part 15 of the FCC Rules. These limits are designed to provide reasonable protection against harmful interference when the equipment is operated in a commercial environment. This equipment generates, uses, and can radiate radio frequency energy and, if not installed and used in accordance with the instruction manual, may cause harmful interference to radio communications. Operation of this equipment in a residential area is likely to cause harmful interference in which case the user will be required to correct the interference at his own expense.
Shielded Cables	Shielded cables must be used with this equipment to maintain compliance with FCC regulations.
Modifications	Changes or modifications not expressly approved by the manufacturer could void the user's authority to operate the equipment.
Conditions of Operations	This device complies with Part 15 of the FCC Rules. Operation is subject to the following two conditions: (1) this device may not cause harmful interference, and (2) this device must accept any interference received, including interference that may cause undesired operation.
CANADA	
Canadian Notice	This Class A digital apparatus complies with Canadian ICES-003 (B).
Avis Canadien	Cet appareil numérique de la classe A est conforme à la norme NMB-003 (B) du Canada.

RCM AUSTRALIA/NEW ZEALAND



This product meets the requirements of EN 61000-6-3 Generic standards - Emission standard for residential, commercial and light-industrial environments.

This product meets the requirements of the standard EN 61000-6-3 Generic standards - Emission standard for residential, commercial and light-industrial environments.

KOREA



This product meets the requirements of Korean certification.

This product satisfies the requirement of the Korean Certification (KC Mark).

이 기기는 업무용(A급) 전자파 적합기기로서 판매자 또는 사용자는 이 점을 주의하시기 바라며 가정 외의 지역에서 사용하는 것을 목적으로 합니다.

8.2 Declaration of conformity

8.2.1 CE marking



The device meets the guidelines listed in the following sections.

EU Declaration of Conformity

The associated declaration of conformity is available on the Internet at the following address:
EC Declaration of Conformity, UL approval Canada/USA
(<https://support.industry.siemens.com/cs/ww/en/ps/23703>).

8.2.2 Electromagnetic compatibility, Industrial and Residential Areas

Electromagnetic compatibility

This product meets the requirements of EC Directive 2014/30/EU "Electromagnetic Compatibility".

The device is designed for the following areas of application corresponding to the CE marking:

Scope of application	Requirements for	
	Interference emission	Immunity to interference
Industrial area	EN 61000-6-4	EN 61000-6-2
Residential and commercial areas and small businesses	EN 61000-6-3	EN 61000-6-1

RoHs directive

This product meets the requirements stated in the RoHS directive (Restriction of Hazardous Materials): 2011/65/EU

Compliance with the directive has been reviewed according to the following standard:
EN 50581

8.3 Directives and declarations

8.3.1 ESD guideline

What does ESD mean?

An electronic module is equipped with highly integrated components. Due to their design, electronic components are highly sensitive to overvoltage and thus to the discharge of static electricity. Such electronic components or modules are labeled as electrostatic sensitive devices.

The following abbreviations are commonly used for electrostatic sensitive devices:

- ESD – Electrostatic sensitive device
- ESD – Electrostatic Sensitive Device as a common international designation

Electrostatic sensitive devices can be labeled with an appropriate symbol.



NOTICE

Damage to ESD from touch

Electrostatic sensitive devices, ESD, can be destroyed by voltages which are far below the human perception limit. If you touch a component or electrical connections of a module without discharging any electrostatic energy, these voltages may arise.

The damage to a module by an overvoltage can often not be immediately detected and only becomes evident after an extended period of operation. The consequences are incalculable and range from unforeseeable malfunctions to a total failure of the machine or system.

Avoid touching components directly. Make sure that persons, the workstation and the packaging are properly grounded.

Charge

Every person without a conductive connection to the electrical potential of his/her surroundings can be electrostatically charged.

The material with which this person comes into contact is of particular significance. The figure shows the maximum electrostatic voltages with which a person is charged, depending on humidity and material. These values conform to the specifications of IEC 61000-4-2.

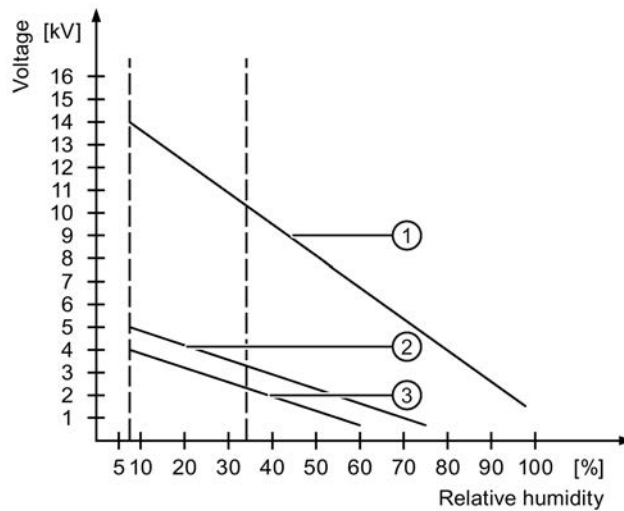

- ① Synthetic materials
- ② Wool
- ③ Antistatic materials such as wood or concrete

NOTICE

Grounding measures

There is no equipotential bonding without grounding. An electrostatic charge is not discharged and may damage the ESD.

Protect yourself against discharge of static electricity. When working with electrostatic sensitive devices, make sure that the person and the workplace are properly grounded.

Protective measures against discharge of static electricity

- Disconnect the power supply before you install or remove modules which are sensitive to ESD.
- Pay attention to good grounding:
 - When handling electrostatic sensitive devices, make sure that persons, the workstation and devices, tools and packaging used are properly grounded. This way you avoid static discharge.
- Avoid direct contact:
 - As a general rule, do not touch electrostatic sensitive devices, except in the case of unavoidable maintenance work.
 - Hold the modules at their edge so that you do not touch the connector pins or conductor paths. This way, the discharge energy does not reach and damage the sensitive components.
 - Discharge your body electrostatically before you take a measurement at a module. Do so by touching grounded metallic parts. Always use grounded measuring instruments.

8.4 Dimension drawings

8.4.1 Dimension drawing - mounting on a DIN rail

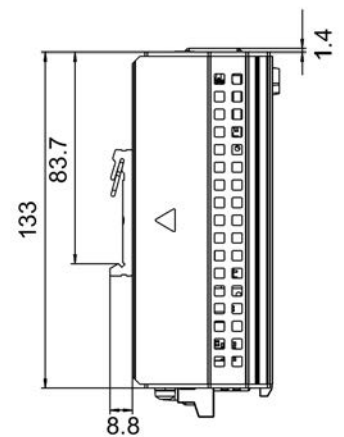
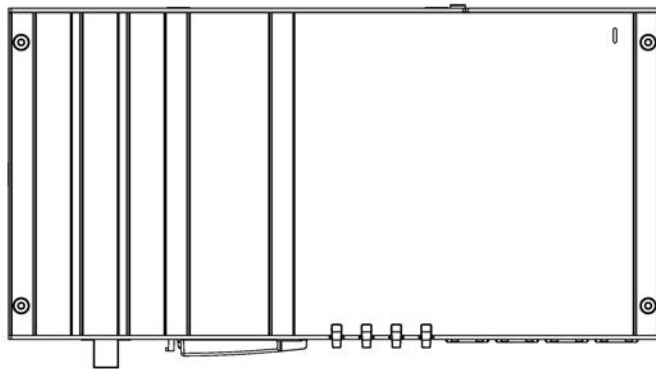
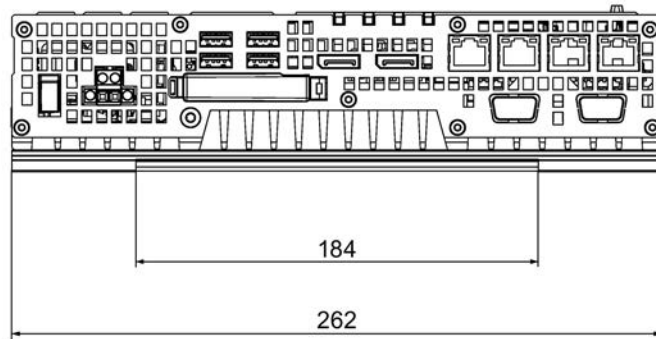

All dimensions in mm

8.4.2 Dimension drawing - wall-mounting

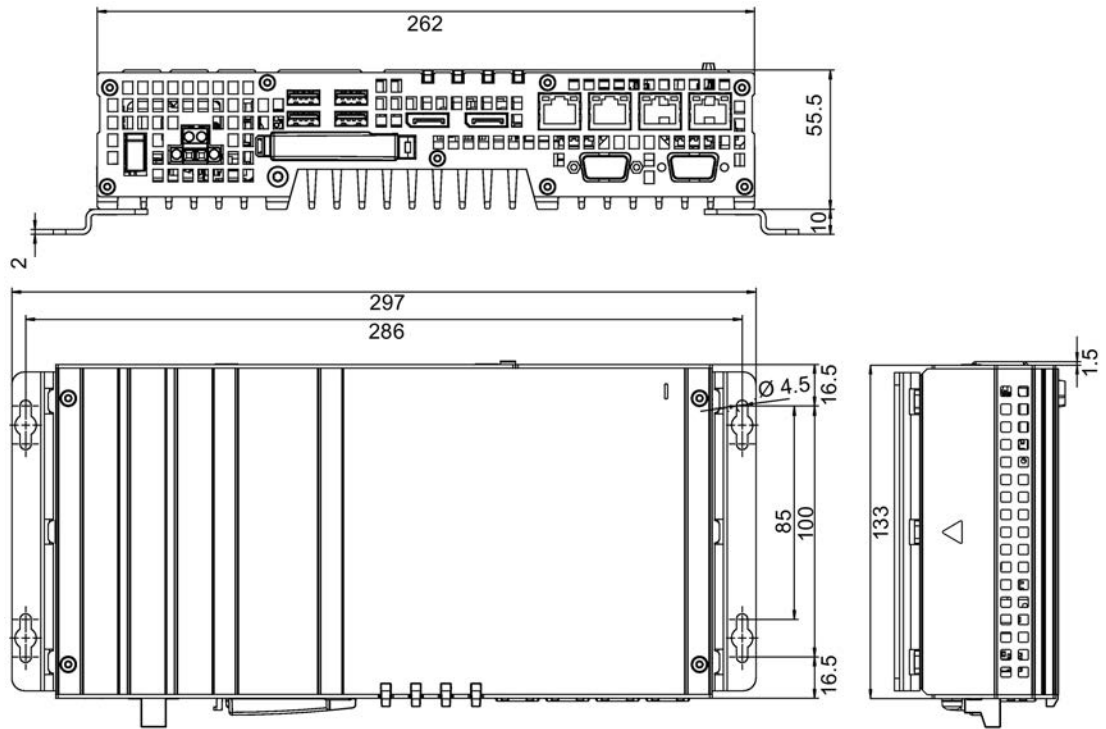

All dimensions in mm

8.4.3 Dimension drawing - vertical mounting

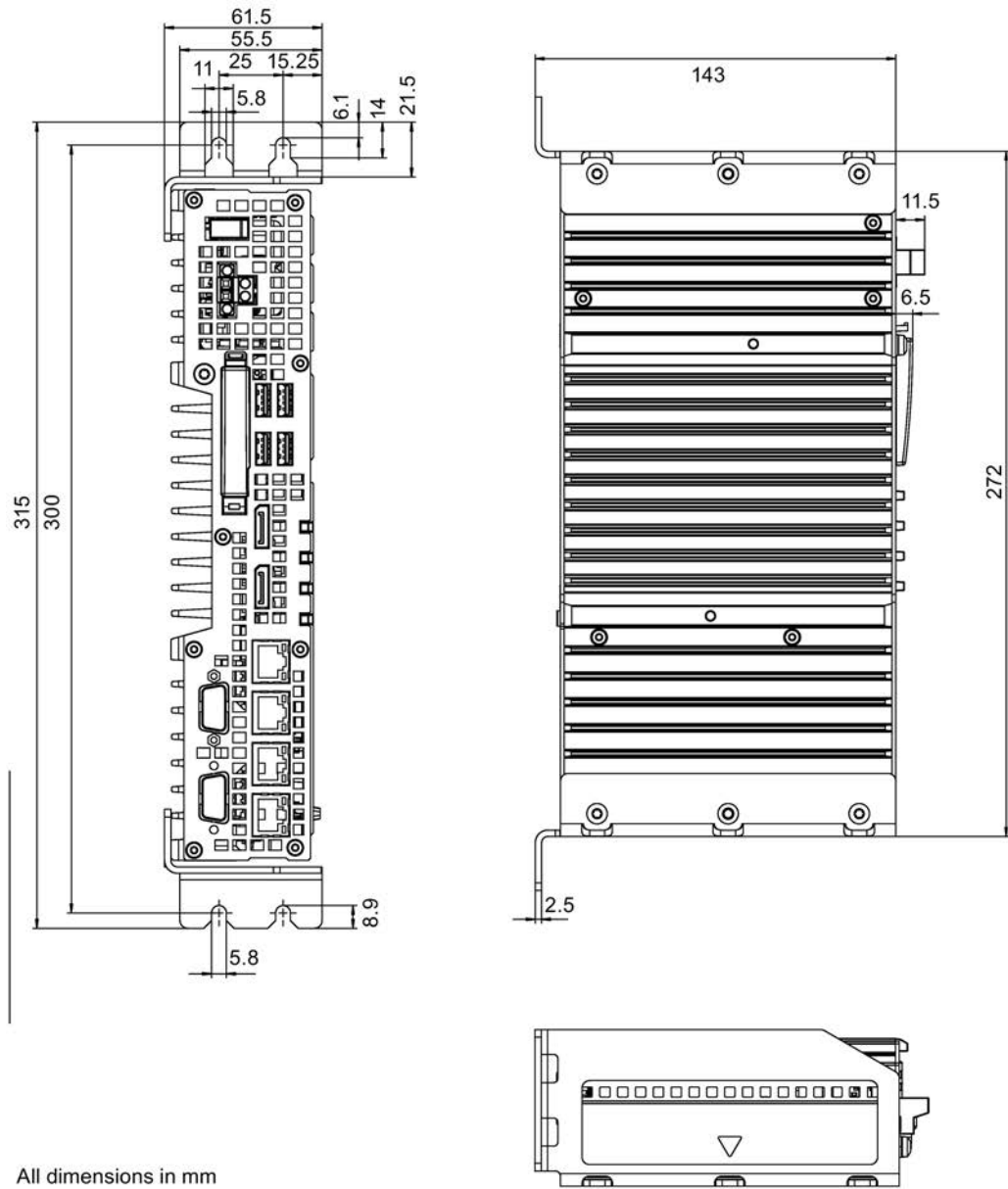

8.4.4 Dimension drawing - device with expansion cards

Device with one expansion card

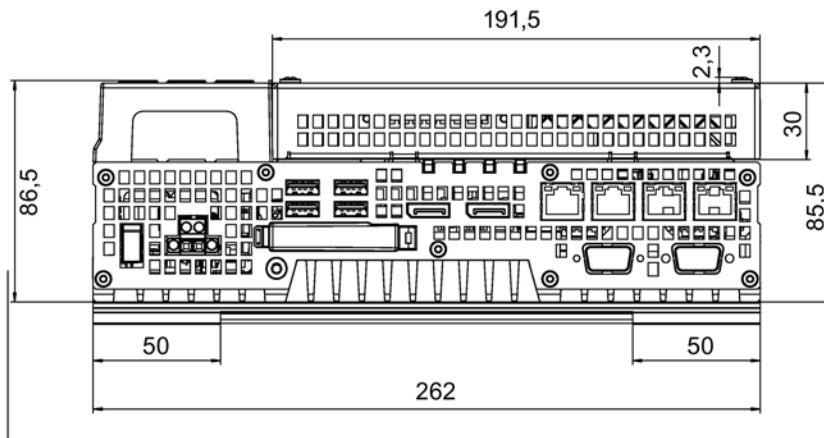

Alle Angaben in mm

Device with two expansion cards

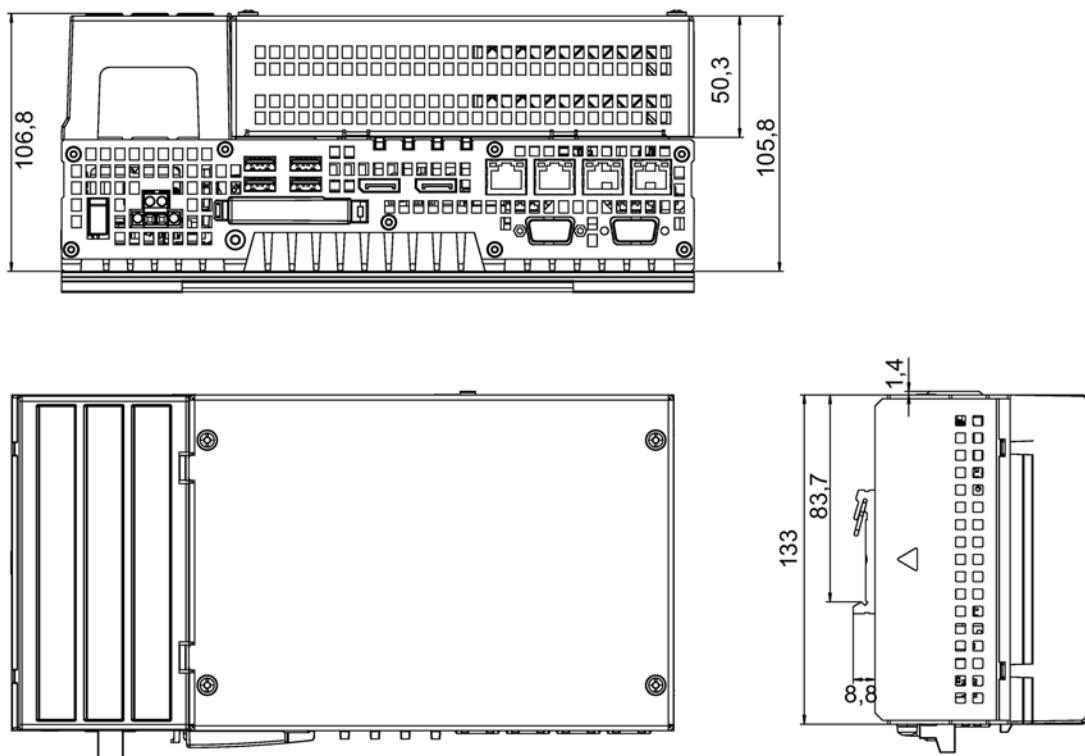

Alle Angaben in mm

8.5 Technical specifications

8.5.1 General technical specifications

General technical specifications

Article numbers	See order documents
Dimensions (base device)	262 × 133 × 55.5 (W × H × D in mm).
Weight	
Base device:	Approx. 2.2 kg
Device with 2x expansion	Approx. 2.7 kg
Supply voltage (DC) ¹	24 V DC ¹ (-20%/+20%)
Short-term voltage interruption in accordance with Namur	Min. 15 ms (at 20.4 V) Max. 10 events/h; recovery time min. 1 s
Max. power consumption	64.8 W (at 24 V)
Degree of protection	IP 20 to IEC 60529
Protection class	Protection class I to IEC 61140
Safety specifications	EN 60950-1; UL 60950-1; CAN/CSA-C22.2 No. 60950-1; UL 508; CAN/CSA-C22.2 No. 142
Noise emission	<40dB (A) to DIN 45635-1
Quality assurance	In accordance with ISO 9001

¹ The device should only be connected to a 24 V DC power supply which meets the requirements of safe extra low voltage (SELV) according to IEC/EN/DIN EN/UL 60950-1. The power supply must meet the requirement NEC Class 2 or LPS according to the IEC/EN/DINEN/UL 60950-1 (see section "Connecting the power supply (Page 41)").

Electromagnetic compatibility

Interference emission	EN 61000-6-3, EN 61000-6-4, CISPR22 class B; FCC class A
Immunity with regard to conducted interference on the supply lines	± 2 kV according to IEC 61000-4-4; burst ± 1 kV according to IEC 61000-4-5; symmetrical surge ± 2 kV according to IEC 61000-4-5; asymmetrical surge
Noise immunity on signal lines	± 1 kV to IEC 61000-4-4; Burst; Length < 3 m ± 2 kV in accordance with IEC 61000-4-4; Burst; length > 3 m ± 2 kV in accordance with IEC 61000-4-5; Surge; length > 30 m
Immunity to electrostatic discharge	± 6 kV contact discharge in accordance with IEC 61000-4-2 ± 8 kV air discharge in accordance with IEC 61000-4-2
Immunity to RF interference	10 V/m 80–2000 MHz, 80% AM according to IEC 61000-4-3 3 V/m 2–2.7 GHz, 80% AM according to IEC 61000-4-3 10 V 10 KHz–80 MHz, 80% AM according to IEC 61000-4-6
Immunity to magnetic fields	100 A/m, 50/60 Hz according to IEC 61000-4-8

Motherboard

Processor	<ul style="list-style-type: none"> • Intel® Celeron® Processor G3902E (2 MB cache, 1.6 GHz) • Intel® Core™ i3-6102E Processor (3 MB cache, 1.9 GHz) • Intel® Core™ i5-6442EQ Processor (6 MB cache, up to 2.7 GHz) • Intel® Xeon® Processor E3-1505L v5 (8 MB cache, up to 2.8 GHz)
Main memory	<p>Memory modules without ECC:</p> <ul style="list-style-type: none"> • 4 GB DDR4-SDRAM SODIMM • 8 GB DDR4-SDRAM SODIMM • 16 GB DDR4-SDRAM SODIMM <p>Memory module with ECC (not combinable with i5 CPU):</p> <ul style="list-style-type: none"> • 8 GB DDR4-SDRAM SODIMM • 16 GB DDR4 SDRAM SODIMM
Buffer memory ¹	512 kB NVRAM optional
Expansion card slots	<p>up to 2 x PCIe cards can be used</p> <p>Max. length of PCIe cards: 175 mm</p> <p>max. permitted power losses: 8 W per PCIe card, 12 W in total</p>

¹ For devices with retentivity

Drive and memory media

Hard disk drive (optional)	2.5", ≥ 320 GB, SATA
Solid State Disk (optional)	2.5", ≥ 80 GB SATA
CFast card (optional)	<ul style="list-style-type: none"> • 2 GB or • 4 GB or • 8 GB or • 16 GB or • 30 GB

Graphics

Graphics controller	Intel® HD Graphics 510 / 530 / P530 (depending on CPU type)
Graphics memory	Occupied in main memory (dynamic UMA)
Graphics resolution	Maximum 4096 x 2304 pixels

Ports

COM1; COM2 (optional)	RS232/RS422/RS485, 115 kbps max., 9-pole D-SUB pin
2 x DisplayPort (DPP)	Connection of display devices with DisplayPort connection
Keyboard	USB support
Mouse	USB support
USB	4 × USB 3.0, a maximum of 2 can be operated in high-current mode at the same time
Ethernet ¹	3 × Ethernet interface (RJ45) (Intel 1x I219LM, 2 x I210) 10/100/1000 Mbps, electrically isolated, teaming-capable ²

¹ For unique labeling, the Ethernet interfaces are numbered on the enclosure. The numbering by the operating system can differ.

² No teaming with AMT.

8.5.2 Ambient conditions

Climatic Conditions

Temperature	Tested to IEC 60068-2-1, IEC 60068-2-2, IEC 60068-2-14
- During operation	<p>Horizontal mounting position: Operation with hard disk:</p> <ul style="list-style-type: none"> with up to two expansion cards (max. load 12 W) in RAL²: +5 to +35 °C¹ <p>Operation with CFast card and/or SSD:</p> <ul style="list-style-type: none"> with up to 2 expansion cards (max. load 12 W) in RAL²: 0 to +45 °C¹ <p>Operation with CFast card:</p> <ul style="list-style-type: none"> with up to 2 expansion cards (max. load 12 W) in RAL²: 0 to +50° C¹ Without expansion cards in RAL²: 0 to +55° C¹ <p>Vertical / portrait mounting position: Operation only with CFast card and/or SSD drive:</p> <ul style="list-style-type: none"> with up to 2 expansion cards (max. load 12 W) in RAL²: 0 to +45 °C¹ <p>Horizontal mounting position: Operation with CFast card</p> <ul style="list-style-type: none"> Without expansion cards in RAL²: 0 to +30° C¹ <p>¹ This information applies to the setting "Standard" in the BIOS Setup, Menu "Power" > "Power&Performance" > "CPU Power Management Control" > "CPU Power Level"; the ambient temperature must be reduced by 5 °C for the setting "Performance Optimized".</p> <p>² RAL = Restricted Access Location Installation of the device in operating facilities with restricted access, for example, locked control cabinet.</p>
- During storage/shipping	-40°C to +60°C (for device with HDD) or -40°C to +70°C (for devices with CFast or SSD)
- Gradient	Operating mode: Max. 10°C/h; Storage: 20°C/h; no condensation
Relative humidity	tested to IEC 60068-2-78, IEC 60068-2-30
- During operation	5% to 80% at 25° C (no condensation)
- During storage/shipping	5% to 95% at 25 °C (no condensation)
Barometric pressure	
- During operation	1080 up to 689 hPa, (corresponds to an elevation of -1000 to 3000 m)
- During storage/shipping	1080 to 660 hPa (corresponds to an altitude of -1000 m to 3500 m)

Mechanical conditions

Vibration	Tested to DIN IEC 60068-2-6
- During operation	with CFast card or SSD: 5 to 9 Hz: 3.5 mm 9 to 500 Hz: 9.8 m/s ² with hard disk and wall installation: 10 to 58 Hz: 0.0375 mm 58 to 200 Hz: 4.9 m/s ² with hard disk and DIN rail mounting or vertical installation: excitation not allowed
- During storage/shipping	5 to 9 Hz: 3.5 mm 9 to 500 Hz: 9.8 m/s ²
Resistance to shock	Tested to DIN IEC 60068-2-27
- During operation	without hard disk drive: 150 m/s ² , 11 ms; with hard disk drive: 50 m/s ² , 30 ms
- During storage/shipping	250 m/s ² , 6 ms

8.5.3 Power demand of the components

Maximum permitted power consumption of the auxiliary components

Auxiliary component		Maximum permitted power consumption			Max. total power
		+5 V	+ 3.3 V	+ 12 V	
USB device	High-current	900 mA	-	-	10 W (for all USB devices)
DisplayPort		-	500 mA	-	
PCIe modules	Per slot	-	1.5 A	0.5 A	8 W for one slot
	Total	-	3 A	1 A	12 W for both slots

The total power for PCIe cards and USB devices may not exceed 15 W

NOTICE
Device can overheat!
To avoid overheating, the power loss per PCIe slot should not exceed 8 watts.

8.5.4 Integrated DC power supply

Input voltage	24 V DC (-20%/+20%)
Output power of the power supply	Max. 80 W
Power failure buffering	Hold-up time ≥ 20 ms with 20.4 V (DC_FAIL is active after > 5 ms)
Efficiency	>85 %

Note

Inrush current

The device needs an inrush current of at least 6.5 A for 15 ms.

The peak value of the starting current depends on the input voltage and the impedance of the 24 V DC power supply. Peak currents greater than 6.5 A are possible. This will not have a negative impact on device functionality.

8.5.5 Typical power consumption

Technical specifications

Typical current and power consumption of the device at a rated voltage of 24 V and full CPU load.

	Current consumption	Power consumption
Device with BIOS setting CPU Power Level = "Temperature Optimized" or "Determinism Optimized"	1000 mA	24 W
Device with BIOS setting CPU Power Level = "Standard"	1200 mA	29 W
Device with BIOS setting CPU Power Level = "Performance Optimized"	1500 mA	36 W
Hard disk drive 2.5" or SSD - additionally	100 mA	2 W
USB expansion ¹ - additionally	Max. 500 mA	Max. 12 W
PCIe expansion ¹ - additionally	Max. 500 mA	Max. 12 W

¹ The total power for PCIe and USB expansions may not exceed 15 W

8.6 Hardware descriptions

8.6.1 External ports

8.6.1.1 COM1 / COM2

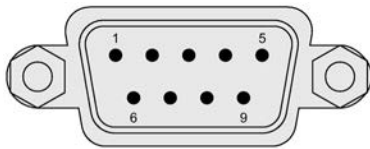

RS232
RS422
RS485

RS-232 assignment

Pin	Short description	Meaning
1	DCD	Data carrier detect (I)
2	RxD	Received data (I)
3	TxD	Transmitted data (O)
4	DTR	Data terminal ready (O)
5	M	Ground
6	DSR	Data set ready (I)
7	RTS	Request to send (O)
8	CTS	Clear to send (I)
9	RI	Incoming call (I)

Pin assignment RS422

Pin	Short description	Meaning
1	TX-	Transmit data - (O) for full-duplex mode
2	TX+	Transmit data + (O) for full-duplex mode
3	RX+	Receive data + (I) for full-duplex mode
4	RX-	Receive data - (I) for full-duplex mode
5	M	Signal ground
6	nc	
7	nc	
8	nc	
9	nc	

Pin assignment RS485

Pin	Short description	Meaning
1	Data-	Transmit / receive data - (I/O) for half-duplex mode
2	Data+	Transmit / receive data+ (I/O) for half-duplex mode
3	nc	
4	nc	
5	M	Signal ground
6	nc	
7	nc	
8	nc	
9	nc	

8.6.1.2 CFast

Pin	Short name	Meaning
S1	SGND	Signal GND (ground for signal integrity)
S2	A+	SATA differential
S3	A-	SATA differential
S4	SGND	Signal GND (ground for signal integrity)
S5	B-	SATA differential
S6	B+	SATA differential
S7	SGND	Signal GND (ground for signal integrity)
PC1	CDI	Card Detect In
PC2	GND	Device GND
PC3	TBD	TBD (not connected)
PC4	TBD	TBD (not connected)
PC5	TBD	TBD (not connected)
PC6	TBD	TBD (not connected)
PC7	GND	Device GND
PC8	LED1	LED Output (not connected)
PC9	LED2	LED Output (not connected)
PC10	IO1	Reserved Input/Output (not connected)
PC11	IO2	Reserved Input/Output (not connected)
PC12	IO3	Reserved Input/Output (not connected)
PC13	PWR	Device Power (3.3V)
PC14	PWR	Device Power (3.3V)
PC15	GND	Device GND
PC16	GND	Device GND
PC17	CDO	Card Detect Out

8.6.1.3 DisplayPort

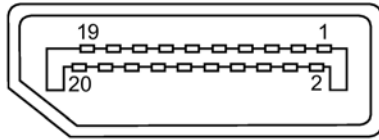

Pin	Short name	Meaning	Input / output
1	ML_Lane0+	DP data 0+	Output
2	GND	Ground	-
3	ML_Lane0-	DP data 0-	Output
4	ML_Lane1+	DP data 1+	Output
5	GND	Ground	-
6	ML_Lane1-	DP data 1-	Output
7	ML_Lane2+	DP data 2+	Output
8	GND	Ground	-
9	ML_Lane2-	DP data 2-	Output
10	ML_Lane3+	DP data 3+	Output
11	GND	Ground	-
12	ML_Lane3-	DP data 3-	Output
13	CONFIG1 CAD	Cable Adapter Detect	Input
14	CONFIG2	Ground (PullDown)	-
15	AUX_CH+	Auxiliary channel+	Bidirectional
16	GND	Ground	-
17	AUX_CH-	Auxiliary channel-	Bidirectional
18	HPD	Hot Plug Detect	Input
19	GND	Ground	-
20	DP_PWR	+3.3V (fused)	Output

8.6.1.4 Ethernet

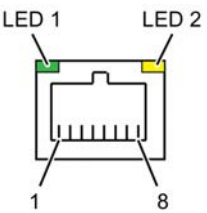
Ethernet RJ45 interface			
			
Pin no.	Short description	Meaning	Input / output
1	BI_DA+	Bi-directional data A+	Input/output
2	BI_DA-	Bi-directional data A-	Input/output
3	BI_DB+	Bi-directional data B+	Input/output
4	BI_DC+	Bi-directional data C+	Input/output
5	BI_DC-	Bi-directional data C-	Input/output
6	BI_DB-	Bi-directional data B-	Input/output
7	BI_DD+	Bi-directional data D+	Input/output
8	BI_DD-	Bi-directional data D-	Input/output
S		Shield	–
	LED 1	Off: 10 Mbps Green light: 100 Mbps Orange light: 1000 Mbps	–
	LED 2	Lit: Active connection, e.g., to a hub Flashing: Activity	–

8.6.1.5 USB 3.0 port

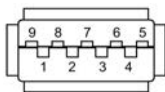

Pin	Short name	Meaning	Input / output
1	VBUS	+ 5 V (fused)	Output
2	D-	Data channel USB2	Input / output
3	D+	Data channel USB2	Input / output
4	GND	Ground	–
5	RX-	Data channel USB3	Input
6	RX+	Data channel USB3	Input
7	GND	Ground	–
8	TX-	Data channel USB3	Output
9	TX+	Data channel USB3	Output

8.6.2 Internal ports

8.6.2.1 PCIe card

Pin assignment for the PCIe-x4 card interface				
Pin no.	Side B		Side A	
	Name	Description	Name	Description
1	+12 V	12 V power	PRSNT1#	Hot-plug presence detect
2	+12 V	12 V power	+12 V	12 V power
3	+12 V	12 V power	+12 V	12 V power
4	GND	Ground	GND	Ground
5	SMCLK	SMBUS (System Management Bus) clock	JTAG2	TCK (Test Clock), clock input for JTAG interface (not connected)
6	SMDAT	SMBus (System Management Bus) data	JTAG3	TDI (Test Data Input) (not connected)
7	GND	Ground	JTAG4	TDO (Test Data Output) (not connected)
8	+3.3V	3.3 V power	JTAG5	TMS (Test Mode Select) (not connected)
9	JTAG1	TRST# (Test Reset) resets the JTAG interface (not connected)	+3.3V	3.3 V power
10	3.3 Vaux	3.3 V auxiliary power	+3.3V	3.3 V power
11	WAKE#	Signal for link reactivation	PERST#	Fundamental reset
12	RSVD	Reserved	GND	Ground
13	GND	Ground	REFCLK+	Reference clock (differential pair)
14	PETp0	Transmitter differential pair, Lane 0	REFCLK-	Reference clock (differential pair)
15	PETn0	Transmitter differential pair, Lane 0	GND	Ground
16	GND	Ground	PERp0	Receiver differential pair, Lane 0
17	PRSNT2#	Hot-plug presence detect (not connected)	PERn0	Receiver differential pair, Lane 0
18	GND	Ground	GND	Ground
19	PETp1	Transmitter differential pair, Lane 1	RSVD	Reserved
20	PETn1	Transmitter differential pair, Lane 1	GND	Ground

Pin assignment for the PCIe-x4 card interface				
21	GND	Ground	PERp1	Receiver differential pair, Lane1
22	GND	Ground	PERn1	Receiver differential pair, Lane1
23	PETp2	Transmitter differential pair, Lane2	GND	Ground
24	PETn2	Transmitter differential pair, Lane2	GND	Ground
25	GND	Ground	PERp2	Receiver differential pair, Lane2
26	GND	Ground	PERn2	Receiver differential pair, Lane2
27	PETp3	Transmitter differential pair, Lane3	GND	Ground
28	PETn3	Transmitter differential pair, Lane3		Ground
29	GND	Ground	PERp3	Receiver differential pair, Lane3
30	RSVD	Reserved	PERn3	Receiver differential pair, Lane3
31	PRSNT2#	Hot-plug presence detect	GND	Ground
32	GND	Ground	RSVD	Reserved

8.6.3 System resources

8.6.3.1 Currently allocated system resources

All system resources (hardware addresses, memory configuration, allocation of interrupts, DMA channels) are assigned dynamically by the Windows OS, depending on the hardware configuration, drivers and connected external devices. You can view the current configuration of system resources or possible conflicts with the following operating systems:

Windows 10 Windows Embedded Standard Windows 7 Ultimate	Start menu "Start": Enter "msinfo32" in the search field and press "Return" to confirm.
---	---

8.6.3.2 Allocation of system resources

The following tables and images describe the system resources for the delivery state of the device.

PCIe interrupt lines

The interrupts are assigned to devices by BIOS. Only non-shared interrupts are available for the first Ethernet interface.

This means that applications or realtime operating system expansions can operate these devices exclusively and with high-performance without having to share the interrupt with other devices.

Interrupt sharing in APIC mode:

Interrupt		Interrupt type
IRQ0	HPET (High Precision Event Timer), when HPET is enabled in the BIOS "Advanced" menu. System Timer, when HPET is disabled.	ISA exclusive
IRQ1	Free	
IRQ2	Interrupt controller 2	ISA exclusive
IRQ3	Com Port 2 (COM2)	ISA exclusive
IRQ4	Com Port 1 (COM1)	ISA exclusive
IRQ5	Free	
IRQ6	Free	
IRQ7	Free	
IRQ8	System CMOS / real-time clock	ISA exclusive
IRQ9	ACPI-SCI (system control interrupt)	
IRQ10	Free	
IRQ11	SMBUS NVRAM (optional)	PCI shared
IRQ12	Free	
IRQ13	Numeric data processor	ISA exclusive

Interrupt		Interrupt type
IRQ14	Free	
IRQ15	Free	
IRQ16	High Definition Audio Controller SATA AHCI Controller LAN1 (I219-LM) Graphics Management Engine Interface USB XHCI Controller	PCI shared
IRQ17	PCIe-x4 slot on Riser	PCI exclusive
IRQ18	PCIe-x1 slot on Riser LAN2 (I210)	PCI shared
IRQ19	LAN3 (I210) (optional)	PCI exclusive
IRQ20	Free	
IRQ21	Free	
IRQ22	Free	
IRQ23	Free	

8.6.4 I/O Address Areas

8.6.4.1 Overview of the internal module registers

The following addresses are used for the internal registers:

Addresses	Input/output unit
I/O 062h	Watchdog enable register / 066h select register (Page 120)
I/O 066h	Watchdog trigger register (read only, address 066h) (Page 122)
I/O 404Eh - 404Fh	Output register LED 1/2/3 and SF LED / RUN/STOP LED (Page 122)
I/O 404Dh	Battery status register (read-only) (Page 123)

8.6.4.2 Watchdog enable register / 066h select register (read/write, address 062h)

Meaning of the bits

Watchdog enable register / 066h select register (r/w address 062h)									
Bit								Meaning of the bits	
7	6	5	4	3	2	1	0		
								Watchdog enable bit (WDE)	
							0	Watchdog circuit disabled	
							1	Watchdog circuit enabled	
								Watchdog Mode	
							0	Standard	
							1	Macro	
								066h select register selection	
							0	Reserved	
							1		
								Scaler watchdog time (Normal/Macro)	
		0	0	0				94 ms / 2 s (default)	
		0	0	1				210 ms / 4 s	
		0	1	0				340 ms / 6 s	
		0	1	1				460 ms / 8 s	
		1	0	0				590 ms / 16 s	
		1	0	1				710 ms / 32 s	
		1	1	0				840 ms / 48 s	
		1	1	1				960 ms / 64 s	

Watchdog enable register / 066h select register (r/w address 062h)							
Trigger red Watchdog LED							
	0						Red LED (WD) off
	1						Red LED (WD) on
Watchdog error / Display and reset							
0							WD inactive
1							WD triggered Reset LED after watchdog alarm (Bit 7 = write 1)

8.6.4.3 Watchdog trigger register (read only, address 066h)

Watchdog trigger register

The watchdog is triggered by a read action (address 066h) by this register. The result of the read access can be disregarded (i.e., dummy read).

8.6.4.4 Output register user LED L1/L2/L3 (read/write, address 404Eh)

Meaning of the bits

The "PC ON/WD" LED flashes yellow to indicate the progress of the BIOS self-test during device startup. After the BIOS self-test has been completed, the "PC ON/WD" LED lights up continuously green.

Output register L1/L2/L3 (read/write, address 404Eh)							
Bits							
15	14	13	12-8	7	6	5	4-0
1				1			LED L1 / Run/Stop dark (default)
1				0			LED L1 / Run/Stop lit yellow
0				x			LED L1 / Run/Stop lit green
	1				1		LED L2 / SF dark (default)
	0				x		LED L2 / SF lit red
	1				0		LED L2 / SF lit yellow
		1				1	LED L3 / Maint dark (default)
		0				x	LED L3 / Maint lit red
		1				0	LED L3 / Maint lit yellow
		xxxx xx				xxxx xx	Reserved (read/write)

8.6.4.5 Battery status register (read-only, address 404Dh)

To monitor the status of the CMOS battery, the battery monitoring must be switched on via a special GPIO register.

The status of the CMOS battery (two-tier) can be read out via the batter status register.

Meaning of the bits

Battery status register (read-only, address 404Dh)								
Bit								Meaning
7	6	5	4	3	2	1	0	
0	0							CMOS battery capacity is still sufficient.
0	1							CMOS battery capacity is exhausted (remaining capacity is sufficient for approx. one month)
1	1							CMOS battery is empty

8.6.4.6 NVRAM address register

NVRAM occupies a 512 KB memory address area that can be read via PCI registers.

Meaning of the bits

NVRAM address register		
PCI register address: NVRAM base address register	PCI register content: NVRAM memory address (default)	Length of the memory area
E300 0000	Address is assigned dynamically (depending on device configuration)	80000 h

8.7 BIOS description

8.7.1 Overview

Parameterize your device in the BIOS Setup.

BIOS Setup program

The BIOS Setup program, or BIOS Setup for short, is located, together with the setup parameters, in a FLASH block on the motherboard.

Change the setup parameters of the device in the BIOS Setup, e.g. system time or boot sequence.

Changing the device configuration

Your device configuration is preset for operating with the included software. You should only change the default setup parameters if technical modifications to your device require different parameters.

NOTICE
Malfunctions can occur with running software CPU
If a BIOS update of the PC is performed while SIMATIC software controller, a SIMATIC WinAC for example, is running, the software CPU can malfunction, resulting in communication interruptions or failures, for example. Other actions that put a heavy load on the PC hardware, for example, running hardware tests such as benchmarks, can result in malfunctions of the software CPU.
Do not run a BIOS update or other actions that would put a heavy load on the hardware during operation of a software CPU.
Switch the software CPU to "STOP" before you run a BIOS update or perform other critical actions.

Note

Documentation

BIOS Setup is described for all devices and device configurations. Some BIOS submenus or Setup parameters may not be included, depending on your order. The interface of your BIOS Setup can deviate from the figures in this document.

You can find a detailed description of the BIOS on the Support website under Entry ID 92189178 (<http://support.automation.siemens.com/WW/view/en/92189178>).

8.7.2 Opening the BIOS selection menu

Procedure

1. Reset the device (warm or cold restart).
Depending on the device version, the default settings can differ from the figures shown.
The following message appears briefly on the display at the end of the self-test:

Press ESC for boot options

2. Press <ESC> to open the BIOS selection menu:



The following keys are available in the BIOS selection menu:

Buttons	Function
Continue	Exit selection menu, continue start sequence
Boot Manager	Specify the boot media from which to boot: <ul style="list-style-type: none"> • Hard disk drive • USB drive
Device Management	Start device manager for UEFI boot media
Boot From File	Boot from File: Start from an ".EFI" file
Secure Boot Option ¹	Configuration settings to start the device in Secure Boot mode. The only software modules loaded are those that are known to be safe for the BIOS or the operating system.
SCU	Start BIOS Setup via Setup Configuration Utility
BIOS Update	Update BIOS from USB memory stick
MEBx	Start Intel Management Engine BIOS Extension from Active Management Technology Support (AMT)

¹ Supported by Windows 8 and higher

See also

General installation procedure (Page 81)

8.7.3 Structure of the BIOS Setup menu

The individual setup parameters are distributed between different menus and submenus. Not all menus are included in each supplied device configuration. The following table shows the menus.

Menu	Meaning
Main	Display system information, for example, BIOS version, processor and memory
Advanced	Configure hardware using different submenus
Security	Security functions, e.g., setting a password
Power	Specify power management of CPU and the device
Boot	Determine boot options, e.g., boot order
Exit	Save and exit (see Exit menu)

The menus always have the same structure. The figure below shows an example for the "Main" menu. Device-specific information is shown blurred.

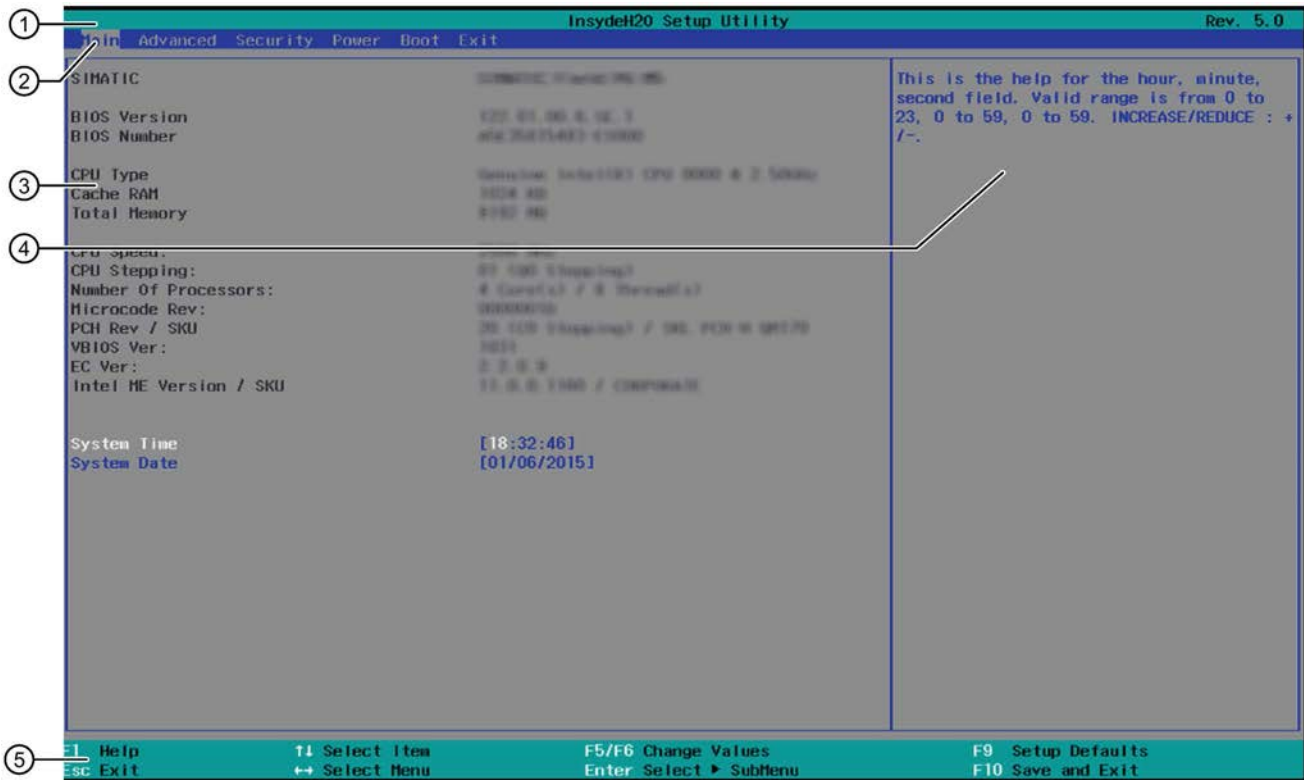

- | | |
|--|---|
| ① Header | The current version of the selected BIOS Setup is displayed in the header. |
| ② Menu bar | Switch between the various menus "Main", "Advanced", etc. in the menu bar at the top. |
| ③ Settings, submenus and device-specific information | Information about your device is displayed in the center left-hand area; here you can edit settings which are partly in submenus. |
| ④ Help area | Short help texts on the currently selected setup parameters are displayed in the center right-hand area. |
| ⑤ Key assignment | The key assignment for navigation in the BIOS Setup is found in the footer. |

8.7.4 Exit menu

You always exit BIOS Setup in this menu.

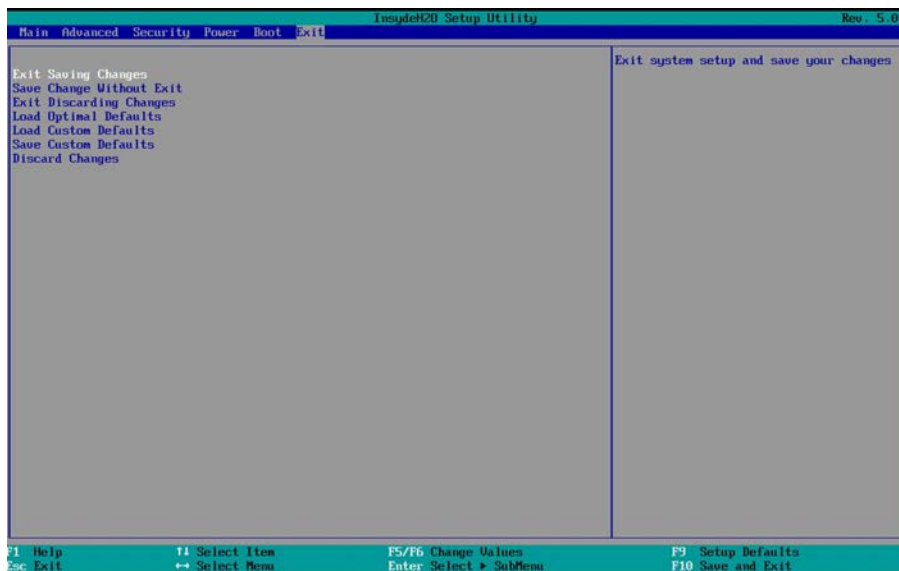

Exit Saving Changes	All changes are saved and the system is restarted with the new Setup parameters.
Save Change Without Exit	All changes are saved
Exit Discarding Changes	All changes are discarded and the system is restarted with the old Setup parameters.
Load Optimal Defaults	All setup parameters are reset to the safe default values. Notice: The existing Setup parameters are overwritten by this.
Load Custom Defaults	The profile must be loaded with the custom Setup parameters. Requirement: The parameters are saved prior to this with "Save Custom Defaults". Notice: All existing Setup parameters are overwritten during loading. <ul style="list-style-type: none"> • Write down the BIOS Setup settings beforehand • Save the BIOS Setup settings as user-specific profile.
Save Custom Defaults	The currently configured Setup parameters are saved as a custom profile (see also "Load Custom Defaults").
Discard Changes	All changes are discarded.

8.7.5 BIOS update

Check regularly if updates are available for download to your device.

Additional information can be found on the Internet at the following address: After Sales Information System (<http://www.siemens.com/asis>).

Noting down and restoring BIOS Setup settings

NOTICE

Irretrievable loss of data

All BIOS Setup settings are deleted after the BIOS update. This can put the system in an undefined state. This may damage the device and the plant.

1. Make a note of your specific BIOS Setup settings before the BIOS update.
2. Start BIOS Setup after the BIOS update.
3. Load the BIOS Setup default settings with <F9> "Setup Defaults". Or use the BIOS Setup command "Load Optimal Defaults" in the "Exit" menu.
4. Make your own Setup settings again.
5. Save the BIOS Setup settings with <F10> "Save and Exit".

Performing a BIOS update

NOTICE

Damage to the device

If you switch off the device during the update, the BIOS will be incomplete and corrupt. This may result in malfunctions.

Leave the device switched on during the update.

If you have purchased a new BIOS update for your device, follow these steps to install the update:

1. Connect the device to the power supply.
2. Copy the update to a USB memory stick.
3. Reset the device (warm or cold restart).

The following message appears briefly on the display at the end of the self-test:

Press ESC for boot options

4. Press <ESC> to open the BIOS selection menu.
5. Click the "BIOS Update" button.
6. Follow the instructions on the screen.

Reboots

There may be several reboots after a BIOS update. These reboots are initiated by the Management Engine (ME). The reboots are required by the ME to adapt itself to the changes of the BIOS update.

8.7.6 Alarm, error and system messages

During startup (the boot process), the BIOS first performs a **Power On Self Test (POST)** and checks whether certain functional units of the PC are operating error-free. The boot sequence is immediately interrupted if critical errors occur.

BIOS initializes and tests further functional units if the POST does not return any errors. In this startup phase, the graphics controller is initialized and any error messages are output to the screen.

The error messages output by system BIOS are listed below. For information on error messages output by the operating system or application programs, refer to the corresponding manuals.

On-screen error messages

On-screen error message	Meaning / tip
Operating system not found	Possible causes: <ul style="list-style-type: none"> • No operating system installed • Incorrect active boot partition • Wrong boot drive settings in SETUP
SMART failure detected on HDD	Hard disk reports pending failure through S.M.A.R.T.
CMOS battery failed	CMOS battery is empty or not connected.
Real-time clock has lost power	The CMOS clock was operated without battery or with a battery that was too weak, during battery change, for example. Check the CMOS clock.
Keyboard controller error or no keyboard present	Keyboard defective or not connected

8.8 Active Management Technology (AMT)

8.8.1 Introduction

Intel® Active Management Technology (Intel® AMT) is an Intel technology for the remote maintenance of SIMATIC Industrial PCs (IPCs) with AMT technology using a management PC. It is not necessary to install an operating system on the SIMATIC IPC with Intel® AM. Intel® AMT provides numerous functions, e.g.:

- **Keyboard Video Mouse (KVM) Redirection**

KVM connections are always possible using the KVM server that is integrated in the firmware. KVM enables access to IPCs with a corrupted or no operating system as the KVM server is integrated in the AMT hardware. KVM enables you to reboot a remote computer and make changes to its BIOS settings.

- **Remote power management**

SIMATIC IPC with Intel® AMT can be switched on and off or restarted using another PC.

- **IDE redirection**

An image on the management PC can be integrated and used on the SIMATIC IPC with Intel® AMT both as a CD/DVD drive and as a floppy drive. If the image is bootable, you can also boot the SIMATIC IPC with Intel® AMT from it.

The following figure shows remote maintenance of SIMATIC IPCs with Intel® AMT, e.g. for troubleshooting a corrupt operating system or incorrect BIOS settings:

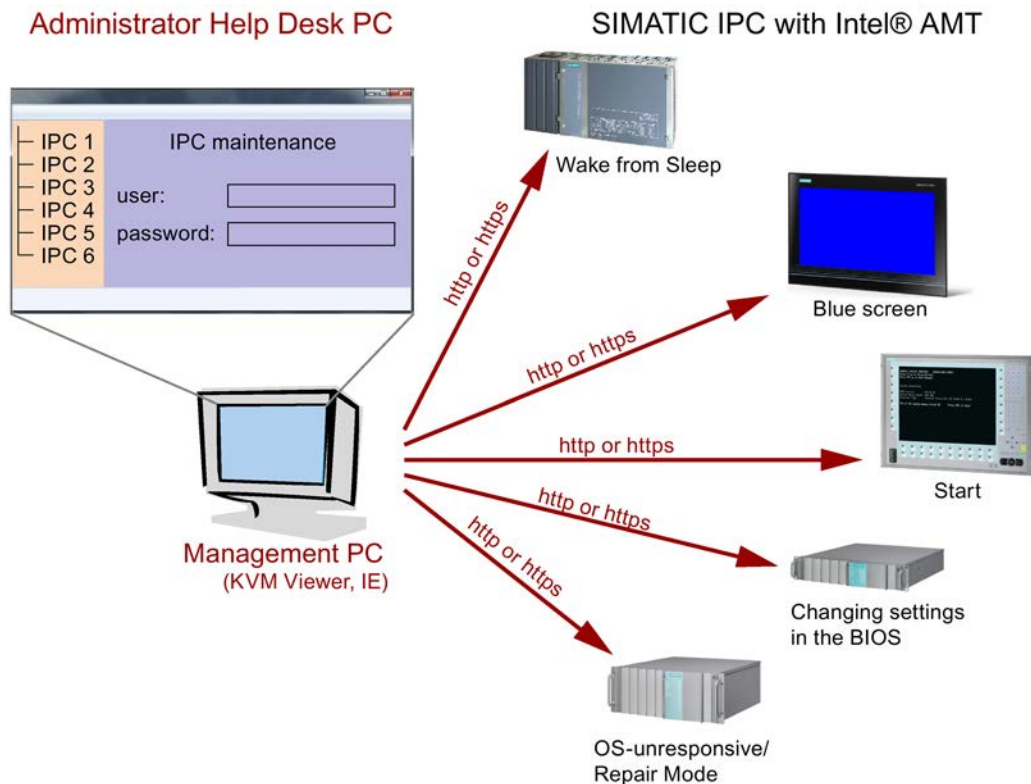

8.8.2 Overview of AMT

This section describes the required measures and settings on the local IPC so that the IPC can be controlled and maintained remotely from a management station known below as the help desk PC.

The local IPC is known below as the "AMT PC".

The sections contain the following information:

- AMT settings in the MEBx and in the BIOS setup
- Basic configuration of AMT
- Further useful notes

8.8.3 Enabling Intel® AMT / basic configuration

For security reasons, Intel® AMT is not enabled on new devices. The Management Engine (ME) is always active.

Procedure

For IPC427E devices:

1. If necessary, first reset Intel® AMT to the default settings (see Resetting the Intel® AMT to the default settings and disabling AMT (Page 135)).
2. To open the BIOS selection menu, press the <ESC> key while the device is booting.
3. Open the BIOS Setup using the "Setup Configuration Utility (SCU)".
4. Select the "Active Management Technology Support" command in the Advanced menu.
5. Activate the options "Intel AMT Configuration Screens".
6. For IPC547D and PC547E devices only: Select the "Normal" setting for "MEBx Mode".
7. Exit the BIOS Setup with the <ESC> key.
8. Start the MEBx Setup via "MEBx".

Settings in the MEBx

1. Use the arrow keys to select "MEBx" and confirm with the <Enter> key.
2. Select "MEBx Login".
3. Enter the default password "admin".

Change the password. The new password must comprise:

- At least eight characters
- At least one upper case letter
- At least one lower case letter
- At least one number
- At least one special character (! @ # \$ % ^ & *)
- The underscore "_" and space characters are valid in the string but do not increase the complexity of the password.

Note

If the password is no longer available, you must reset the Intel® AMT to the default settings, see [Resetting the Intel® AMT to the default settings and disabling AMT](#) (Page 135).

Backup the password to protect it against loss.

4. Switch to the "Intel (R) AMT Configuration" submenu and enable "Manageability Feature Selection".
5. Switch to the "Intel(R) ME General Settings" submenu and enable access via the network with "Activate Network Access".
6. Confirm the dialogs that appear with "Y".

Drivers are automatically installed once as required in the subsequent restart.

8.8.4 Resetting the Intel® AMT to the default settings and disabling AMT

If Intel® AMT has already been configured, it is advisable to reset Intel® AMT to the default settings. One effect of resetting to the default settings is that Intel® AMT is disabled.

You can skip this point if you have a new IPC in the factory state.

Procedure

Proceed as follows to reset the Intel® AMT to the default values:

1. To open the BIOS selection menu, press the <ESC> key while the device is booting.
2. Press "F2" in the boot sequence to open the BIOS.
3. Open the BIOS Setup using the "Setup Configuration Utility (SCU)".
4. Select the "Active Management Technology Support" command in the Advanced menu.
5. Activate the option "Intel AMT Configuration Screens" and "Un-Configure ME".
6. Set "Un-Configure ME" or "Un-Configure AMT/ME" to Enabled.
7. Exit the BIOS with "F10" (Save and Exit).

The following prompt will appear after an automatic restart:

```
Found unconfigure of Intel(R) ME
Continue with unconfiguration (Y/N)
```

8. Confirm this prompt with "Y" ("Z" on a German keyboard) to discard all settings in the Management Engine (ME).
The following message appears: "Unconfiguration in process...". The device is automatically restarted.
9. For IPC627C/827C/677C/647C/847C/427D/427E/477D/477E/Field PG M4, you now need to set the "Un-Configure ME" menu item in the BIOS back to Disabled.

8.8.5 Determining the network address

To connect the AMT PC with the AMT server, the network address that uniquely localizes the AMT server on the AMT PC must be entered.

If DHCP is set for the automatic assignment of the network address in "Network Setup" in the MEBx of the AMT PC, the network address is not fixed.

Procedure

If the AMT server uses the same network address as the operating system of the AMT PC (most common situation):

1. You can obtain the address of the AMT server in the command line in Windows using "ipconfig" and in UNIX using "ifconfig".

If the AMT server and operating system do not use the same network address, ask your network administrator for the address you have been assigned.

8.8.6 Forcing user consent

When establishing a connection to the AMT PC, the KVM viewer may prompt the user to enter a six-figure code. This code is displayed on the screen of the AMT PC. The user of the AMT PC must inform the user of the KVM viewer of this code.

This code query needs to be set up on the KVM viewer.

Procedure

1. Select "Intel(R) AMT Configuration > User Consent" in the MEBx.
2. Select the value "KVM" for "User Consent".

To allow a user with administrator privileges to avoid this code query, follow these steps:

1. Select "Intel(R) AMT Configuration > User Consent" in the MEBx.
2. Enable "Opt-in configurable from remote IT".

8.9 Functional scope in Windows

8.9.1 Windows Embedded Standard 7

The overview shows the most important device functions under Windows Embedded Standard 7:

Function	HDD / SSD version	Memory card version
.Net Framework	Available, V3.5	Available, V3.5
Accessories	Available	Available
Aero background	Available	Available
Backup and Restore	Available	Available
Bluetooth	Available	Available
Dialog box filter	Available	Available
DirectX and Windows Device Experience	Available, V11	Available, V11
Domain services	Available	Available
Driver database	Available	Not available
Driver frameworks	Available	Available
Encrypted File System (EFS)	Available	Available
Enhanced Write Filter	Available	Available
Fax and Scan	Available	Available
File Based Write Filter (FBWF)	Available	Available
Fonts	134	48
Help and Support Engine	Available	Available
Hibernate Once Resume Many (HORM)	Available	Available
Image Mastering API V2	Available	Available
IME Base Components	Available	Available
Internet Explorer	Available, IE 11	Available, IE 11
Internet Information Server (IIS)	Available, V7.0	Available, V7.0
Language (Standard)	English ¹	English ¹
Mobility Center	Available	Available
Network and Sharing Center	Available	Available
Network Diagnostics	Available	Available
Pagefile	Available	Available
Printing Utilities and Management	Available	Available
Registry Filter	Available	Available
Remote Assistance	Available	Available
Remote Client	Available	Available
Remote Desktop	Available	Available
SIMATIC IPC DiagBase	Available	Available
Speech	Available	Not available
System Management Administrative Tools	Available	Available

Function	HDD / SSD version	Memory card version
Telnet Server	Available	Available
User Account Control	Available	Available
Windows Explorer Shell	Available	Available
Windows Firewall	Available	Available
Windows Installer	Available	Available
Windows Media Player	Available, V12	Available, V12
Windows PowerShell 2.0	Available	Available
Windows Search and Natural Language 6	Available	Available
Windows Security Center	Available	Available
Windows Update	Available	Available
Wireless Networking	Available	Available

¹ Note the licensing agreements for Windows Embedded Standard 7.

Additional information on language selection is available in the section "Setting up the language selection by means of the Multilanguage User Interface (MUI) (Page 85)".

Technical support

A.1 Service and support

You can find additional information and support for the products described on the Internet at the following addresses:

- Technical support (<https://support.industry.siemens.com>)
- Support request form (<http://www.siemens.com/automation/support-request>)
- After Sales Information System SIMATIC IPC/PG (<http://www.siemens.com/asis>)
- SIMATIC Documentation Collection (<http://www.siemens.com/simatic-tech-doku-portal>)
- Your local representative (<http://www.automation.siemens.com/mcms/aspa-db/en/Pages/default.aspx>)
- Training center (<http://sitrain.automation.siemens.com/sitrainworld/?AppLang=en>)
- Industry Mall (<https://mall.industry.siemens.com>)

When contacting your local representative or Technical Support, please have the following information at hand:

- MLFB of the device
- BIOS version for industrial PC or image version of the device
- Other installed hardware
- Other installed software

Tools & downloads

Please check regularly if updates and hotfixes are available for download to your device. The download area is available on the Internet at the following link:

After Sales Information System SIMATIC IPC/PG (<http://www.siemens.com/asis>)

A.2 Troubleshooting

This section provides you with tips on how to locate and troubleshoot common problems.

Problem	Possible cause	To correct or avoid error
The device is not operational.	There is no power supply to the device.	Check if the power switch is set to ON.
The monitor remains dark.	The monitor is switched off.	Switch on the monitor.
	The monitor is in "powersave" mode.	Press any key on the keyboard.
	The brightness button has been set to dark.	Set the monitor brightness button to obtain more light. For detailed information, refer to the monitor operating instructions.
	The power cord or the monitor cable is not connected.	<ul style="list-style-type: none"> Check whether the power cord has been properly connected to the monitor and to the system unit or to the grounded shockproof outlet. Check whether the monitor cable has been properly connected to the system unit and to the monitor. <p>If the monitor screen still remains dark after you have performed these checks, please contact your technical support team.</p>
The mouse pointer does not appear on the screen.	The mouse driver is not loaded.	Check whether the mouse driver is properly installed and present when you start the application program. For more detailed information, refer to the manuals for the mouse or application programs.
	The mouse is not connected.	Check whether the mouse cord is properly connected to the system unit. If you use an adapter or extension on the mouse cable, also check the connectors.
		If the mouse pointer still does not appear on the screen after you have performed these checks and measures, please contact your technical support team.
Wrong time and/or date on the PC.		<ul style="list-style-type: none"> Press <ESC> during the booting process to open the BIOS Setup. Set the time and date in the setup menu.
Although the BIOS setting is OK, the time and data are still wrong.	The backup battery is dead.	In this case, please contact your technical support team.
USB device not responding.	Operating system does not support the USB port.	No remedy
	The operating system does not have a suitable driver for the USB device.	<p>Install a suitable driver; the correct driver can often be downloaded from the homepage of the device's manufacturer.</p> <p>The EWF for Windows Embedded Standard must first be disabled.</p>

A.3 Notes on the use of third-party modules

Problem	Possible cause	Possible remedy
The PC crashes during startup.	<ul style="list-style-type: none"> • I/O addresses are assigned twice. • Hardware interrupts and/or DMA channels are assigned twice • Signal frequencies or signal levels are not adhered to • Different connector pin assignments 	<p>Check your computer configuration:</p> <ul style="list-style-type: none"> • If the computer configuration corresponds with factory state, please contact your technical support team. • If the computer configuration has changed, restore the original factory settings. Remove all third-party expansion cards, then restart the PC. If the error no longer occurs, the third-party expansion card was the cause of the fault. Replace this expansion card with a Siemens card or contact the card supplier.
		If the PC still crashes, contact your technical support team.
	PCIe Gen1 expansion card does not behave according to specification.	<ol style="list-style-type: none"> 1. Remove the expansion card. 2. Set the respective setup parameter "PCIe Speed" permanently to "Gen1" in the "Advanced > PCI Express Configuration" menu, submenu "PCI Express Root Port #" of the BIOS Setup. 3. Set the respective setup parameter "PEG# - Gen X" permanently to "Gen1" in the "Advanced > Video Configuration" menu, submenu "Pci Express Graphic" of the BIOS Setup. 4. Install the expansion card again.









Markings and symbols

B.1 Overview



The following tables show all the symbols which may be found on your SIMATIC industrial PC, SIMATIC industrial monitor or SIMATIC Field PG in addition to the symbols which are explained in the operating instructions.

The symbols on your device may vary in some details from the symbols shown in the following tables.

B.2 Safety











Symbol	Meaning	Symbol	Meaning
	Warning, observe the supplied documentation.		Lock is closed
	Attention, radio equipment		Lock is open
	Disconnect the power plug before opening		Opening for Kensington lock
	Attention ESD (Electrostatic sensitive device)		Warning of hot surface

B.3 Operator controls

Symbol	Meaning	Symbol	Meaning
	On/off switch, without electrical isolation		Eject CD/DVD
	On/off switch, without electrical isolation		

B.4 Certificates, approvals and markings



















The following table shows symbols relating to certificates, approvals and markings which may be on the device. You can find more information in the operating instructions for your device:

Symbol	Meaning	Symbol	Meaning
	Approved for Australia and New Zealand		Marking for the Eurasian Customs Union
	Approved for China		Test mark of Factory Mutual Research
	CE markings for European countries		Marking of Federal Communications Commission for the USA
	EFUP (Environment Friendly Use Period) marking for China		Approved for Korea
	Test mark of the Underwriters Laboratories		Disposal information, observe the local regulations.

B.5 Interfaces

The following table shows symbols relating to ports that may be available on the device.

You can find more information in the operating instructions for your device:

Symbol	Meaning	Symbol	Meaning
	Connection to the power supply		PS/2 mouse interface
	Protective conductor terminal		PS/2 keyboard-interface
	Connection for functional earthing (equipotential bonding line)		Multimedia Card Reader
DPP	DisplayPort interface		Smart Card Reader
	DVI-D interface		Line In
LAN 	LAN interface, not approved for connecting WAN or telephone		Line Out
	Serial port		Microphone input
	USB port		Universal Audio Jack
	USB 2.0 high-speed port		Headphone output
	USB 3.0 super-speed port		

List of abbreviations

Abbreviation	Term	Meaning
AC	Alternating current	Alternating current
ACPI	Advanced Configuration and Power Interface	
PLC	Programmable controller	
AGP	Accelerated Graphics Port	High speed bus system
AHCI	Advanced Host Controller Interface	Standardized controller interface for SATA devices. This is supported in Microsoft Windows XP as of SP1 and IAA driver.
APIC	Advanced Programmable Interrupt Controller	Extended programmable interrupt controller
APM	Advanced Power Management	Tool for monitoring and reducing power consumption of the PC
AS	Automation system	
ASIS	After Sales Information System	
AT	Advanced Technology	
ATA	Advanced Technology Attachment	
ATX	AT-Bus-Extended	
AWG	American Wire Gauge	US standard for the cable diameter
BIOS	Basic Input Output System	Basic Input Output System
CAN	Controller Area Network	
CD-ROM	Compact Disc – Read Only Memory	Removable storage medium for large data volumes
CD-RW	Compact Disc – Rewritable	Rewritable CD
CE	Communauté Européenne (CE symbol)	The product is in conformance with all applicable EC directives
CFast	CF + AST	The acronym CFast is the combination of CF (CompactFlash) and AST (ATA Serial Transport).
CGA	Color Graphics Adapter	Standard monitor interface
CLK	Clock pulse	Clock signal for controllers
CMOS	Complementary Metal Oxide Semiconductors	Complementary metal oxide semiconductors
COA	Certificate of authentication	Microsoft Windows Product Key
CoL	Certificate of License	License authorization
COM	Communications Port	Term for the serial interface
CP	Communication Processor	Communication computer
CPU	Central Processing Unit	CPU
CRT	Cathode Ray Tube	

Abbreviation	Term	Meaning
CSA	Canadian Standards Association	Canadian organization for tests and certifications according to own or binational standards (with UL / USA) standards
CTS	Clear To Send	Clear to send
DRAM	Dynamic Random Access Memory	
DC	Direct Current	DC current
DCD	Data Carrier Detect	Data carrier signal detection
DMA	Direct Memory Access	Direct memory access
DOS	Disk Operating System	Operating system without GUI
DPP	DisplayPort	New powerful digital monitor port
DQS	Deutsche Gesellschaft zur Zertifizierung von Qualitätsmanagement mBH	
DDRAM	Double Data Random Access Memory	Memory chip with high-speed interface
DSR	Data Set Ready	Ready for operation
DTR	Data Terminal Ready	Data terminal is ready
DVD	Digital Versatile Disk	Digital versatile disk
DVI	Digital Visual Interface	Digital display interface
DVI-I	Digital Visual Interface	Digital display interface with digital and VGA signals
ECC	Error checking and correction	Error correction code
ECP	Extended capability port	Extended parallel port
EFI	Extensible Firmware Interface	
EGA	Enhanced Graphics Adapter	PC to monitor interface
ESD	Electrostatic-sensitive components	
DM	Electronic Manual	
EIDE	Enhanced Integrated Drive Electronics	An enhancement of the IDE standard
EISA	Extended Industry Standard Architecture	Extended ISA standard
EMM	Expanded Memory Manager	Manages memory expansions
EM64T	Extended Memory 64 technology	
EN	European standard	
EPROM / EEPROM	Erasable Programmable Read-Only Memory / Electrically Erasable Programmable Read-Only Memory	Plug-in submodules with EPROM/EEPROM chips
EPP	Enhanced Parallel Port	Bi-directional Centronics interface
ESC	Escape character	Control character
EWf	Enhanced Write Filter	
FAQ	Frequently Asked Questions	FAQs
FAT 32	File Allocation Table 32-bit	32-bit file allocation table
FBWF	File Based Write Filter	
FD	Floppy disk	Disk drive, 3.5"
FSB	Front Side Bus	
GND	Ground	Chassis ground
HD	Hard disk	Hard disk

Abbreviation	Term	Meaning
HDA	High Definition Audio	
HDD	Hard Disk Drive	Hard disk drive
HU	Height unit	
HMI	Human Machine Interface	User interface
HORM	Hibernate Once - Resume Many	
HT	Hyper-Threading	
HTML	Hyper Text Markup Language	Script language for creating Internet pages.
HTTP	Hypertext Transfer Protocol	Protocol for data transfer on the Internet
Hardware	Hardware	
IAMT	Intel Active Management Technology	Technology that permits the diagnostics, management and remote control of PCs
I/O	Input/Output	Data input/output on computers
IAA	Intel Application Accelerator	
IDE	Integrated Device Electronics	
IEC	International Electrical Commission	
IGD	Integrated Graphics Device	
IP	Ingress Protection	Degree of protection
IR	Infrared	Infrared
IRDA	Infrared Data Association	Standard for data transfer via IR module
IRQ	Interrupt Request	Interrupt request
ISA	Industry Standard Architecture	Bus for expansion modules
ITE	Information Technology Equipment	
L2C	Level 2 cache	
LAN	Local Area Network	Computer network that is limited to a local area.
LCD	Liquid Crystal Display	Liquid crystal display
LED	Light Emitting Diode	Light emitting diode
LPT	Line Printer	Printer port
LVDS	Low Voltage Differential Signaling	
LW	Drive	
MAC	Media access control	Media access control
MC	Memory Card	Memory card in credit card format
MLFB	Machine-readable product designation	
MMC	Micro Memory Card	Memory card of the format 32 mm x 24.5 mm
MPI	Multipoint-capable interface for programming devices	
MS-DOS	Microsoft Disc Operating System	
MTBF	Mean Time Between Failures	
MUI	Multilanguage User Interface	Multilanguage operating system with Windows with language toggling; 5 languages: German, English, French, Spanish and Italian
NA	Not Applicable	

Abbreviation	Term	Meaning
NAMUR	Normenarbeitsgemeinschaft for Mess- und Regelungstechnik in der chemischen Industrie (standardization body for instrumentation and control technology in the chemicals industry)	
NC	Not Connected	Not connected
NCQ	Native Command Queuing	Automatic re-sorting of the file and disk access, for increased performance
NEMA	National Electrical Manufacturers Association	Syndicate of manufacturers of electrical components in the USA
NMI	Non Maskable Interrupt	Interrupt the processor can not reject
NTFS	New Techniques File System	Secure file system for Windows versions (2000, XP, 7)
NVRAM	Non Volatile Random Access Memory	Non-volatile data memory. Data memory is retained without external power supply.
ODD	Optical Disk Drive	
OPC	OLE for Process Control	Standardized interface for industrial processes
PATA	Parallel ATA	
PC	Personal computer	
PCI	Peripheral Component Interconnect	High-speed expansion bus
PCIe	Peripheral Component Interconnect express	High-speed serial, differential full-duplex PtP interface with high data rate.
PCMCIA	Personal Computer Memory Card International Association	
PE	Protective Earth	Protective conductor
PEG	PCI Express Graphics	
PG	Programming device	
PIC	Programmable Interrupt Controller	Programmable interrupt controller
PIC-E	Peripheral Component Interconnect Express	
POST	Power On Self Test	
PXE	Preboot Execution Environment	Software for running new PCs without hard disk data via the network
RAID	Redundant Array of Independent Disks	Redundant hard disk array
RAL	Restricted Access Location	Installation of device in operating facilities with restricted access - for example, a locked switch-gear cabinet
RAM	Random Access Memory	
RI	Ring Input	Incoming call
ROM	Read-Only Memory	
RS 485	Reconciliation Sublayer 485	Bi-directional bus system designed for up to 32 nodes
RTC	Real Time Clock	Real-time clock
RTS	Reliable Transfer Service	Request to send
RxD	Receive Data	Data transfer signal
SATA	Serial Advanced Technology Attachment	
SCSI	Small Computer System Interface	

Abbreviation	Term	Meaning
SDRAM	Synchronous DRAM	
SELV	Safety Extra Low Voltage	Safety extra low voltage
SLC	Second Level Cache	
SMART	Self Monitoring Analysis and Reporting Technology	Hard disk error diagnostics program
SMS	Short Message Service	Short message via telecommunication network
SNMP	Simple Network Management Protocol	Network protocol
SO-DIMM	Small Outline Dual Inline Memory Module	
SOM	SafeCard on Motherboard (SOM)	
SPP	Standard Parallel Port	Synonym for parallel port
SRAM	Static Random Access Memory	Static RAM
SSD	Solid State Drive	
SVGA	Super Video Graphics Array	Enhanced VGA standard with at least 256 colors
SVP	Serial number of the device	
SW	Software	
TCO	Total Cost of Ownership	
TFT	Thin-Film-Transistor	Type of LCD flat-screen
TPM	Trusted Platform Module	Chip with security functions
TTY	Tele Type	Asynchronous data transfer
TxD	Transmit Data	Data transfer signal
TXT	Trusted Execution Technology	Hardware implementation
TWD	Watchdog Time	Watchdog monitoring time
UEFI	Unified Extensible Firmware Interface	
UL	Underwriters Laboratories Inc.	US organization for tests and certifications according to own or binational standards (with CSA / Canada) standards.
UMA	Unified Memory Architecture	Video memory
URL	Uniform Resource Locator	Designation of the full address of an Internet page
USB	Universal Serial Bus	
UWF	Unified Write Filter	
UXGA	Ultra Extended Graphics Array	Graphic standard, maximum resolution 1600x1200 pixels.
V.24		ITU-T standardized recommendation for data transfer via serial ports
VCC		Positive supply voltage of integrated circuits
VDE	Verein deutscher Elektrotechniker (Union of German Electrical Engineers)	
VGA	Video Graphics Array	Video adapter which meets industrial standard
VRM	Voltage Regulator Module	
VT	Virtualization Technology	Intel technology with which a virtually closed environment can be made available.
VT-D	Virtualization Technology for Directed I/O	Enables the direct assignment of a device (e.g. network adapter) to a virtual device.

List of abbreviations

Abbreviation	Term	Meaning
W2k	Windows 2000	
WAN	Wide Area Network	
WAV	Wave Length Encoding	Loss-free file format for audio data
WD	Watchdog	Program monitoring with error detection and alarming.
WLAN	Wireless LAN	Wireless local area network
WoL	Wake on Local Area Network	
WWW	World Wide Web	
XD	Execute Disable Capability	Hardware implementation
XGA	Extended Graphics Array	Graphic standard, maximum resolution 1024x768 pixels.

Glossary

AHCI mode

AHCI is a standardized method to address the SATA controller. AHCI describes a structure in the RAM, which contains a general area for control and status, as well as a command list.

APIC mode

Advanced peripheral interrupt controller. 24 interrupt lines are available.

Automation system

A programmable controller (PLC) of the SIMATIC S7 system consist of a central controller, one or several CPUs, and various I/O modules.

Backup

Duplicate of a program, data medium or database, used either for archiving purposes or for the protection of vital and non-replaceable data against loss when the working copy is corrupted. Certain applications automatically generate backup copies of data files, and manage both the current and the previous versions on the hard disk.

Baud

Physical unit for the step speed in signal transmission. Defines the number of transferred signal states per second. With only two states, one baud is equivalent to a transmission rate of 1 bps.

Boot disk

A boot disk is a disk with a "Boot" sector. This can be used to load the operating system from the disk.

Cache

High-speed access buffer for interim storage (buffering) of requested data.

CE marking

Communauté Européene The CE mark confirms compliance of the product with corresponding EC Directives, for example, with the EMC Directive.

CFast card

CFast is a digital storage medium in card form without moving parts. A CFast card uses the SATA protocol and its connectors are not compatible with a classic CompactFlash card.

Chipset

Located on the motherboard, connects the processor with the PCI or PCIe bus and the external interfaces.

Cold restart

A start sequence, starting when the computer is switched on. The system usually performs some basic hardware checks within the cold start sequence, and then loads the operating system from the hard disk to work memory -> boot

COM interface

The COM interface is a serial V.24 interface. The interface is suitable for asynchronous data transfer.

Configuration files

These are files containing data which define the configuration after restart. Examples of such files are CONFIG.SYS, AUTOEXEC.BAT and the registry files .

Configuration software

The configuration software updates the device configuration when new modules are installed . This is done either by copying the configuration files supplied with the module or by manual configuration using the configuration utility.

Controller

Integrated hardware and software controllers that control the functions of certain internal or peripheral devices (for example, the keyboard controller).

Device configuration

The configuration of a PC or programming device contains information on hardware and device options, such as memory configuration, drive types, monitor, network address, etc. The data are stored in a configuration file and enable the operating system to load the correct device drivers and configure the correct device parameters. . If changes are made to the hardware configuration, the user can change entries in the configuration file using the SETUP program. .

Drivers

Program parts of the operating system. They adapt user program data to the specific formats required by I/O devices such as hard disk, printers, and monitors.

EMC directive

Directive concerning **E**lectromagnetic **C**ompatib**l**ity. Compliance is confirmed by the CE symbol and the EC certificate of conformity.

Energy management

The energy management functions of a modern PC allow individual control over the current consumption of vital computer components (e.g. of the monitor, hard disk and CPU), by restricting their activity based on the current system or component load. Energy management is of particular importance for mobile PCs.

Energy options

The energy options can be used to reduce energy consumption of the computer, while keeping it ready for immediate use. This can be configured in Windows by selecting Settings > Control Panel > Energy options.

Enhanced Write Filter

Configurable write filter that allows you to, for example, boot Windows Embedded Standard from write-protected media (e.g., CD-ROM), set write protection for individual partitions, and adapt the file system performance to user requirements (when using memory cards, for example).

ESD Guideline

Guideline for using electrostatic sensitive components.

Ethernet

Local network (bus structure) for text and data communication with a transfer rate of 10/100/1000 Mbps.

Execute Disable Capability

Hardware implementation that prevents mutual memory accesses by programs and applications. It is only effective when all relevant system components, such as processors, operating systems and applications are supported.

Extensible Firmware Interface

Refers to the central interface between the firmware, the individual components of a computer and the operating system. EFI is located logically beneath the operating system and represents the successor to PC BIOS, focusing on 64-bit systems.

File Based Write Filter

Configurable write filter to protect individual files from write access.

Formatting

Basic partitioning of memory space on a magnetic data medium into tracks and segments. Formatting deletes all data on a data medium. All data media must be formatted prior to their first use.

HORM

Hibernate once, resume many is a method for fast booting from a single Hibernate file that only needs to be created once. HORM ensures restoration of a uniform, saved system state when booting. This minimizes write access, for example to a CompactFlash medium, when you start up and shut down Windows Embedded Standard 7.

Hub

A term in network technology. In a network, a device joining communication lines at a central location, providing a common connection to all devices on the network.

Hyper Threading

HT technology (multi-threading) enables the parallel computing of processes. HT is only effective when all relevant system components, such as processors, operating systems and applications are supported.

IGD

Integrated Graphics Device. Graphics interface integrated in the chipset.

Image

This refers to the image, for example, of hard disk partitions saved to a file in order to restore them when necessary.

Intel Active Management Technology

This technology permits the diagnostics, management and remote control of PCs. It is only effective when all relevant system components, such as processors, operating systems and applications are supported.

Intel VT

The Intel Virtualization Technology (IVT) is the implementation of a secure closed environment for applications. Special (visualization) software on a VT-capable processor is required for its use.

Interface

- Physical interconnection (cable) of hardware elements such as PLCs, PCs, programming devices, printers or monitors.
- Interface for interactive software applications.

LAN

Local Area Network: LAN is a local network that consists of a group of computers and other devices that are distributed across a relatively restricted range and are linked with communication cables. The devices connected to a LAN are called nodes. The purpose of networks is the mutual use of files, printers or other resources.

Legacy Boot Device

Conventional drives can be used as USB devices.

License key

The license key represents the electronic license stamp of a license. Siemens provides the license keys for protected software.

License key disk

The license key disk contains the authorizations or license keys required to enable protected SIMATIC software.

Low-voltage directive

EC Product Safety Directive relating to the safety of products which are operated on low voltage (50 V AC to 1000 V AC, 70 V DC to 1500 V DC) and not specified in other directives. Compliance is confirmed by the CE symbol and the EC certificate of conformity.

Module

Modules are plug-in units for PLCs, programming devices or PCs. They are available as local modules, expansion modules, interfaces or mass storage (Mass storage module).

Motherboard

The motherboard is the core of the computer. Here, data are processed and stored, and interfaces and device I/Os are controlled and managed.

Operating system

Generic term which describes all functions for controlling and monitoring user program execution, distribution of system resources to the user programs and the operating mode in cooperation with the hardware (for example, Windows 7 Ultimate).

Pixel

The pixel represents the smallest element that can be reproduced on-screen or on a printer.

Plug&Play

Generally, a reference to the ability of a computer to automatically configure the system for communication with peripheral devices (for example monitors, modems or printers). The user can plug in a peripheral and "play" it at once without manually configuring the system. A Plug&Play PC requires both a BIOS that supports Plug&Play and a Plug&Play expansion card.

POST

Self-test performed by the BIOS after the computer is switched on. Performs a RAM test and a graphics controller test, for example. The system outputs audible signals (beep codes) if the BIOS detects any errors; the relevant message indicating cause of error is output on the screen.

Programmable controller

The programmable controllers of the SIMATIC S5 system consist of a central controller, one or several CPUs and various other modules (for example, I/O modules).

PXE server

A Preboot Execution Environment server is part of a network environment and can provide software to connected computers even before they boot. This can involve operating system installations or servicing tools, for example.

RAL

Restricted Access Location: Installation of the device in a production facility with restricted access, for example, a locked control cabinet.

Recovery function of the USB stick

Contains the tools for configuring hard disks and the Windows operating system.

Reset

Hardware reset: Reset/restart of the PC using a button/switch.

Restart

Warm restart of a computer without switching the power off (Ctrl + Alt + Del)

Restore function of the USB stick

The restore function is used to restore the system partition or the entire hard disk to factory state if the system has crashed. The USB stick contains all the necessary image files and is bootable.

ROM

Read-Only Memory ROM is a read-only memory in which every memory location can be addressed individually. The programs or data are permanently stored and are not lost in the event of a power failure.

S.M.A.R.T

The Self-Monitoring, Analysis and Reporting Technology (SMART or S.M.A.R.T.) is an industry standard integrated in storage media. It makes for permanent monitoring of important parameters and early detection of imminent problems.

SATA

Serial ATA Interface for hard disk drives and optical drives with serial data transmission rates of up to 300 Mbps.

SETUP (BIOS Setup)

A program in which information about the device configuration (that is the configuration of the hardware on the PC/PG) is defined. The device configuration of the PC/PG is preset with defaults. Changes must therefore be entered in the SETUP if a memory expansion, new modules or a new drive are added to the hardware configuration.

SSD (Solid State Drive)

A Solid State Drive is a drive that can be installed like any other drive; it does not contain a rotating disk or other moving parts because only semiconductor memory chips of similar capacity will be used. This design makes SSDs more rugged, provides shorter access times, low energy consumption and rapid data transfer.

STEP 7

Programming software for the creation of user programs for SIMATIC S7 controllers.

Troubleshooting

Error cause, cause analysis, remedy

Trusted Execution Technology

Hardware implementation that allows secured execution of programs and applications. It is only effective when all relevant system components, such as processors, operating systems and applications are supported.

Unified Write Filter

The Unified Write Filter is a configurable write filter that makes it possible to assign write protection to data storage media.

Wake on LAN

Wake on Local area network. This function allows the PC to be started via the LAN interface.

Warm restart

The restart of a computer after a program was aborted. The operating system is loaded and restarted again. The CTRL+ ALT+ DEL hotkey can be used to initiate a warm restart.

Index

A

- Abbreviations, 147, 152
- Adapting
 - Partitioning, 91
- Alarms
 - On the screen, 131
- Antivirus software, 48
- Approbation, 3
- Australia, 96
- Automatic Update, 48

B

- Battery monitoring, 52
- BIOS Setup, 124
 - Exit menu, 128
 - Menu layout, 126
- Boot sequence, 131
- Buffer memory, 106

C

- CAN
 - Base address register, 123
- CE marking, 3, 97
- Certificates, 97
 - Certifications and approvals, 95
- CFast card
 - Interface, 113
- COA label, 26
- Components sensitive to electrostatic charge, 98
- Condensation, 24
- Connecting
 - Peripherals, 35
 - Power supply, 38
 - Protective conductor, 37
- Connection elements, 13
- Creating an image, 93

D

- Data backup, 93
- Data exchange, 42
- Degree of protection, 105

Device

- opening, 62, 63
- Power on, 47
- DiagBase software, 49
- DiagMonitor
 - Temperature monitoring, 50
- DiagMonitor software, 49
- Diagnostics, 49, 49
 - DiagBase software, 49
 - DiagMonitor software, 49
 - Error messages, 131
 - Troubleshooting, 140
- Dimensions, 105
- Directive
 - ESD Directive, 98
- DisplayPort
 - Interface, 114
- Documentation and Drivers, 82
- Drives, 107

E

- Electromagnetic compatibility, 106
- Enable register
 - Watchdog, 121
- Enhanced Write Filter, 53
- Equipotential bonding, 37
- Error messages
 - Troubleshooting, 140
- ESD, 98
- ESD Directive, 98
- Ethernet, 42, 107
- Ethernet address, 25
- Ethernet interface, 115
- EU Declaration of Conformity, 97
- EWF (Enhanced Write Filter), 53
- Expansion slots, 106

F

- Factory state, 83
- FAQs, 140
- FBWF (File Based Write Filter), 56
- FCC, 96
- File Based Write Filter, 56
- Firewall, 48

H

Hard disk drive, 107

I

ICES, 96

Industrial Ethernet, 42

Initial commissioning, 47

Installation

Wall, 33

Installation of operating system

Windows, 84

Installing a memory module, 65

Installing language package, (See MUI)

Integration

Ethernet, 42

Interfaces

CFast card, 113

DisplayPort, 114

USB 3.0, 115

Interference emission, 106

IT communication, 42

K

Keyboard

Ports, 13

L

Labeling, 96

Korea, 96

License key, 83

Limitation of liability, 75

M

Main memory, 106

Marking

EU Declaration of Conformity, 97

Memory media

Drives, 107

Memory modules, 106

Monitoring functions, 49

Motherboard, 106

Mounting

Modules, 39, 69

MUI, 85

N

New Zealand, 96

Note

General Information, 21

NVRAM, 58

O

On-screen error messages, 131

Open

Device, 62, 63

Operating system

Initial commissioning, 47

Updates, 93, 93

P

Package contents, 23

Checking, 23

Packaging, 23

Checking, 23

Removing, 23

Partitioning

Adapting, 91

CFast card, 89

SSD, 89, 90

Windows 7 Ultimate, 90

Windows Embedded Standard 7, 89

Ports, 13, 107, 107

RJ45 Ethernet, 115

Power consumption, 105

Power supply

Connecting, 41

Processor, 106

PROFINET, 42

Protective conductor, 37

Connecting, 37

Protective measure

Static electricity, 100

R

Radiation, 19

High frequency radiation, 19

Recovery function, 81

Repairs, 73

Restore CD, 87

Restore function, 82

Restore function with Windows Embedded Standard, 83

S

- Safety information
 - Storage, 24
 - Transportation, 24
- Scope, 3
- Scope of application, 10
- Serial number, 25
- Setting up partitions
 - Windows 7, 85
- Setup, (BIOS Setup)
- SIMATIC NET, 42
- SSD
 - Partitioning, 89, 90
- Standard, 3
- Startup, 58, 131
- Static electricity
 - Protective measures, 100
- Strain relief, 31
- Supply voltage, 105
- System partition, 83
- System resources, 118

T

- Temperature monitoring, 50
- Third-party expansion cards, 141
- Trigger register
 - Watchdog, 122
- Troubleshooting/FAQs, 140

U

- Unified Write Filter, 52
- Update, 48
- Updates
 - Application programs and drives, 93
 - Operating system, 93, 93
- USB 3.0
 - Interface, 115
- User Account Control, 48
- UWF, 52

W

- Wall mounting, 33
- Warranty, 17
- Watchdog, 51
 - Enable register, 121
 - Monitoring function, 51

- Monitoring times, 51
 - Trigger register, 122
- Weight, 105
- Windows
 - Installation, 84
- Windows 7 Ultimate
 - Data backup, 93
 - Partitioning, 90
- Windows Action Center, 48
- Windows Embedded Standard
 - Data backup, 93
- Windows Embedded Standard 7
 - Setting up partitions, 89
- Windows XP Professional
 - Data backup, 93

