

Winder/Unwinder Application Software

Version: PID Control with Diameter Estimation

Model: 3G3RX/3G3MX2

CX-Drive Version: 2.9.3.20

USER'S MANUAL

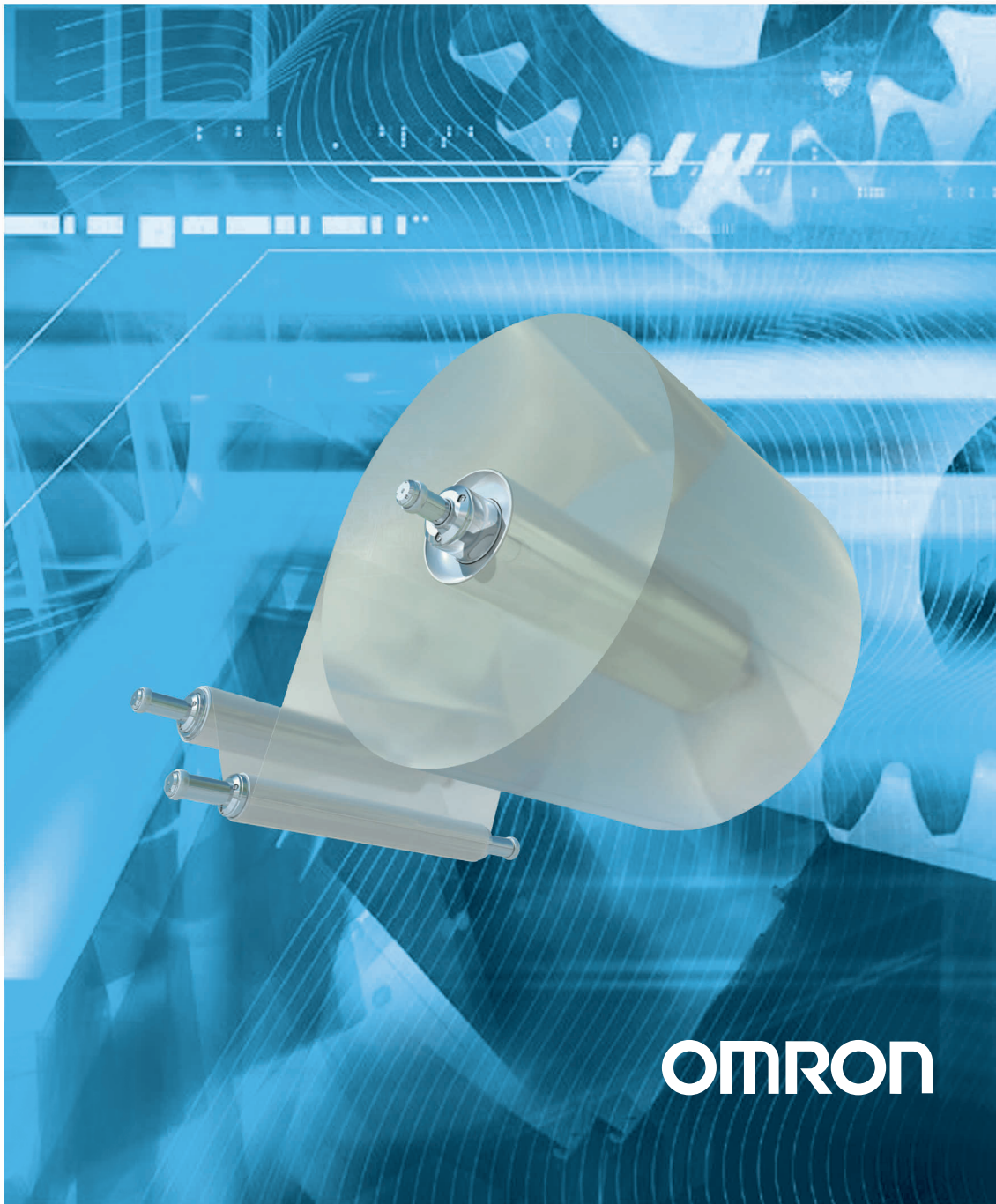

OMRON

Notice:

OMRON products are manufactured for use according to proper procedures by a qualified operator and only for the purposes described in this manual.

The following conventions are used to indicate and classify precautions in this manual. Always heed the information provided with them. Failure to heed precautions can result in injury to people or damage to property.

OMRON Product References

All OMRON products are capitalized in this manual. The word “Unit” is also capitalized when it refers to an OMRON product, regardless of whether or not it appears in the proper name of the product.

© OMRON, 2014

All rights reserved. No part of this publication may be reproduced, stored in a retrieval system, or transmitted, in any form, or by any means, mechanical, electronic, photocopying, recording, or otherwise, without the prior written permission of OMRON.

No patent liability is assumed with respect to the use of the information contained herein. Moreover, because OMRON is constantly striving to improve its high-quality products, the information contained in this manual is subject to change without notice. Every precaution has been taken in the preparation of this manual. Nevertheless, OMRON assumes no responsibility for errors or omissions. Neither is any liability assumed for damages resulting from the use of the information contained in this publication.

Winder/Unwinder Application Software

Read and Understand this Manual

Please read and understand this manual before using the product. Please consult your OMRON representative if you have any questions or comments.

Warranty and Limitations of Liability

WARRANTY

OMRON's exclusive warranty is that the products are free from defects in materials and workmanship for a period of one year (or other period if specified) from date of sale by OMRON.

OMRON MAKES NO WARRANTY OR REPRESENTATION, EXPRESS OR IMPLIED, REGARDING NON-INFRINGEMENT, MERCHANTABILITY, OR FITNESS FOR PARTICULAR PURPOSE OF THE PRODUCTS. ANY BUYER OR USER ACKNOWLEDGES THAT THE BUYER OR USER ALONE HAS DETERMINED THAT THE PRODUCTS WILL SUITABLY MEET THE REQUIREMENTS OF THEIR INTENDED USE. OMRON DISCLAIMS ALL OTHER WARRANTIES, EXPRESS OR IMPLIED.

LIMITATIONS OF LIABILITY

OMRON SHALL NOT BE RESPONSIBLE FOR SPECIAL, INDIRECT, OR CONSEQUENTIAL DAMAGES, LOSS OF PROFITS OR COMMERCIAL LOSS IN ANY WAY CONNECTED WITH THE PRODUCTS, WHETHER SUCH CLAIM IS BASED ON CONTRACT, WARRANTY, NEGLIGENCE, OR STRICT LIABILITY.

In no event shall the responsibility of OMRON for any act exceed the individual price of the product on which liability is asserted.

IN NO EVENT SHALL OMRON BE RESPONSIBLE FOR WARRANTY, REPAIR, OR OTHER CLAIMS REGARDING THE PRODUCTS UNLESS OMRON'S ANALYSIS CONFIRMS THAT THE PRODUCTS WERE PROPERLY HANDLED, STORED, INSTALLED, AND MAINTAINED AND NOT SUBJECT TO CONTAMINATION, ABUSE, MISUSE, OR INAPPROPRIATE MODIFICATION OR REPAIR.

Application Considerations

SUITABILITY FOR USE
<p>OMRON shall not be responsible for conformity with any standards, codes, or regulations that apply to the combination of products in the customer's application or use of the products.</p> <p>At the customer's request, OMRON will provide applicable third party certification documents identifying ratings and limitations of use that apply to the products. This information by itself is not sufficient for a complete determination of the suitability of the products in combination with the end product, machine, system, or other application or use.</p> <p>The following are some examples of applications for which particular attention must be given. This is not intended to be an exhaustive list of all possible uses of the products, nor is it intended to imply that the uses listed may be suitable for the products:</p> <ul style="list-style-type: none">• Outdoor use, uses involving potential chemical contamination or electrical interference, or conditions or uses not described in this manual.• Nuclear energy control systems, combustion systems, railroad systems, aviation systems, medical equipment, amusement machines, vehicles, safety equipment, and installations subject to separate industry or government regulations.• Systems, machines, and equipment that could present a risk to life or property. <p>Please know and observe all prohibitions of use applicable to the products.</p> <p>NEVER USE THE PRODUCTS FOR AN APPLICATION INVOLVING SERIOUS RISK TO LIFE OR PROPERTY WITHOUT ENSURING THAT THE SYSTEM AS A WHOLE HAS BEEN DESIGNED TO ADDRESS THE RISKS, AND THAT THE OMRON PRODUCTS ARE PROPERLY RATED AND INSTALLED FOR THE INTENDED USE WITHIN THE OVERALL EQUIPMENT OR SYSTEM.</p>

PROGRAMMABLE PRODUCTS
<p>OMRON shall not be responsible for the user's programming of a programmable product, or any consequence thereof.</p>

Disclaimers

CHANGE IN SPECIFICATIONS

Product specifications and accessories may be changed at any time based on improvements and other reasons.

It is our practice to change model numbers when published ratings or features are changed, or when significant construction changes are made. However, some specifications of the products may be changed without any notice. When in doubt, special model numbers may be assigned to fix or establish key specifications for your application on your request. Please consult with your OMRON representative at any time to confirm actual specifications of purchased products.

DIMENSIONS AND WEIGHTS

Dimensions and weights are nominal and are not to be used for manufacturing purposes, even when tolerances are shown.

PERFORMANCE DATA

Performance data given in this manual is provided as a guide for the user in determining suitability and does not constitute a warranty. It may represent the result of OMRON's test conditions, and the users must correlate it to actual application requirements. Actual performance is subject to the OMRON Warranty and Limitations of Liability.

ERRORS AND OMISSIONS

The information in this manual has been carefully checked and is believed to be accurate; however, no responsibility is assumed for clerical, typographical, or proofreading errors, or omissions.



Safety Precautions

- **Indications and meanings of safety information**









In this user's manual, the following precautions and signal words are used to provide information to ensure the safe use of the RX/MX2 Inverter.

The information provided here is vital to safety. Strictly observe the precautions provided.

- **Meanings of signal words**







 DANGER	<p>Indicates an imminently hazardous situation which, if not avoided, is likely to result in serious injury or may result in death. Additionally there may be severe property damage.</p>
 CAUTION	<p>Indicates a potentially hazardous situation which, if not avoided, may result in minor or moderate injury or in property damage.</p>

- **Alert symbols in this document**

 DANGER	
	<p>Turn off the power supply and implement wiring correctly. Not doing so may result in a serious injury due to an electric shock.</p>
	<p>Wiring work must be carried out only by qualified personnel. Not doing so may result in a serious injury due to an electric shock.</p>
	<p>Do not change wiring and slide switches (SW1), put on or take off Digital Operator and optional devices, replace cooling fans while the input power is being supplied. Doing so may result in a serious injury due to an electric shock.</p>
	<p>Be sure to ground the unit. Not doing so may result in a serious injury due to an electric shock or fire. (200-V class: type-D grounding, 400-V class: type-C grounding)</p>
	<p>Do not remove the terminal block cover during the power supply and 10 minutes after the power shutoff. Doing so may result in a serious injury due to an electric shock.</p>
	<p>Do not operate the Digital Operator or switches with wet hands. Doing so may result in a serious injury due to an electric shock.</p>
	<p>Inspection of the Inverter must be conducted after the power supply has been turned off. Not doing so may result in a serious injury due to an electric shock. The main power supply is not necessarily shut off even if the emergency shutoff function is activated.</p>



CAUTION

	<p>Do not connect resistors to the terminals (PD/+1, P/+, N/-) directly. Doing so might result in a small-scale fire, heat generation or damage to the unit.</p>
	<p>Install a stop motion device to ensure safety. Not doing so might result in a minor injury. (A holding brake is not a stop motion device designed to ensure safety.)</p>
	<p>Be sure to use a specified type of braking resistor/regenerative braking unit. In case of a braking resistor, install a thermal relay that monitors the temperature of the resistor. Not doing so might result in a moderate burn due to the heat generated in the braking resistor/regenerative braking unit. Configure a sequence that enables the Inverter power to turn off when unusual overheating is detected in the braking resistor/regenerative braking unit.</p>
	<p>The Inverter has high voltage parts inside which, if short-circuited, might cause damage to itself or other property. Place covers on the openings or take other precautions to make sure that no metal objects such as cutting bits or lead wire scraps go inside when installing and wiring.</p>
	<p>Do not touch the Inverter fins, braking resistors and the motor, which become too hot during the power supply and for some time after the power shutoff. Doing so may result in a burn.</p>
	<p>Take safety precautions such as setting up a molded-case circuit breaker (MCCB) that matches the Inverter capacity on the power supply side. Not doing so might result in damage to property due to the short circuit of the load.</p>
	<p>Do not dismantle, repair or modify this product. Doing so may result in an injury.</p>

Precautions for Safe Use

• Installation and storage

Do not store or use the product in the following places.

- Locations subject to direct sunlight.
- Locations subject to ambient temperature exceeding the specifications.
- Locations subject to relative humidity exceeding the specifications.
- Locations subject to condensation due to severe temperature fluctuations.
- Locations subject to corrosive or flammable gases.
- Locations subject to exposure to combustibles.
- Locations subject to dust (especially iron dust) or salts.
- Locations subject to exposure to water, oil, or chemicals.
- Locations subject to shock or vibration.

• Transporting, installation and wiring

- Do not drop or apply strong impact on the product. Doing so may result in damaged parts or malfunction.
- Do not hold by the front cover and terminal block cover, but hold by the fins during transportation.
- Do not connect an AC power supply voltage to the control input/output terminals. Doing so may result in damage to the product.
- Be sure to tighten the screws on the terminal block securely.
Wiring work must be done after installing the unit body.
- Do not connect any load other than a three-phase inductive motor to the U, V, and W output terminals.
- Take sufficient shielding measures when using the product in the following locations. Not doing so may result in damage to the product.
 - Locations subject to static electricity or other forms of noise.
 - Locations subject to strong magnetic fields.
 - Locations close to power lines.

• Operation and adjustment

- Be sure to confirm the permissible range of motors and machines before operation because the inverter speed can be changed easily from low to high.
- Provide a separate holding brake if necessary.
- If the Drive Programming stops during multi-function output, the output status is held. Take safety precautions such as stopping peripheral devices.
- If the clock command is used in Drive Programming, an unexpected operation may occur due to weak battery. Take measures such as detecting a weak battery by a check that the clock data returns to the initial setting and stopping the inverter or programs. When the LCD Digital Operator is removed or disconnected, Drive Programming is in a waiting status by the clock command.

• Maintenance and Inspection

- Be sure to confirm safety before conducting maintenance, inspection or parts replacement.
- The capacitor service life is influenced by the ambient temperature. Refer to “Smoothing Capacitor Life Curve” described in the manual. When a capacitor reaches the end of its service life and does not work as the product, you need to replace the capacitor.
- When disposing of LCD digital operators and wasted batteries, follow the applicable ordinances of your local government. When disposing of the battery, insulate it using tape.



The following display must be indicated when products using lithium primary batteries (with more than 6 ppb of perchlorate) are transported to or through the State of California, USA.

Perchlorate Material - special handling may apply.
See www.dtsc.ca.gov/hazardouswaste/perchlorate

The 3G3AX-OP05 has the lithium primary battery (with more than 6 ppb of perchlorate). Label or mark the above display on the exterior of all outer shipping packages of your products when exporting your products which the 3G3AX-OP05 are installed to the State of California, USA.

- Do not short + and –, charge, disassemble, heat, put into the fire, or apply strong impact on the battery. The battery may leak, explode, produce heat or fire. Never use the battery which was applied strong impact due to such as fall on the floor, it may leak.
- UL standards establish that the battery shall be replaced by an expert engineer. The expert engineer must be in charge of the replacement and also replace the battery according to the method described in this manual.
- When the display of LCD Digital Operator can not be recognized due to the service life, replace the LCD Digital Operator.

Precautions for Correct Use

- **Installation**

- Mount the product vertically on a wall with the product's longer sides upright.
The material of the wall has to be nonflammable such as a metal plate.

- **Main circuit power supply**

- Confirm that the rated input voltage of the Inverter is the same as AC power supply voltage.

- **Error Retry Function**

- Do not come close to the machine when using the error retry function because the machine may abruptly start when stopped by an alarm.
- Be sure to confirm the RUN signal is turned off before resetting the alarm because the machine may abruptly start.

- **Non-stop function at momentary power interruption**

- Do not come close to the machine when selecting restart in the non-stop function at momentary power interruption selection (b050) because the machine may abruptly start after the power is turned on.

- **Operation stop command**

- Provide a separate emergency stop switch because the STOP key on the Digital Operator is valid only when function settings are performed.
- When checking a signal during the power supply and the voltage is erroneously applied to the control input terminals, the motor may start abruptly. Be sure to confirm safety before checking a signal.

- **Product Disposal**

- Comply with the local ordinance and regulations when disposing of the product.

Warning labels

Warning labels are located on the inverter as shown in the following illustration. Be sure to follow the instructions.

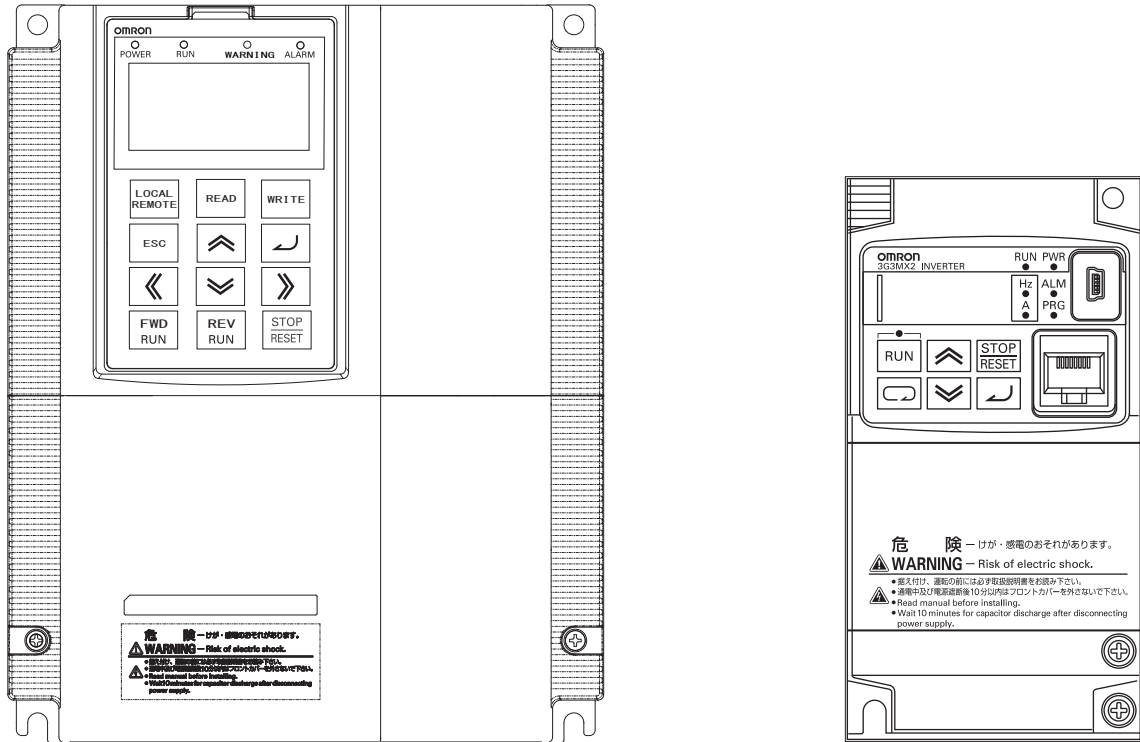

Warning description

危険 — けが・感電のおそれがあります。

WARNING — Risk of electric shock.

- 据え付け、運転の前には必ず取扱説明書をお読み下さい。
- 通電中及び電源遮断後10分以内はフロントカバーを外さないで下さい。
- Read manual before installing.
- Wait 10 minutes for capacitor discharge after disconnecting power supply.

Checking Before Unpacking

- **Checking the product**

- On delivery, be sure to check that the delivered product is the Inverter 3G3RX/3G3MX2 model that you ordered. Should you find any problems with the product, immediately contact your nearest local sales representative or OMRON sales office.

- **Checking the nameplate (3G3RX)**

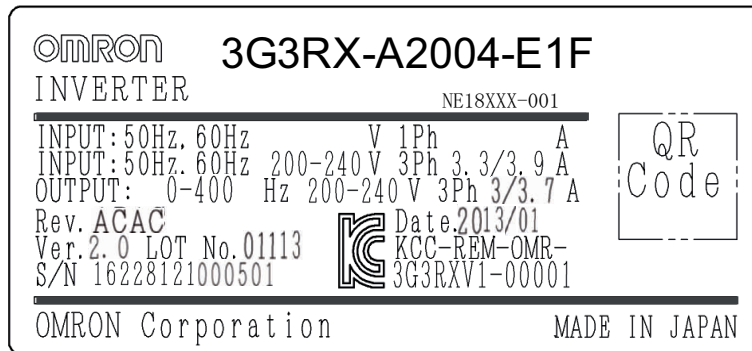

- **Checking the nameplate (3G3MX2)**

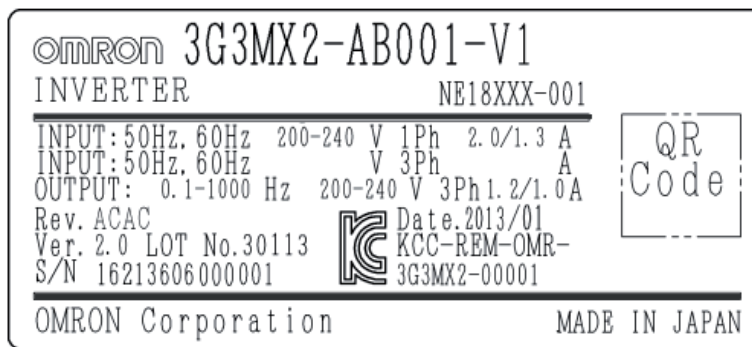

• Checking the model (3G3RX)

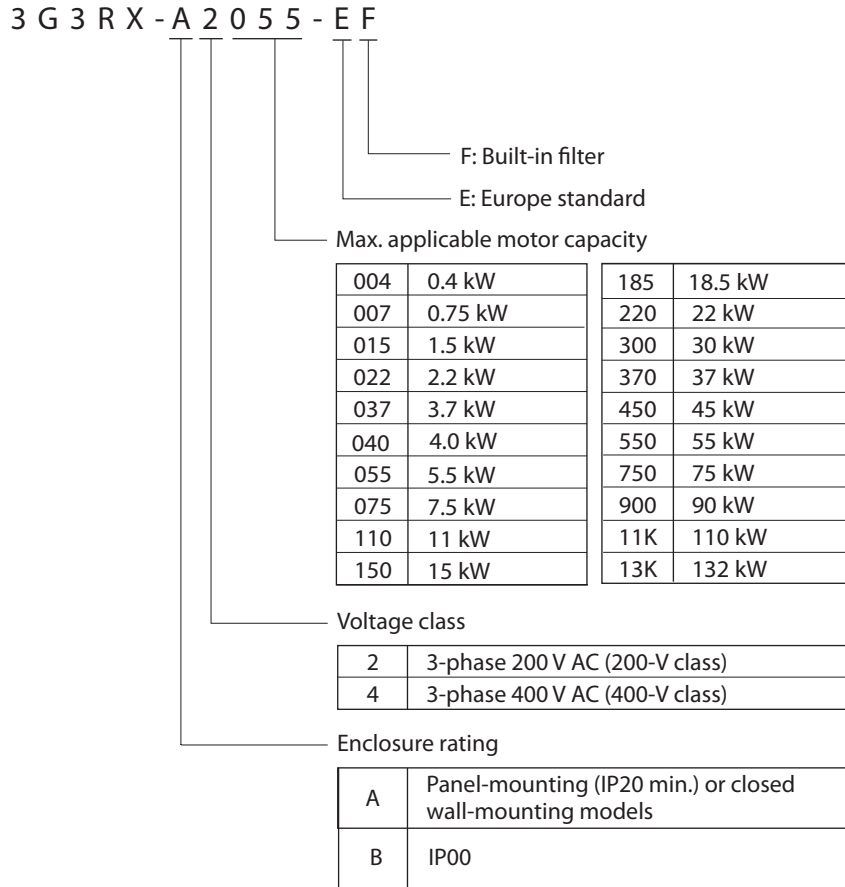

• Checking the model (3G3MX2)

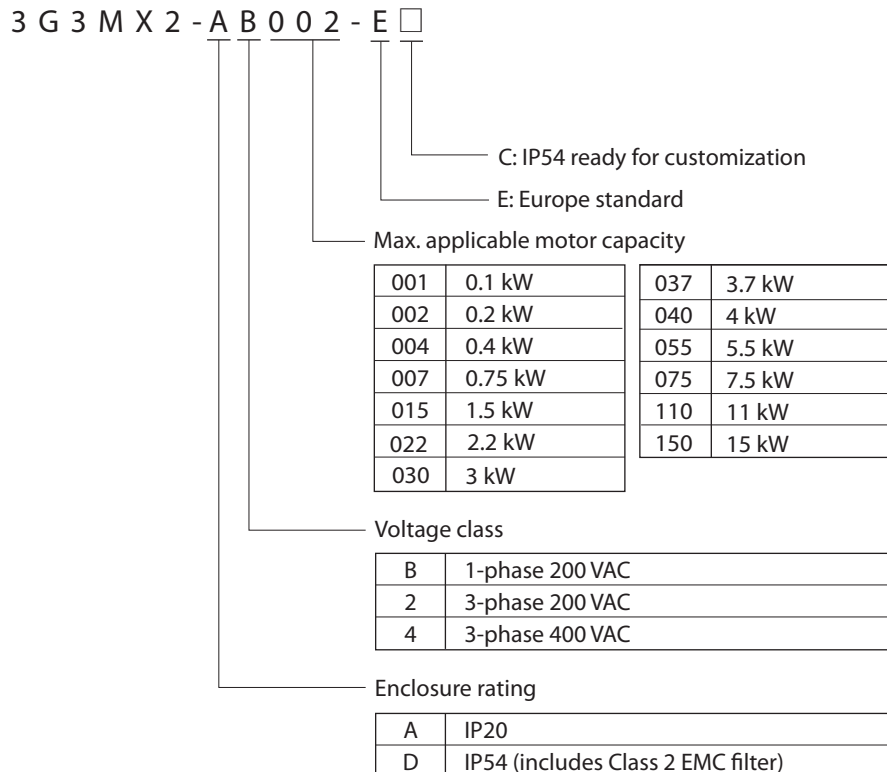

Revision History

- A manual revision code appears as a suffix to the catalogue number located at the lower left of the front and back covers.

Cat. No. I213E-EN-01

↑ Revision code

Revision code	Revision date	Description
01	April 2014	Original production
01A	October 2014	P113 parameter description was modified
02	June 2015	d025, d026 and d027 parameters name and description were modified

Related Manuals

Cat. No.	Description
I560-E2	RX User's Manual
I130E-EN	RX Quick Start Guide
I570-E2	MX2 User's Manual
I129E-EN	MX2 Quick Start Guide
I579-E2	LCD Digital Operator User's Manual
I580-E2	MX2/RX/LX Drive Programming User's Manual

Winder/Unwinder Application Software

1 OVERVIEW	17
1.1 Introduction	17
1.2 Handling of this user's manual	17
1.3 Safety instruction	17
1.4 Advantages using the application software	18
1.5 Application diagram	18
1.6 Terminology	18
2 PREPARATION AND SYSTEM CONFIGURATION	19
2.1 Installation and power circuits	19
2.2 DIP-SWITCH	19
2.3 Connection diagram	20
2.4 Encoder connection 3G3AX-PG Board (Only for 3G3RX inverter)	22
3 APPLICATION CONFIGURATION STEPS	23
3.1 Motor autotuning	23
3.2 Parameter settings and Drive Programming application	24
4 DRIVE PROGRAMMING PARAMETERS	31
4.1 Application configuration	31
4.2 Application software parameters	32
4.3 Inputs/outputs	33
4.4 Monitor parameters	33
4.5 Error codes	34
4.6 Other relevant parameters	34
5 WINDER/UNWINDER APPLICATION FUNCTIONS	35
5.1 Taper function	35
5.2 Preset function timing diagram	36
5.3 Freeze function timing diagram	37
5.4 Reset function timing diagram	38
5.5 Diameter completion function	39
5.6 Dynamic PID function	40

Winder/Unwinder Application Software

1 OVERVIEW

1.1 Introduction

This user's manual explains how to use the Winder/Unwinder Application program for 3G3RX/3G3MX2 inverter. Be sure to read this user's manual carefully before using this Winder/Unwinder Application program, and keep it on hand for further reference.

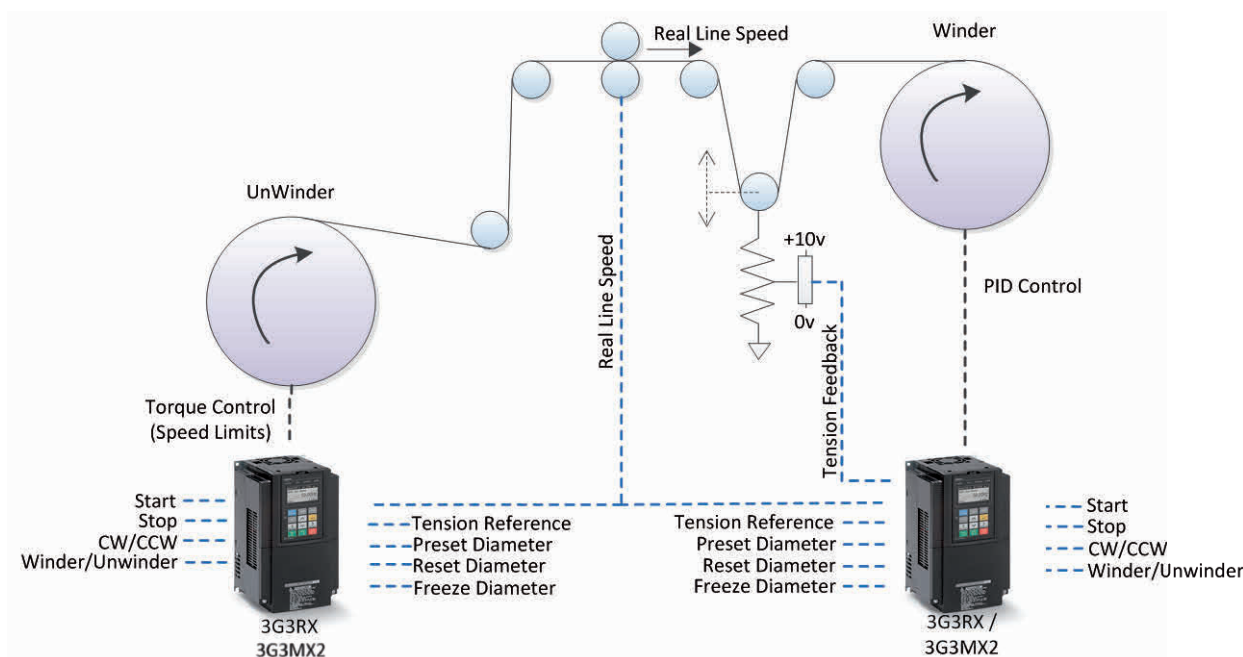

Note: In this specific Winder/Unwinder Application program, the line speed is given through the analog input O2 (RX)/OI (MX2) and the tension feedback through analog input O.

1.2 Handling of this user's manual

The contents of this user's manual are subject to change without prior notice. No part of this user's manual may be reproduced in any form without the publisher's permission.

If you find any incorrect description, missing description or have questions concerning the contents of this user's manual, please contact the publisher.

1.3 Safety instruction

Be sure to read this user's manual, inverter user's manual, and appended documents thoroughly before using Winder/Unwinder Application program and the inverter. Ensure you to understand and follow all safety information, precautions, and operating and handling instructions for the correct use of the inverter. Always use the inverter strictly within the range of specifications described in the inverter user's manual and correctly implement maintenance and inspection to prevent fault from occurring. When using the inverter together with optional products, also read the manual of those products. Note that this user's manual and the manual for each optional product to be used should be delivered to the end user of the inverter. In this user's manual you can find WARNING along the instruction WARNINGS: indicates that incorrect handling may cause hazardous situation, which may result in serious personal injury or death.

1.4 Advantages using the application software

Functions supported in this application software:

Control mode

- In this specific application case software, winder tension is controlled by RX/MX2 standard PID control (dancer/load cell).

Diameter sensor/calculation

- A sensor for diameter measurement is not needed.
- Diameter reset, preset and freeze functionality.

Tension profile/taper function

- 3-point tension profile to decrease tension by growing diameter.

Special digital output functions

- Winding job finished (job completion).

Other features

- Change between winder and unwinder by digital input.
- Line speeds up to 600m/min supported.
- Diameter monitor.
- Dynamic PID (proportional).

1.5 Application diagram

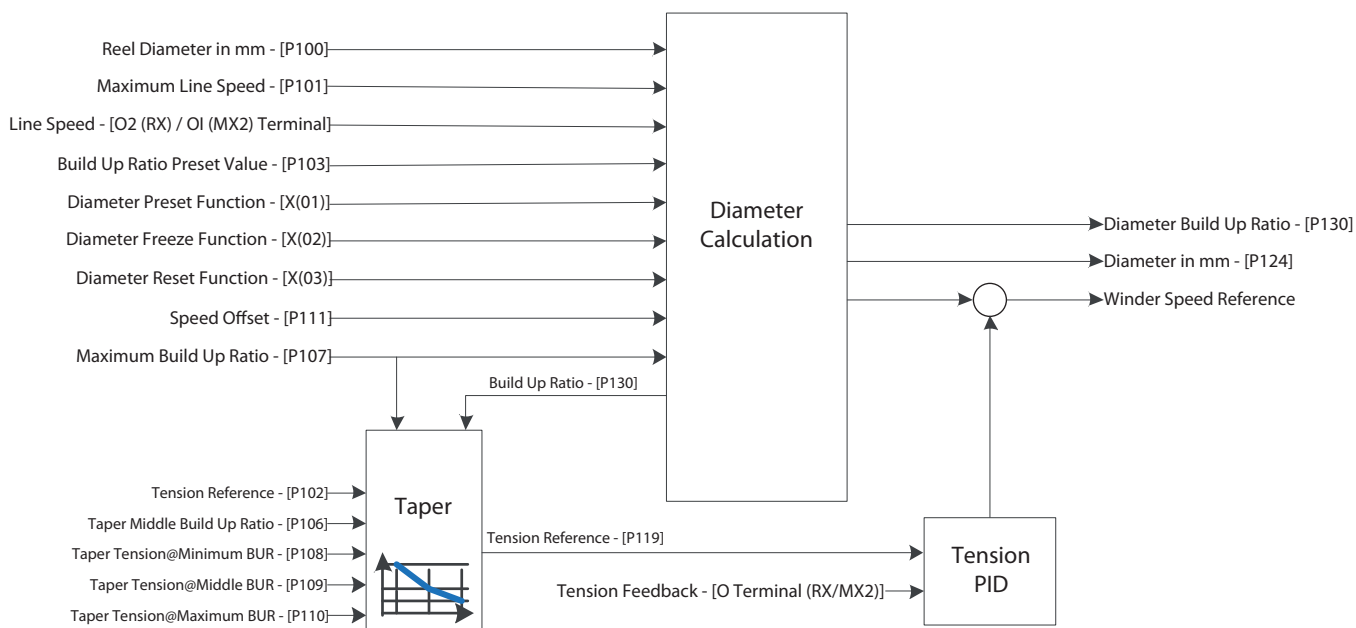

1.6 Terminology

Concept	Description
Build Up Ratio (BUR)	Is the ratio between reel diameter and maximum diameter, considering for reel diameter the value 1. For instance, an application in which reel diameter is 90mm and maximum diameter is 900mm, the ratio is 10, so: $BUR = (\text{maximum diameter}/\text{reel diameter}) = 900\text{mm}/90\text{mm} = 10$

Note: In this application software the Build Up Ratio is scaled by 1000. So, in the last example, the minimum build up ratio (reel diameter) used internally is 1000 (= 1 * 1000) and for the maximum diameter we will use 10000 (= 10 * 1000). It is needed to multiply by 1000 the calculated Build Up Ratio (BUR).

2 PREPARATION AND SYSTEM CONFIGURATION

To prepare the inverters for operation, the configuration tool CX-Drive is used for setting parameters and to download the Winder/Unwinder Application program. In the following chapters we will show the necessary steps to set up the inverter for a winder/unwinder application. We will use 3G3RX/3G3MX2 inverter.

2.1 Installation and power circuits

This manual does not cover how to install the inverters in cabinets, how to wire power supply or how to satisfy other application specific requirements. Please, refer to the RX User's Manual (I560-E2) or MX2 User's Manual (I570-E2).

2.2 DIP-SWITCH

3G3RX DIP-SWITCH

There is only one switch in 3G3RX. If the switch is ON, digital input 1 and 3 are configured as emergency shutoff inputs.

Factory setting is OFF, so just check that the switch is really OFF.

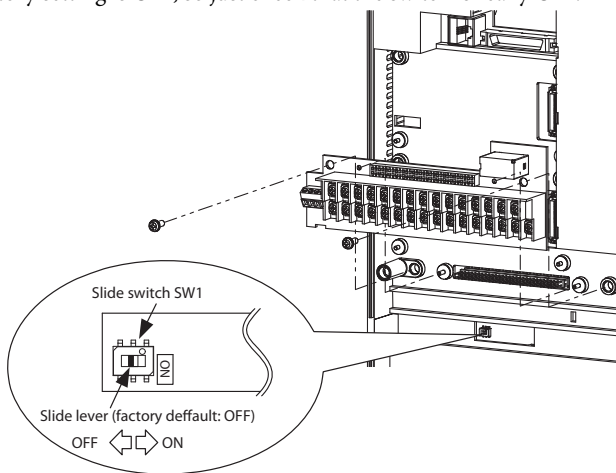

3G3MX2 DIP-SWITCHES

The switches in MX2 are small and can be difficult to discover. They are located just above the control logic connectors.

MDSW1 is related to RS485 communication and connects a built in 200_termination resistor. In this application it should be switched ON in both inverters.

SFSW1 is for configuring digital inputs 3 and 4 as safety inputs. This needs to be OFF.

EDMSW1 is also related to safety, and configures digital output 11 as EDM output (External Device Monitoring). This needs to be OFF.

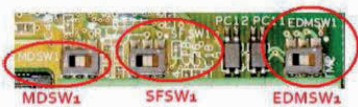

Make sure both SFSW1 and EDMSW1 are OFF, i.e. in the left most position:

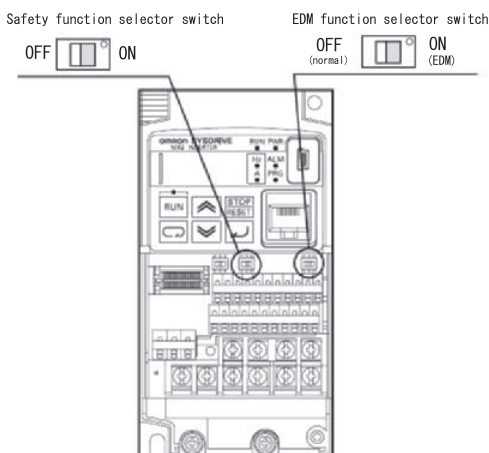

2.3 Connection diagram

3G3RX connection diagram

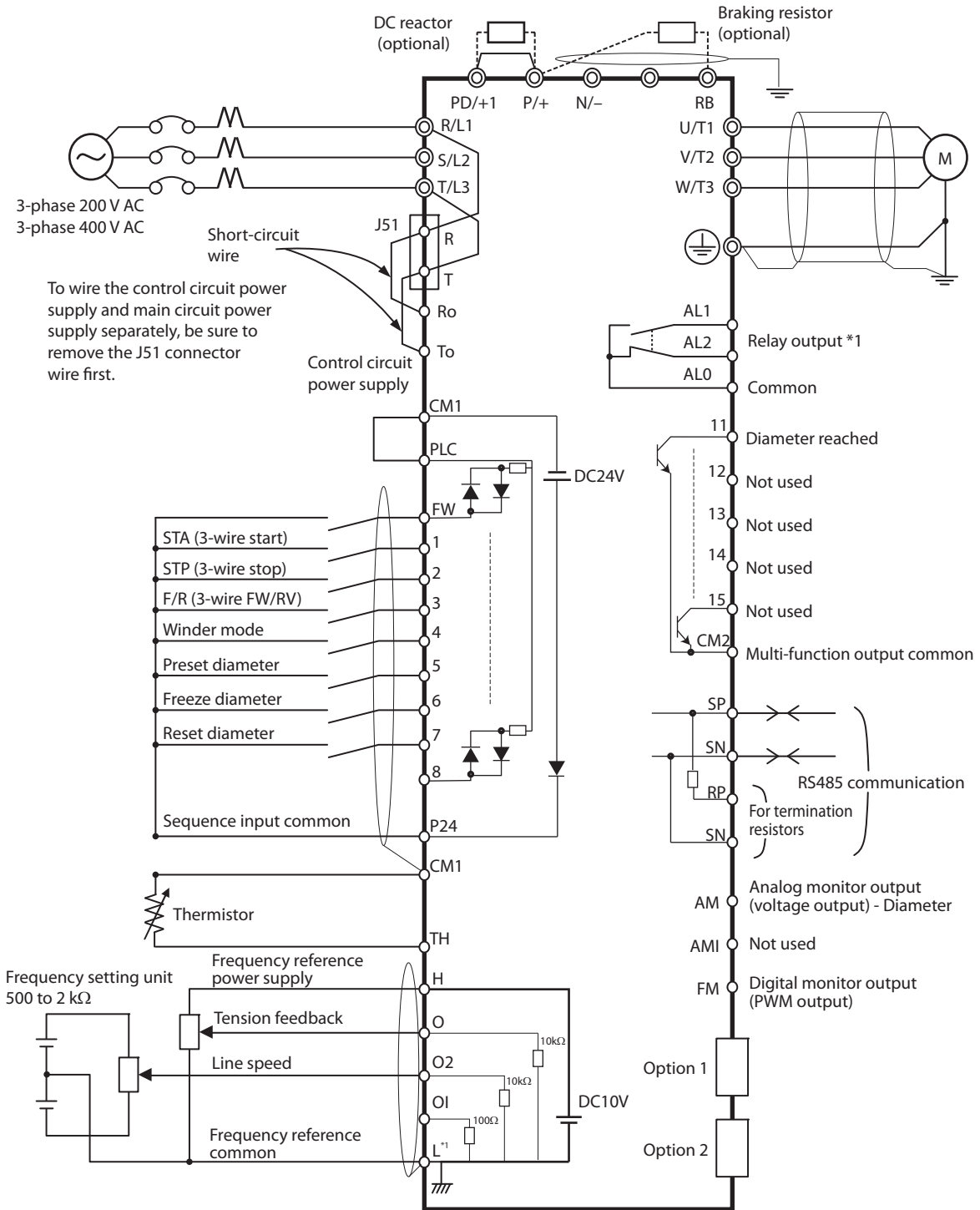

¹ L is the common reference for analog input and also for analog output.

3G3MX2 connection diagram

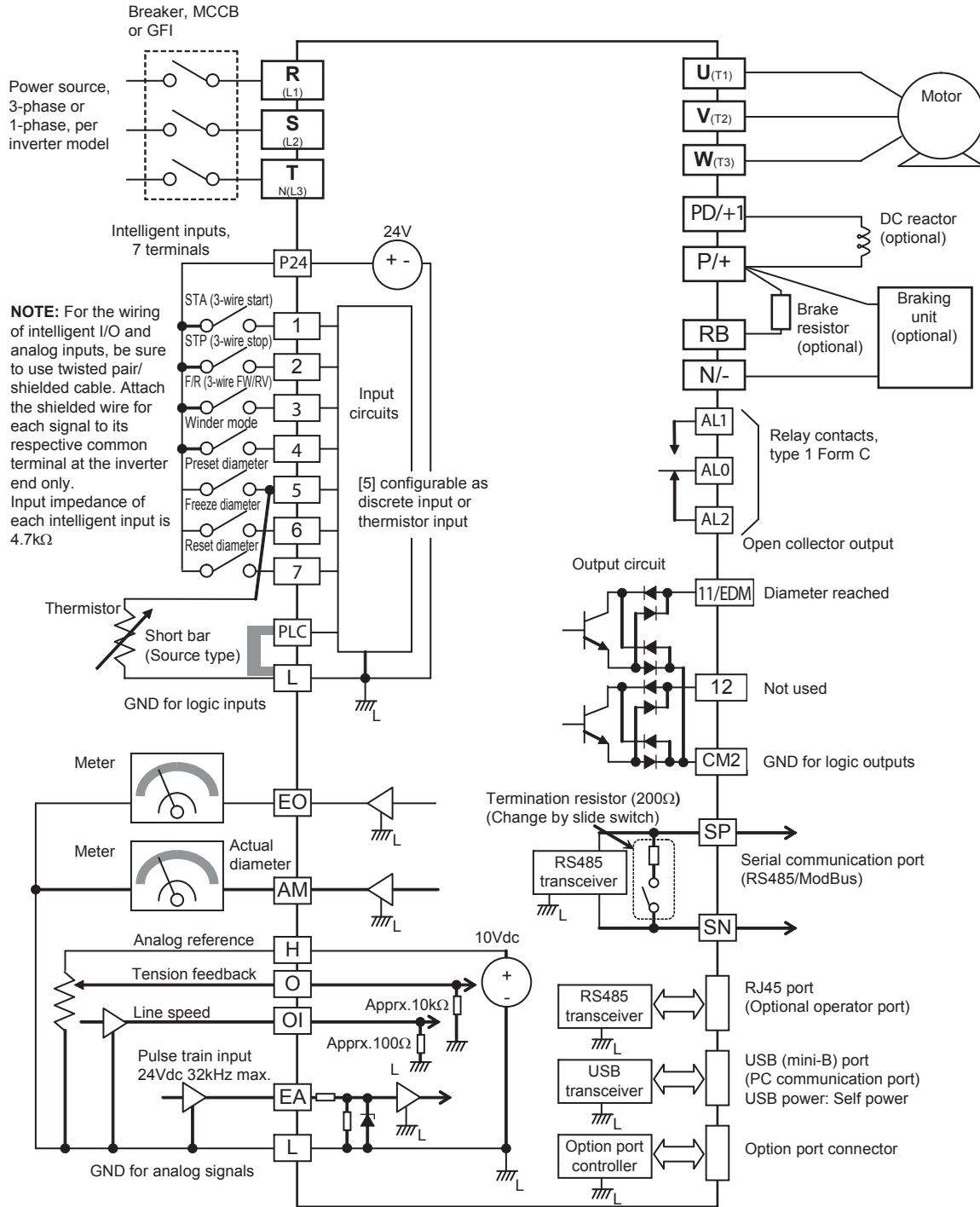

2.4 Encoder connection 3G3AX-PG Board (Only for 3G3RX inverter)

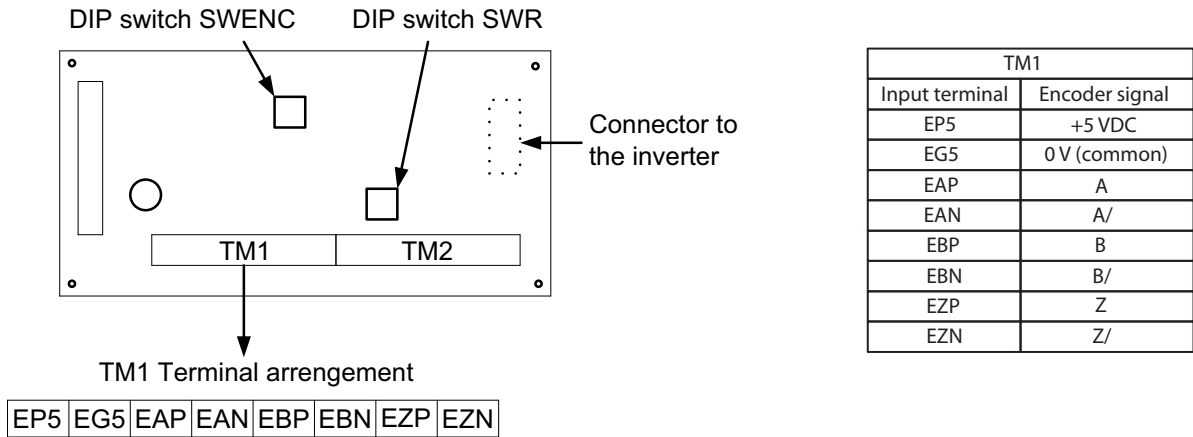

Switch arrangement

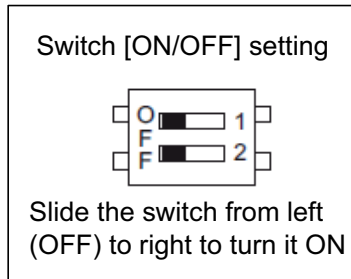

Default settings

The default settings (factory settings) are shown below:

DIP switch name	Switch No.	Settings		Default settings
SWENC	1	ON	Disconnection detection enabled when encoder A and B phases are not connected.	OFF
		OFF	Disconnection detection disabled when encoder A and B phases are not connected.	
	2	ON	Disconnection detection enabled when encoder Z phase is not connected.	OFF
		OFF	Disconnection detection disabled when encoder Z phase is not connected.	
SWR ^{*1}	1	ON	Built-in termination resistor between SAP and SAN (150 Ω) enabled	OFF
		OFF	Built-in termination resistor between SAP and SAN disabled	
	2	ON	Built-in termination resistor between SBP and SBN (150 Ω) enabled	OFF
		OFF	Built-in termination resistor between SBP and SBN disabled	

*1. When connecting to multiple units in parallel for pulse train position command inputs, turn ON the SWR1 and SWR2 of the only one unit located farthest from the master unit.

3 APPLICATION CONFIGURATION STEPS

3.1 Motor autotuning

1. Introduce motor settings:

Par. No.	Name	Value
A003	Base frequency	Motor base frequency (Hz)
A044	V/f characteristics selection	05: V2 (Sensor vector control)
b012	Electronic thermal level	Motor rated current
H002	Motor parameter selection	01: Auto-tuning parameter
H003	Motor capacity selection	Introduce motor capacity (kW)
H004	Motor pole number selection	Introduce motor pole number
P011 (RX)	Encoder pulses	Introduce number of encoder pulses per revolution (ppr)

Before starting the auto-tuning set parameter A051 (DC injection braking selection) to disable.

2. After introducing motor parameter settings, set H001 = 01: Static or 02: Rotate and turn on the run command. It will start the motor auto-tuning.



Note: It is recommended to use option 02: rotate autotuning. Please, be sure that the shaft is free (no gear/run connected).

Once the auto-tuning process is finished it will appear a message indicating if the auto-tuning is ok or not.

(1) Auto-tuning OK: Change A051 (DC injection braking selection) again to enable.

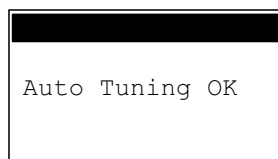

(2) Auto-tuning NOK: Verify introduced motor settings. For further information, please refer to the RX/MX2 user's manual.

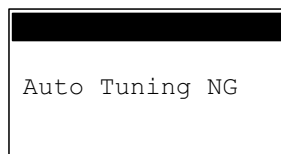

Note: After complete the auto-tuning process, be sure that with Run FW signal the motor shaft is rotating CW (clock wise).

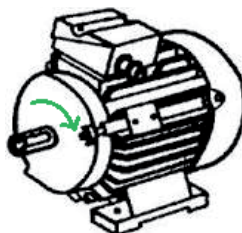

3.2 Parameter settings and Drive Programming application

After finishing the autotuning process, follow next steps in order to upload inverter parameter settings with CX-Drive tool, download the winder/unwinder application case software and save the project:

1. Open CX-Drive.  CX-Drive
2. **3G3RX:** Connect your computer USB port to the RJ-45 3G3RX inverter port with 3G3AX-PCACN2 cable or USB-CONVERTERCABLE. Remove the LCD Digital Operator to access RJ-45 port:

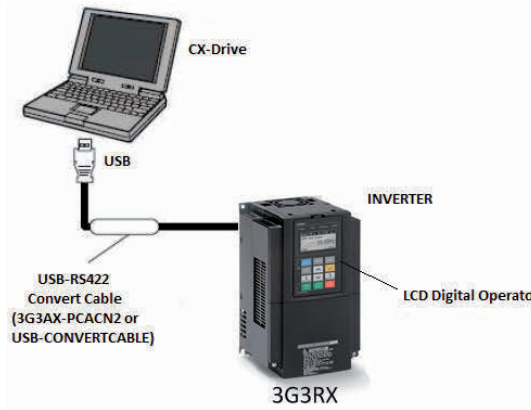

3G3MX2: Use the standard mini-USB cable to connect your PC with the 3G3MX2 inverter.

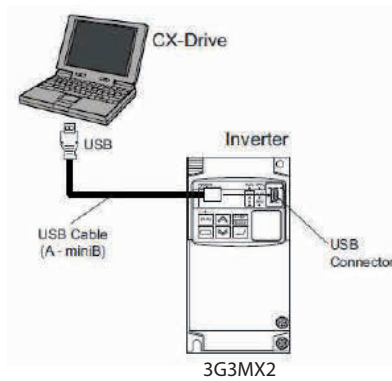

3. Use the CX-Drive autodetect  function in order to go online with the 3G3RX/3G3MX2 inverter:

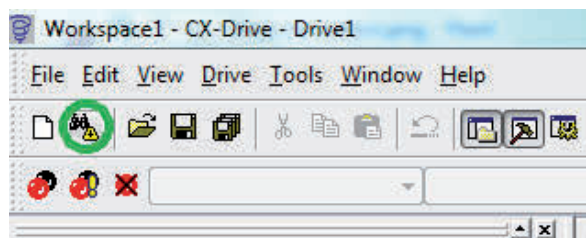

APPLICATION CONFIGURATION STEPS

4. A new dialog will appear for autodetect function, trying to connect with 3G3RX/3G3MX2 inverter:

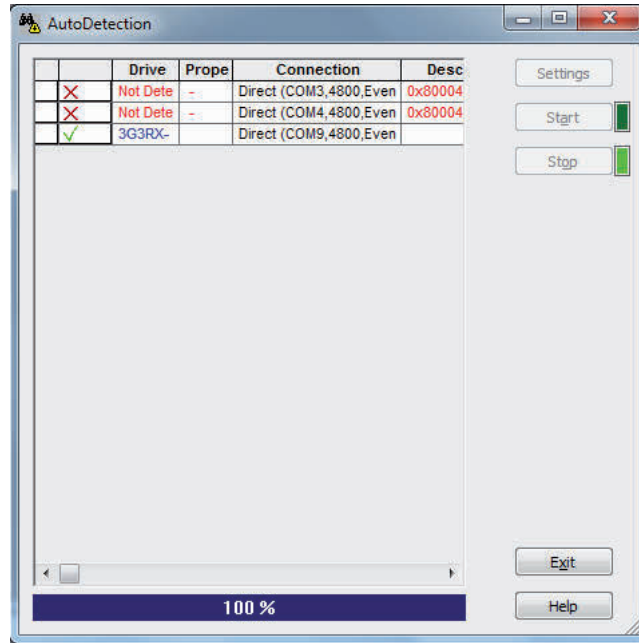

5. After detecting the inverter, automatically a new project will be created (in online mode) in the CX-Drive:

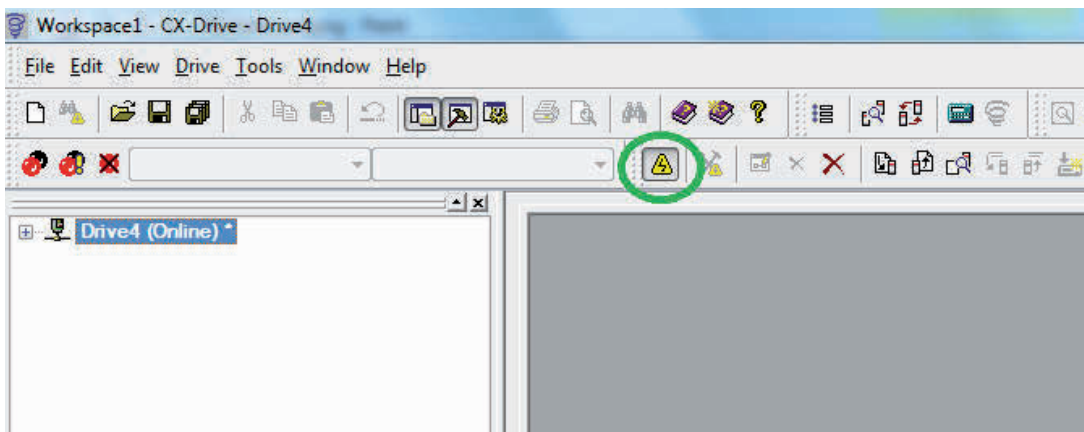

6. Press mouse right button if you want to change the Drive name. A new dialog will appear:

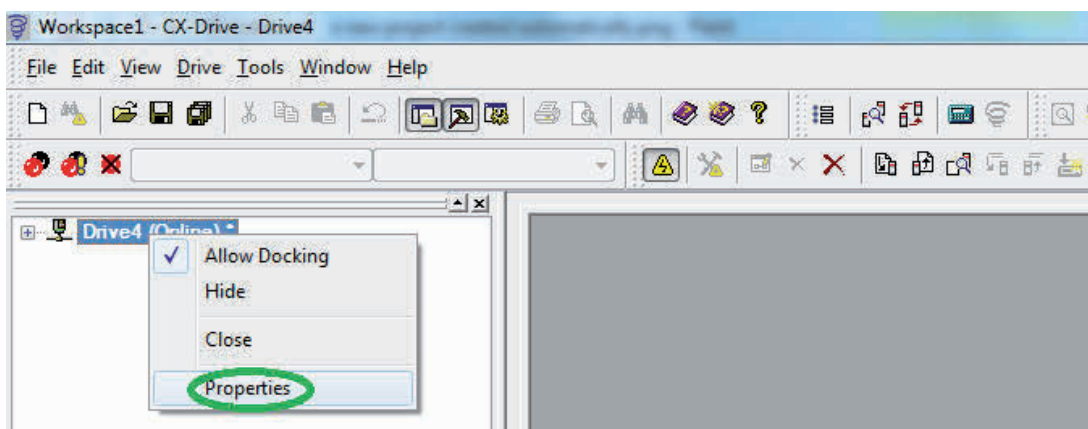

7. Introduce the Drive name and press OK button:

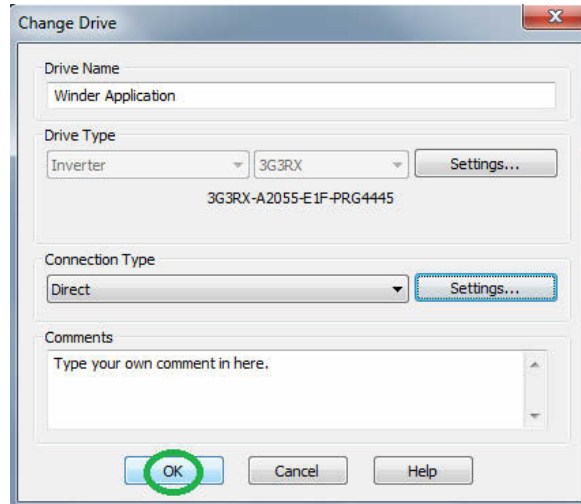

8. The new name will be updated in the project tree:

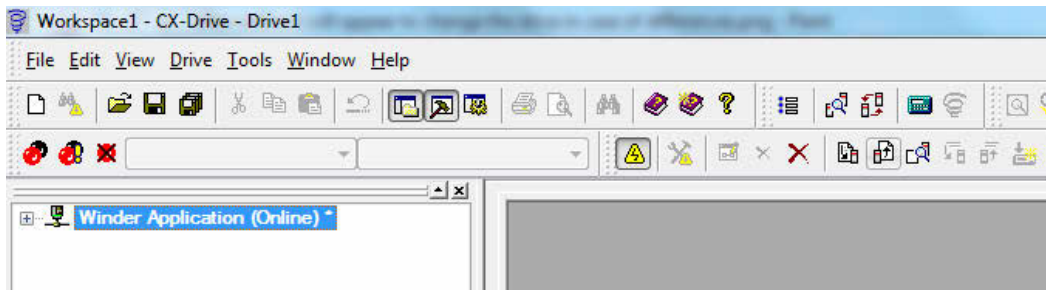

9. Upload inverter parameters clicking the  icon.



A new dialog will appear. Select only Drive Parameter and press ok:

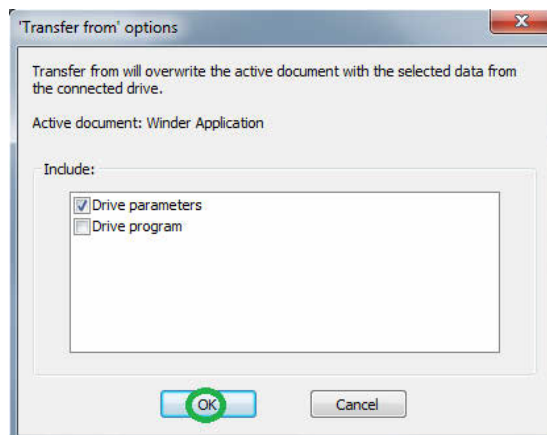

After pressing ok, the parameters will start to be transferred:

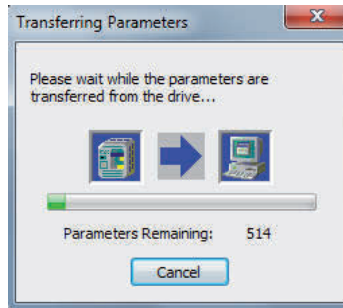

Once the parameters have been downloaded, a new message window will appear indicating that parameter have been transferred successfully:

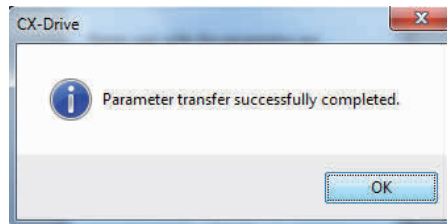

10. Import the Drive Programming case application software. Go to *File -> Import*:

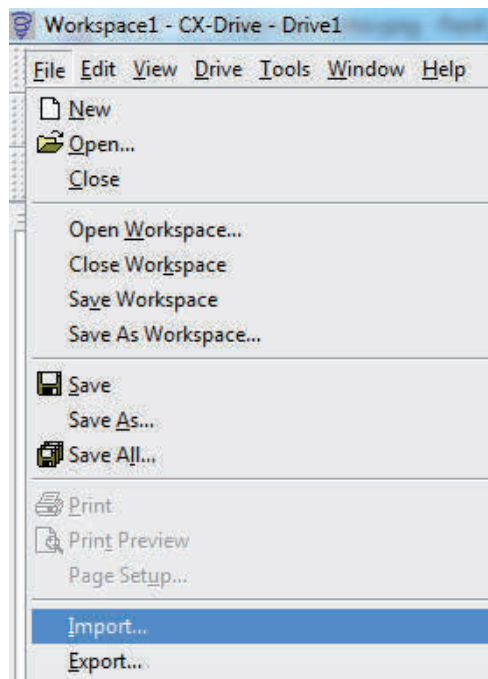

Go to the folder where you have the “.driveprogram” file. Select the file and press Open button:

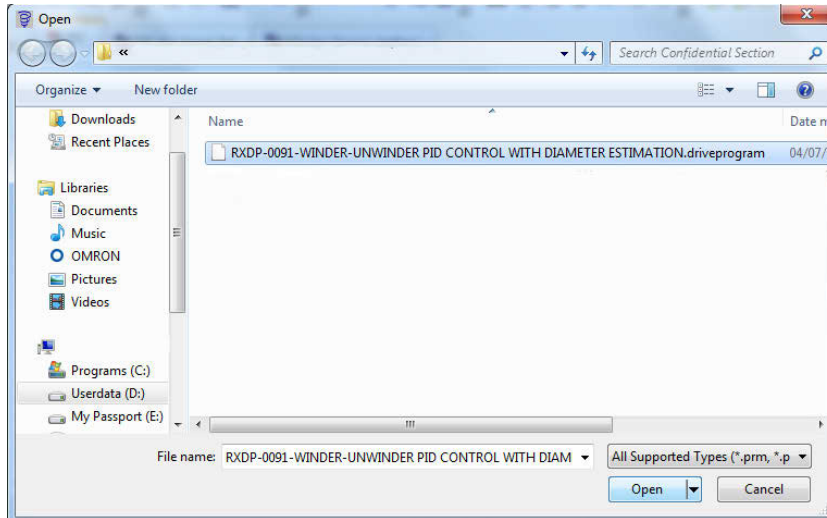

11. In the project tree go to the section Drive Programming with double-click:

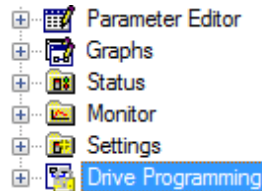

12. A message will appear requesting an access code. Press cancel button:

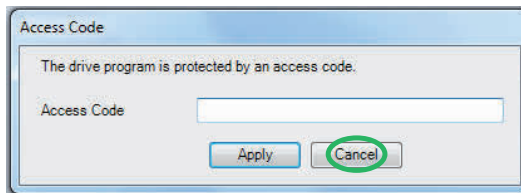

Note: It will be showed the DP section without DP winder application source code.

13. Compile the program and verify in the output window that the program size is not 0 bytes:

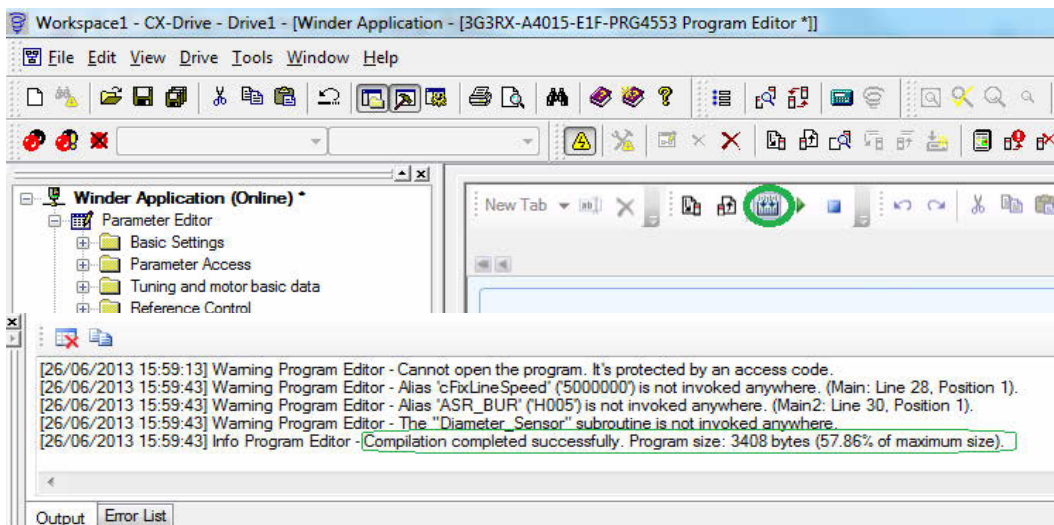

APPLICATION CONFIGURATION STEPS

14. Download Drive Programming program by pressing the download icon  in the Drive Programming section:

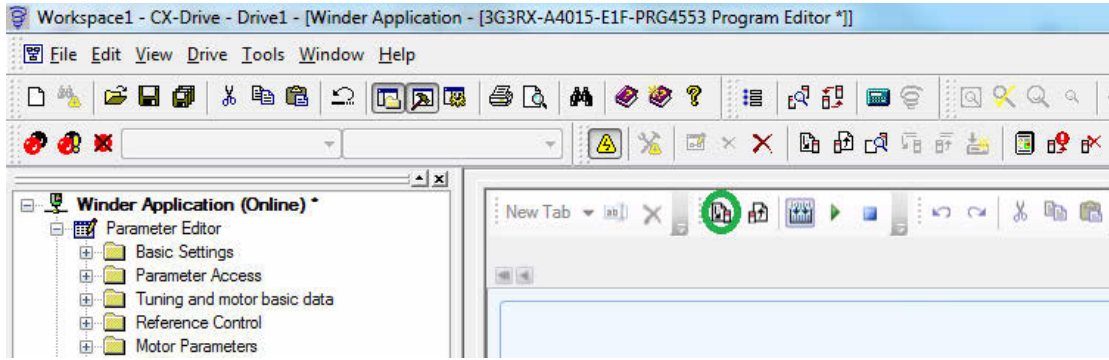

A new dialog will appear showing the status of the downloading process:

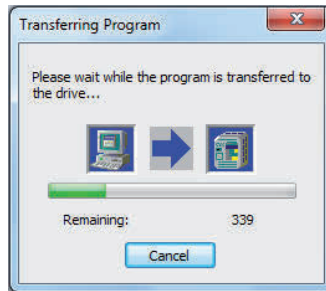

After downloading a new message box will appear indicating that the program has been down loaded with success. Press ok button:

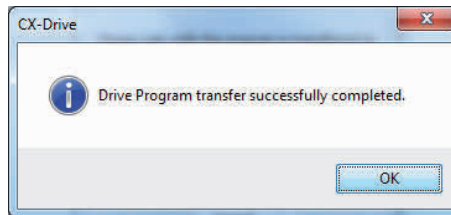

15. After downloading the DP program, press the Start  program button, or set parameter A017 (Drive programming (EzSQ) selection) to 02: Always ON.

16. Go to the Status -> Drive Programming section and verify that Tasks are running:

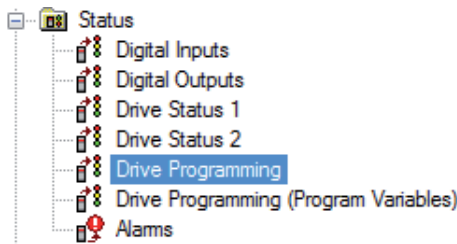

Double-click in the Status -> Drive Programming section:

<input checked="" type="checkbox"/>	T1S	Status of task #1	1: Running
<input checked="" type="checkbox"/>	T2L	Current execution step of task #2	2
<input checked="" type="checkbox"/>	T2S	Status of task #2	1: Running
<input checked="" type="checkbox"/>	T3L	Current execution step of task #3	0
<input checked="" type="checkbox"/>	T3S	Status of task #3	1: Running
<input checked="" type="checkbox"/>	T4L	Current execution step of task #4	0
<input checked="" type="checkbox"/>	T4S	Status of task #4	0: Not started
<input checked="" type="checkbox"/>	T5L	Current execution step of task #5	0
<input checked="" type="checkbox"/>	T5S	Status of task #5	0: Not started
<input checked="" type="checkbox"/>	TNUM	Number of tasks	2

Note: This Winder Application software version is using task#1, task#2 and task#3. So, verify that three tasks are running.

17. Save your project. Go to *File -> Save As...* option:

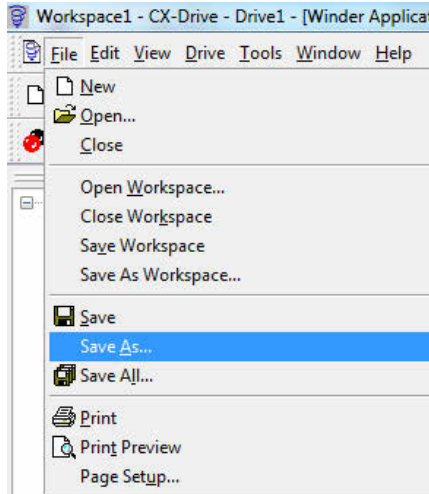

A new dialog will appear. Put the file name that you want for the project and press the “Save” button:

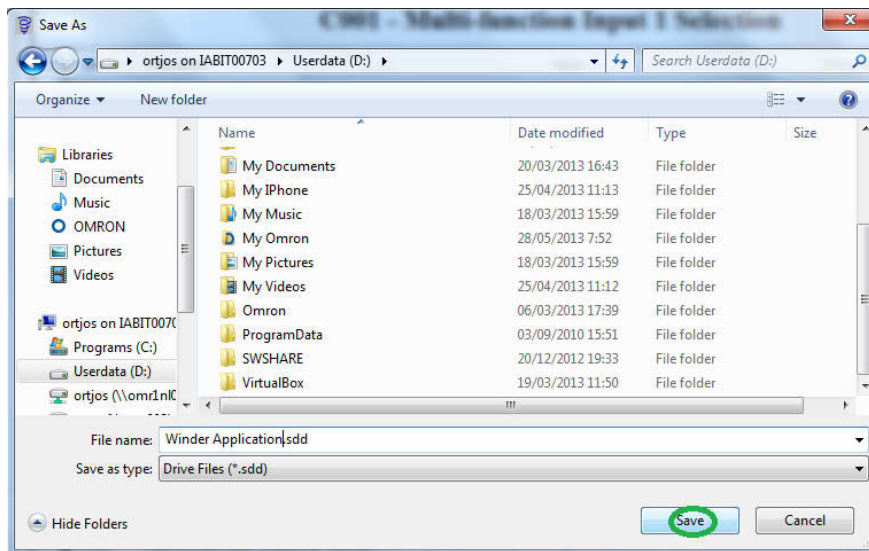

18. Start with the application configuration and inverter parameter settings.

4 DRIVE PROGRAMMING PARAMETERS

4.1 Application configuration

Follow next steps to configure the basic winder/unwinder application parameters:

1. Configure digital inputs/outputs and analog inputs/outputs. See section 4.3.
2. Set reel diameter (P100 parameter) setting in mm.
3. Set maximum line speed (P101 parameter) setting in m/min.
4. Set winder speed at minimum diameter (reel diameter) parameter setting in Hz. Please, follow next example steps to set this parameter from reel diameter, maximum line speed and gear box data:

Motor: 4 poles/50 Hz

Reel diameter: 90 mm

Max. line speed: 175 m/min

Gear box: i=2

$$L = 2 \cdot \pi \cdot r = \pi \cdot D = 3.1415 \cdot 90\text{mm} = 282.74\text{mm} / \text{rev}$$

$$\text{LineSpeed} = 175 \frac{\text{m}}{\text{min}} = 175000 \frac{\text{mm}}{\text{min}}$$

$$\text{reelSpeed}_{\text{MinDiameter}} = 175000 \frac{\text{mm}}{\text{min}} \div 282.74 \frac{\text{mm}}{\text{rev}} = 618.94\text{rpm}$$

$$\text{ShaftSpeed}_{\text{MinDiameter}} (\text{rpm}) = 618.94\text{rpm} \cdot 2 = 1237.88\text{rpm}$$

$$\text{ShaftSpeed}_{\text{MinDiameter}} (\text{Hz}) = \frac{1237.88\text{rpm}}{1500\text{rpm}} \cdot 50\text{Hz} = 41.26\text{Hz}$$

Set P113 = 4126 (41.26 Hz).

Set A004 (Shaft speed at minimum diameter · offset) = 41.26 · 1.15 (15%) = 47.44 Hz.

5. Speed offset for PID:
Set Speed offset (P111) to the desired percentage for the PID window.
6. Set maximum build up ratio. To get the maximum build up ratio, divide maximum product diameter between reel diameter and multiply the result by 1000.

Example 1:

Reel diameter: 90 mm

Product diameter: 900 mm

$$\text{MaximumBuildUpRatio} (P107) = \frac{900\text{mm}}{90\text{mm}} \cdot 1000 = 10000$$

Example 2:

Reel diameter: 90 mm

Product diameter: 700 mm

$$\text{MaximumBuildUpRatio} (P107) = \frac{700\text{mm}}{90\text{mm}} \cdot 1000 = 7777$$

7. Calibrate feedback sensor (dancer/load cell). Verify that you have 0 VDC in the analog input when you have the minimum tension feedback and 10 VDC when you have the maximum tension feedback.
8. Configure the winder application functions described in section 5.

4.2 Application software parameters

Parameter No.	Name	Setting range	Unit	Default setting	Description
P100	Reel diameter	0 to 65000	mm	42mm	Winder/unwinder reel diameter in mm
P101	Maximum line speed	0 to 600 [0 to 600m/min]	m/min	35 [35m/min]	Maximum line speed in m/min
P102	Tension set point	0 to 10000 [0.00% to 100.00%]	%	2500 [25.00%]	Tension reference
P103	Build up ratio preset value	1000 to 15000	BUR	1000	Build up ratio preset value
P104	Diameter filter time 1	0 to 200 [0.0sec to 20.0sec]	sec	20 [2.0sec]	Time used to filter diameter calculation
P105	Diameter filter time 2	0 to 200 [0.0sec to 20.0sec]	sec	60 [6.0sec]	Time used to filter diameter calculation
P106	Taper middle build up ratio	[1000 to MaxBuildUpRatio]	-	1500	This value will be used only for winder taper function
P107	Maximum build up ratio	>1000 [>MinBuildUpRatio]	BUR	6665	It's the maximum build up ratio This value is the relation between reel diameter and maximum diameter
P108	Taper tension at minimum BUR	0 to 10000 [0.0% to 100.00%]	%	10000 [100.00%]	Minimum tension for taper function at minimum diameter
P109	Taper tension at middle BUR	0 to 10000 [0.0% to 100.00%]	%	10000 [100.00%]	Medium tension for taper function at medium build up ratio
P110	Taper tension at maximum BUR	0 to 10000 [0.0% to 100.00%]	%	10000 [100.00%]	Maximum tension for taper function at maximum build up ratio
P111	Speed offset	0 to 100 [0% to 100%]	%	5 [5%]	Speed offset for final speed reference in % of maximum frequency
P112	Percentage diameter completion	0 to 10000 [0.0% to 100.00%]	%	9500 [95.00%]	When diameter reaches this percentage of max/min diameter, it will be activated one digital output to indicate that the diameter is almost complete
P113	Winder max. speed at core diameter	10000 [100.00 Hz]	Hz	4420 [44.20 Hz]	Winder maximum speed at core diameter
P116	Proportional@MinBUR	RX: 2 to 50 [0.2 to 5.0] MX2: 0 to 2500 [0.0 to 25.0]	-	RX: 2 [0.2] MX2: 100 [1.0]	Proportional value for the minimum diameter for the dynamic PID function
P117	Proportional@MaxBUR	RX: 2 to 50 [0.2 to 5.0] MX2: 0 to 2500 [0.0 to 25.0]	-	RX: 2 [0.2] MX2: 100 [1.0]	Proportional value for the maximum diameter for the dynamic PID function

4.3 Inputs/outputs

Digital inputs

Terminal input	Value	Description
1	C001 = 20: STA - 3-wire start	3-wire start
2	C002 = 21: STP - 3-wire stop	3-wire stop
3	C003 = 22: F/R - 3-wire forward/reverse	3-wire forward/reverse
4	C004 = 56: X(00) DP - Winder/unwinder mode selection	Winder/unwinder mode selection
5	C005 = 57: X(01) DP - Preset diameter	Preset diameter function
6	C006 = 58: X(02) DP - Freeze diameter	Freeze diameter function
7	C007 = 59: X(03) DP - Reset diameter	Reset diameter function
8	Not used	Not used
FW	Forward (RX)	Not used

Digital outputs

Terminal output	Value	Description
11	C021 = 44: Y(00) DP - Diameter reached	Diameter reached
12	C022 = 255: No function	Not used
13	C023 = 255: No function	Not used
14	C024 = 255: No function	Not used
15	C025 = 255: No function	Not used
AL2, AL1	C026 = 05: AL (alarm output)	Alarm output

Analog inputs

Terminal input	Value	Description
O	Tension feedback (RX/MX2)	Tension feedback (0% to 100%) [dancer/load cell]
O2	Line speed (RX)	Line speed (0% to 100%)
O1	Line speed (MX2)	Line speed (0% to 100%)

Analog outputs

Terminal output	Value	Description
AM	C028 = 13: YA(01) DP - Actual diameter	Actual diameter (voltage analog output)

4.4 Monitor parameters

Parameter No.	Name	Unit	Description
d001	Output frequency monitor	Hz	Output frequency monitor
d002	Output current monitor	A	Instantaneous current
d008	Real frequency monitor	Hz	Real frequency monitor
d025	Diameter	mm	Diameter in mm
d026	Line speed	m/min	Line speed in m/min
d027	Bias frequency	%	Bias frequency

4.5 Error codes

Error	Name	Description
E51 (RX/MX2)	Diameter preset value error	Detects if the diameter preset value is lower than minimum build up ratio
E60.x (RX)	Encoder disconnection (3G3AX-PG board)	Detects the encoder disconnection and connection failure
E70.x (RX)		
E61.x (RX)	Overspeed (3G3AX-PG board)	Detects if the motor rotation has been executed
E71.x (RX)		
E69.x (RX)	3G3AX-PG connection error	Detects PG board connection failure
E79.x (RX)		

4.6 Other relevant parameters

Parameter No.	Name	Value	Description
F002	Acceleration time 1	0.00 sec (MX2) / 0.01 sec (RX)	Acceleration time 1
F003	Deceleration time 1	0.00 sec (MX2) / 0.01 sec (RX)	Deceleration time 1
A001	Frequency reference selection	07: Drive Programming	Freq. reference selection by Drive Programming
A002	RUN command selection	01: Terminal	Run command selection
A004	Maximum frequency	-	Maximum frequency for Winder to be calculated depending on Maximum LineSpeed and Reel Diameter. See section 4.1
A016	Analog input filter	8	Analog input filter
A017	Drive Programming (EzSQ) selection	2: Always ON	Run Winder application program
A044	V/f characteristics selection	Sensor vector control 05: V2 (RX) / 03: SLV (MX2)	Control method
A071	PID selection	01: Enable	Enable PID
A076	PID feedback selection	01: Input via O	PID feedback selection
A077	PID reverse output	OFF: Winder mode ON: Unwinder mode	PID reverse output mode
A081	AVR selection	01: Always OFF	AVR selection
A097	Acceleration pattern selection	00: Line	Accel s-ramp pattern selection
A098	Deceleration pattern selection	00: Line	Decel s-ramp pattern selection
A901	Insertion point	01: Enabled	Insertion point
b013	Electronic thermal characteristics selection	01: Const TRQ (Constant torque characteristics)	Motor constant torque
b046	Reverse rotation prevention selection	00: OFF (Disabled)	Reverse rotation prevention function
b090	Usage rate of regenerative braking function	100.0 %	% duty for brake unit. Please set to 100 % for brake to work. If set to 0 %, transistor disabled
b095	Regenerative braking function operation selection	02: Alws-ON (Enabled during stop)	Regenerative braking function operation selection
b130	Overvoltage protection function selection during deceleration	00: OFF (Disabled)	Overvoltage protection function
C091	Debug mode selection	01: Enabled	Debug mode selection
H002	Motor parameter selection	01: Auto-tuning parameter	Select final motor data
P011	Encoder pulses	-	Number of actual encoder pulses

5 WINDER/UNWINDER APPLICATION FUNCTIONS

5.1 Taper function

To compensate physical effects that are difficult to model on the final product winding quality, the taper function provides a proportional compensation of the tension reference related with diameter (build up ratio). Avoid defects like telescoping and crushed rolls. Normally tension will increase as diameter increases, contrary compensation is required.

The cause for this effect is mainly:

- Attack angle of product into roll changing by diameter.
- Gravity effects on final tension due to weight of roll = f(D).

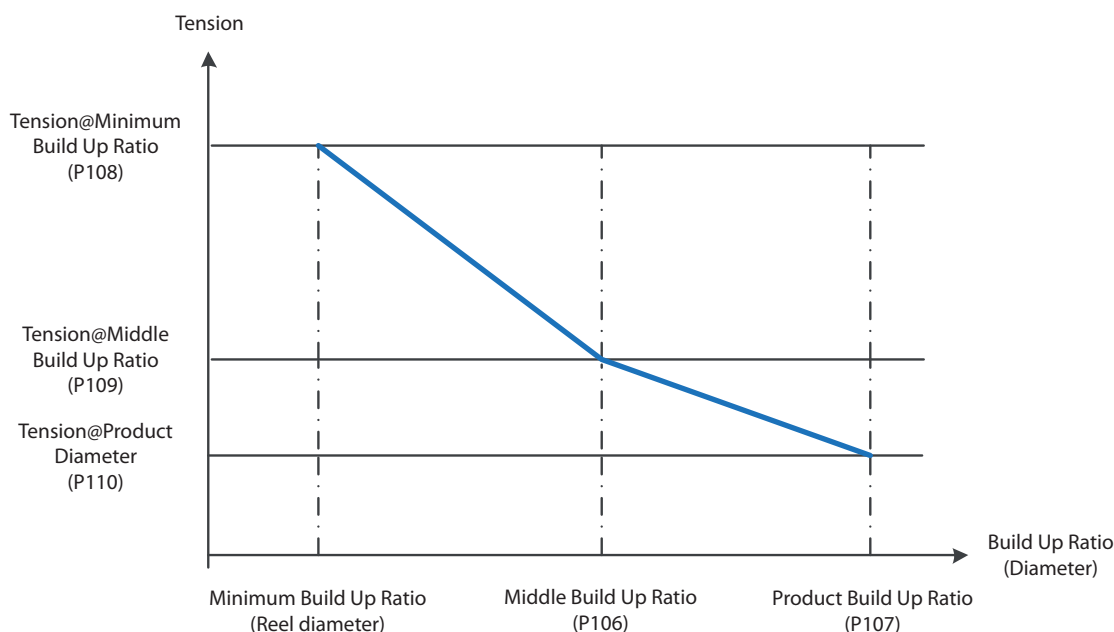

Parameter No.	Name	Setting range	Unit	Default setting	Description
P106	Tapper middle build up ratio	[1000 to MaxBuildUpRatio]	-	1500	This value will be used only for Winder taper function
P107	Maximum build up ratio	>1000 [>MinBuildUpRatio]	BUR	6665	It's the maximum build up ratio This value is the relation between reel diameter and maximum diameter
P108	Taper tension at minimum BUR	0 to 10000 [0.0% to 100.00%]	%	10000 [100.0%]	Minimum tension for taper function at minimum diameter
P109	Taper tension at middle BUR	0 to 10000 [0.0% to 100.00%]	%	10000 [100.0%]	Medium tension for taper function at medium build up ratio
P110	Taper tension at maximum BUR	0 to 10000 [0.0% to 100.00%]	%	10000 [100.0%]	Maximum tension for taper function at maximum build up ratio

Note: Minimum build up ratio value is a fixed value inside the application software (1000). It is not needed to configure it.

5.2 Preset function timing diagram

It updates current diameter calculation/estimation with the diameter introduced in the preset value parameter while the preset command is activated.

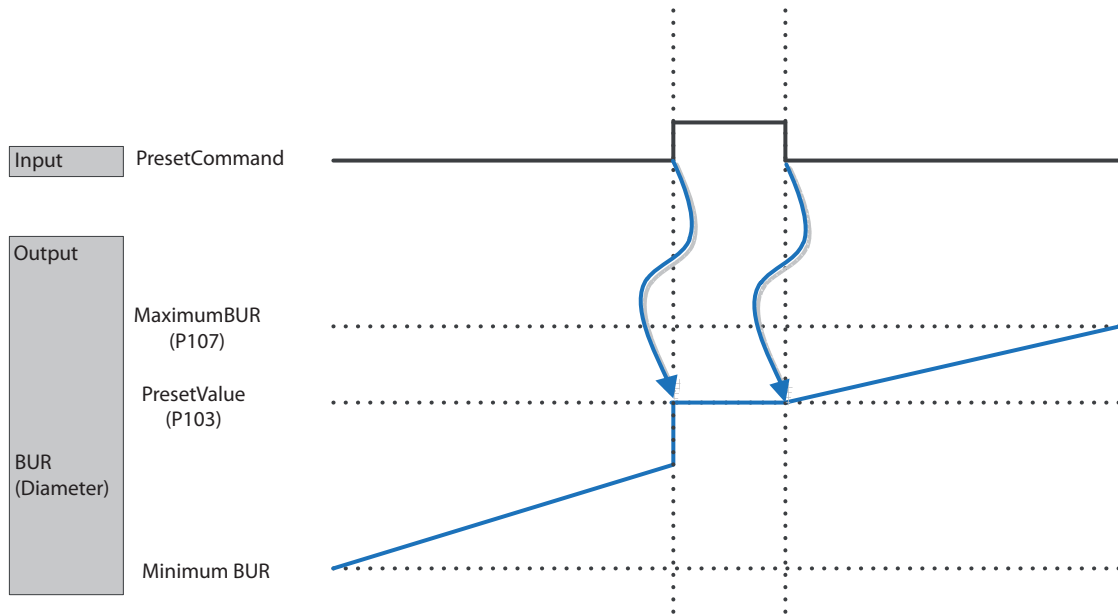

BUR = Build Up Ratio (Diameter Ratio)

Parameter No.	Name	Setting range	Unit	Default setting	Description
P103	Diameter@BUR preset value	100 to 15000	BUR	1000	Diameter@BuildUpRatio for preset value

Note: Diameter preset value must be introduced in build up ratio units.

Example:

Reel diameter: 90 mm
 Preset diameter: 450 mm
 Product diameter (max. diameter): 900 mm

$$PresetBuildUpRatio (P103) = \frac{450mm}{90mm} \cdot 1000 = 5000$$

5.3 Freeze function timing diagram

It freezes current diameter calculation/estimation while the Freeze Command input is activated.

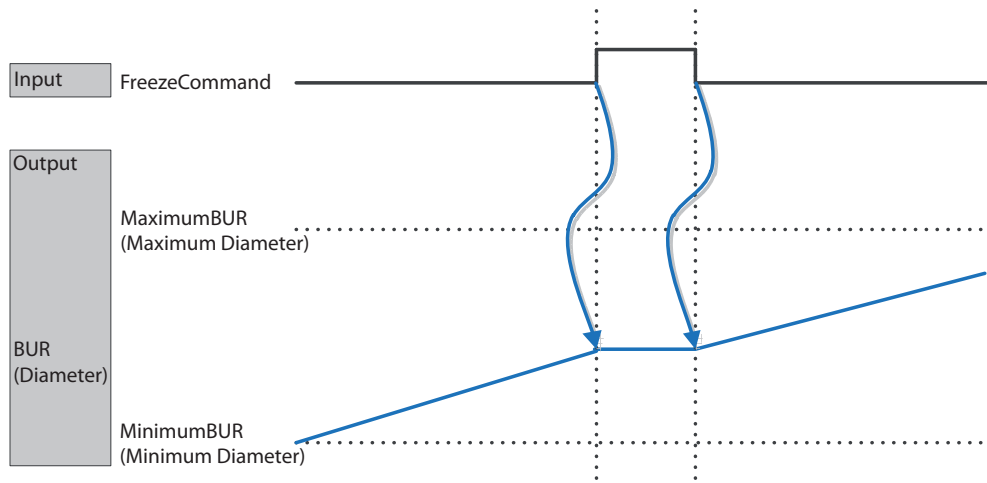

5.4 Reset function timing diagram

It resets current diameter. In winder mode. See below timing diagrams:

Winder

It will reset current diameter to the minimum build up ratio (reel diameter).

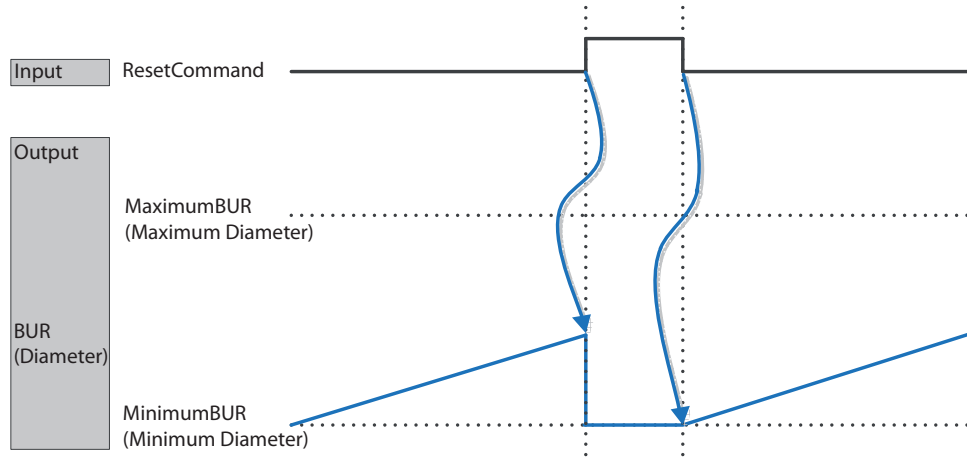

Unwinder

In unwinder mode, it will reset current diameter to the maximum build up ratio (product diameter).

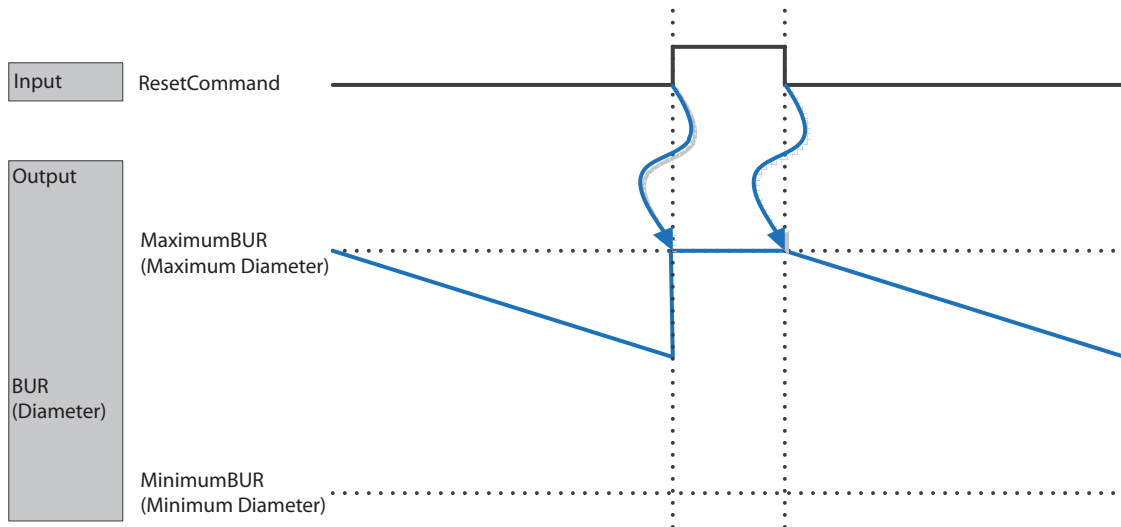

5.5 Diameter completion function

It indicates when the job in winder or unwinder mode is complete.

Winder

In winder mode, the diameter reached output signal will be activated when current diameter reaches the percentage indicated in Percentage Diameter Completion parameter (P112) of the maximum diameter.

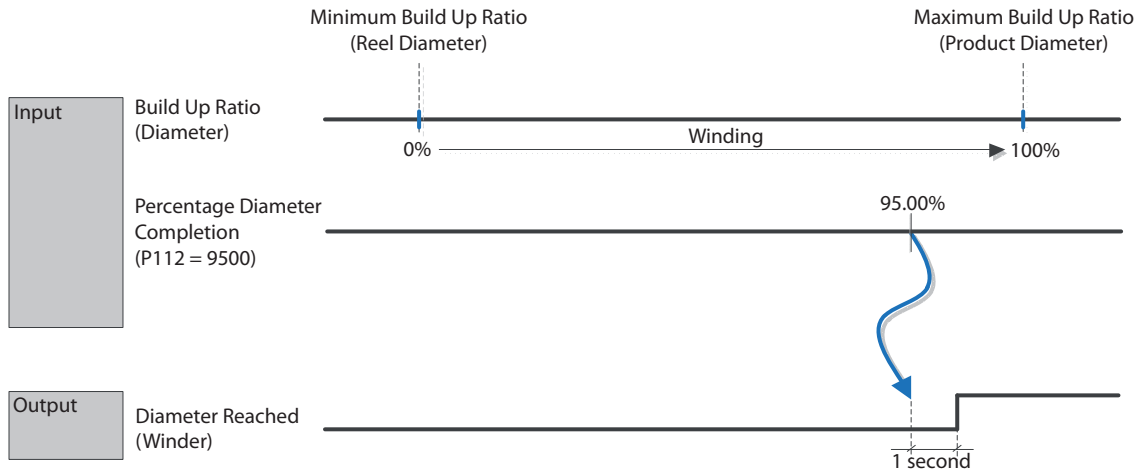

Where:

- Minimum build up ratio: 1000
- Minimum build up ratio: (Maximum product diameter (mm) / Reel diameter (mm)) * 1000

Unwinder

In unwinding mode, the diameter reached output signal will be activated when current diameter reaches the percentage indicated in Percentage Diameter Completion parameter (P112) of the reel diameter.

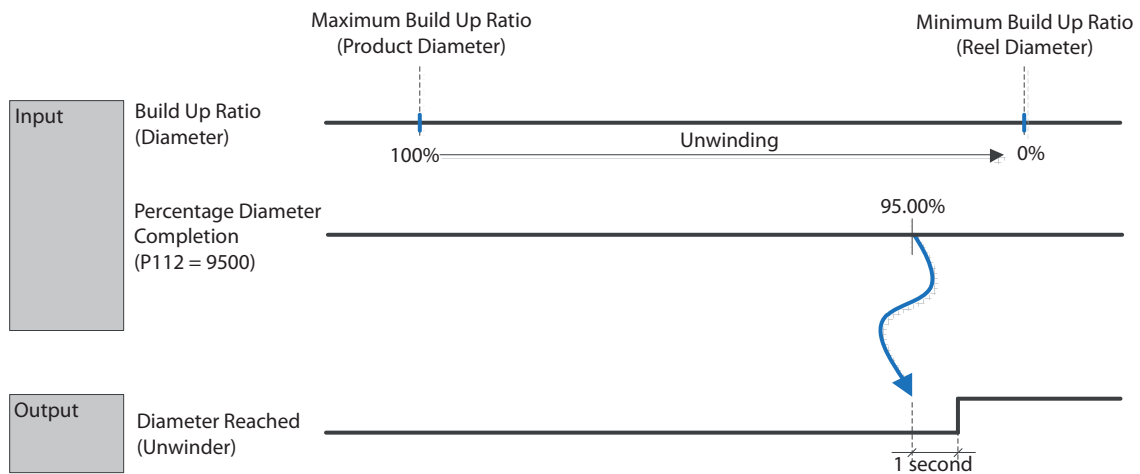

Parameter No.	Name	Setting range	Unit	Default setting	Description
P112	Percentage diameter completion	0 to 10000 [0.00% to 100.00%]	%	9500 [95.00%]	When diameter reaches this percentage of max/min diameter, it will be activated one digital output to indicate that the diameter is almost complete

5.6 Dynamic PID function

It changes the PID proportional value depending on current calculated diameter ratio.

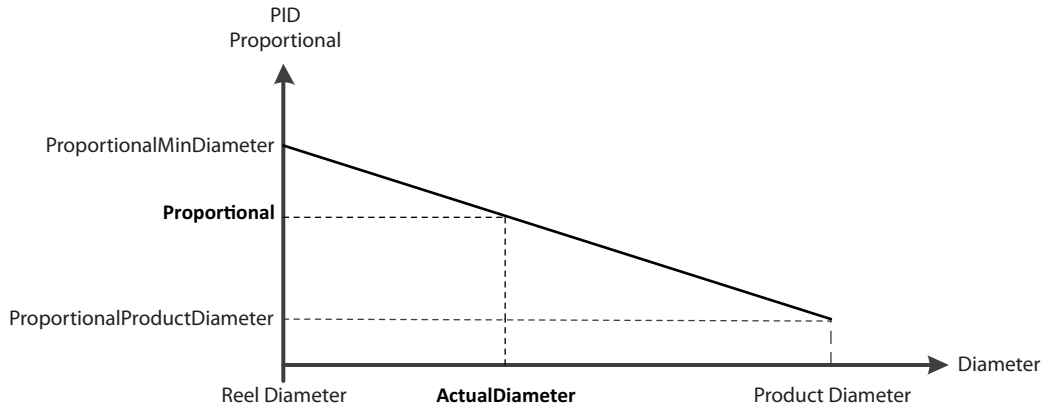

Parameter No.	Name	Setting range	Unit	Default setting	Description
P116	Proportional@MinBUR	RX: 2 to 50 [0.2 to 5.0] MX2: 0 to 2500 [0.0 to 25.0]	-	RX: 2 [0.2] MX2: 100 [1.0]	Proportional value for the minimum diameter for the dynamic PID function
P117	Proportional@MaxBUR	RX: 2 to 50 [0.2 to 5.0] MX2: 0 to 2500 [0.0 to 25.0]	-	RX: 2 [0.2] MX2: 100 [1.0]	Proportional value for the maximum diameter for the dynamic PID function

OMRON

Authorized Distributor: