

Digital Temperature Controllers Programmable Type

Communications Manual

E5□C-T



1
Communications
Methods

2
CompoWay/F Commu-
nications Procedures

3
Communications
Data for CompoWay/F

4
Modbus Communica-
tions Procedure

5
Communications
Data for Modbus

6
Programless
Communications

7
Component
Communications

A
Appendices

I
Index

Preface

This Communications Manual describes the communications capabilities supported by the E5□C-T Digital Controllers.

Read and understand this manual before using communications with the E5□C-T Digital Controllers and be sure you are performing communications correctly.

Keep this manual in a safe location where it will be available when needed.

© OMRON, 2014

All rights reserved. No part of this publication may be reproduced, stored in a retrieval system or transmitted, in any form, or by any means, mechanical, electronic, photocopying, recording, or otherwise, without the prior written permission of OMRON.

No patent liability is assumed with respect to the use of the information contained herein. Moreover, because OMRON is constantly striving to improve its high-quality products, the information contained in this manual is subject to change without notice. Every precaution has been taken in the preparation of this manual. Nevertheless, OMRON assumes no responsibility for errors or omissions. Neither is any liability assumed for damages resulting from the use of the information contained in this publication.

Terms and Conditions Agreement

Warranty, Limitations of Liability

Warranties

- **Exclusive Warranty**

Omron's exclusive warranty is that the Products will be free from defects in materials and workmanship for a period of twelve months from the date of sale by Omron (or such other period expressed in writing by Omron). Omron disclaims all other warranties, express or implied.

- **Limitations**

OMRON MAKES NO WARRANTY OR REPRESENTATION, EXPRESS OR IMPLIED, ABOUT NON-INFRINGEMENT, MERCHANTABILITY OR FITNESS FOR A PARTICULAR PURPOSE OF THE PRODUCTS. BUYER ACKNOWLEDGES THAT IT ALONE HAS DETERMINED THAT THE PRODUCTS WILL SUITABLY MEET THE REQUIREMENTS OF THEIR INTENDED USE.

Omron further disclaims all warranties and responsibility of any type for claims or expenses based on infringement by the Products or otherwise of any intellectual property right.

- **Buyer Remedy**

Omron's sole obligation hereunder shall be, at Omron's election, to (i) replace (in the form originally shipped with Buyer responsible for labor charges for removal or replacement thereof) the non-complying Product, (ii) repair the non-complying Product, or (iii) repay or credit Buyer an amount equal to the purchase price of the non-complying Product; provided that in no event shall Omron be responsible for warranty, repair, indemnity or any other claims or expenses regarding the Products unless Omron's analysis confirms that the Products were properly handled, stored, installed and maintained and not subject to contamination, abuse, misuse or inappropriate modification. Return of any Products by Buyer must be approved in writing by Omron before shipment. Omron Companies shall not be liable for the suitability or unsuitability or the results from the use of Products in combination with any electrical or electronic components, circuits, system assemblies or any other materials or substances or environments. Any advice, recommendations or information given orally or in writing, are not to be construed as an amendment or addition to the above warranty.

See <http://www.omron.com/global/> or contact your Omron representative for published information.

Limitation on Liability; Etc

OMRON COMPANIES SHALL NOT BE LIABLE FOR SPECIAL, INDIRECT, INCIDENTAL, OR CONSEQUENTIAL DAMAGES, LOSS OF PROFITS OR PRODUCTION OR COMMERCIAL LOSS IN ANY WAY CONNECTED WITH THE PRODUCTS, WHETHER SUCH CLAIM IS BASED IN CONTRACT, WARRANTY, NEGLIGENCE OR STRICT LIABILITY.

Further, in no event shall liability of Omron Companies exceed the individual price of the Product on which liability is asserted.

Application Considerations

Suitability of Use

Omron Companies shall not be responsible for conformity with any standards, codes or regulations which apply to the combination of the Product in the Buyer's application or use of the Product. At Buyer's request, Omron will provide applicable third party certification documents identifying ratings and limitations of use which apply to the Product. This information by itself is not sufficient for a complete determination of the suitability of the Product in combination with the end product, machine, system, or other application or use. Buyer shall be solely responsible for determining appropriateness of the particular Product with respect to Buyer's application, product or system. Buyer shall take application responsibility in all cases.

NEVER USE THE PRODUCT FOR AN APPLICATION INVOLVING SERIOUS RISK TO LIFE OR PROPERTY WITHOUT ENSURING THAT THE SYSTEM AS A WHOLE HAS BEEN DESIGNED TO ADDRESS THE RISKS, AND THAT THE OMRON PRODUCT(S) IS PROPERLY RATED AND INSTALLED FOR THE INTENDED USE WITHIN THE OVERALL EQUIPMENT OR SYSTEM.

Programmable Products

Omron Companies shall not be responsible for the user's programming of a programmable Product, or any consequence thereof.

Disclaimers

Performance Data

Data presented in Omron Company websites, catalogs and other materials is provided as a guide for the user in determining suitability and does not constitute a warranty. It may represent the result of Omron's test conditions, and the user must correlate it to actual application requirements. Actual performance is subject to the Omron's Warranty and Limitations of Liability.

Change in Specifications

Product specifications and accessories may be changed at any time based on improvements and other reasons. It is our practice to change part numbers when published ratings or features are changed, or when significant construction changes are made. However, some specifications of the Product may be changed without any notice. When in doubt, special part numbers may be assigned to fix or establish key specifications for your application. Please consult with your Omron's representative at any time to confirm actual specifications of purchased Product.

Errors and Omissions

Information presented by Omron Companies has been checked and is believed to be accurate; however, no responsibility is assumed for clerical, typographical or proofreading errors or omissions.

Safety Precautions

Definition of Precautionary Information





The following notation is used in this manual to provide precautions required to ensure safe usage of the E5□C-T Digital Controllers.

The safety precautions that are provided are extremely important to safety. Always read and heed the information provided in all safety precautions.

The following notation is used.

 CAUTION	Indicates a potentially hazardous situation which, if not avoided, may result in minor or moderate injury or in property damage.
Precautions for Safe Use	Supplementary comments on what to do or avoid doing, to use the product safely.
Precautions for Correct Use	Supplementary comments on what to do or avoid doing, to prevent failure to operate, malfunction or undesirable effect on product performance.

Symbols

Symbol		Meaning
Caution		<ul style="list-style-type: none"> General Caution Indicates non-specific general cautions, warnings, and dangers.
		<ul style="list-style-type: none"> Electrical Shock Caution Indicates possibility of electric shock under specific conditions.
Prohibition		<ul style="list-style-type: none"> General Prohibition Indicates non-specific general prohibitions.
		<ul style="list-style-type: none"> Disassembly Prohibition Indicates prohibitions when there is a possibility of injury, such as from electric shock, as the result of disassembly.
Mandatory Caution		<ul style="list-style-type: none"> General Caution Indicates non-specific general cautions, warnings, and dangers.

● Safety Precautions

CAUTION

Minor injury due to electric shock may occasionally occur.
Do not touch the terminals while power is being supplied.



Electric shock, fire, or malfunction may occasionally occur.
Do not allow metal objects, conductors, cuttings from installation work, or moisture to enter the Digital Controller or a Setup Tool port. Attach the cover to the front-panel Setup Tool port whenever you are not using it to prevent foreign objects from entering the port.



Minor injury from explosion may occasionally occur.
Do not use the product where subject to flammable or explosive gas.



Fire may occasionally occur.
Do not allow dirt or other foreign objects to enter a Setup Tool port, or between the pins on the connectors on the Setup Tool cable.



Minor electric shock, fire, or malfunction may occasionally occur.
Never disassemble, modify, or repair the product or touch any of the internal parts.



CAUTION - Risk of Fire and Electric Shock

- (a) This product is UL listed as Open Type Process Control Equipment. It must be mounted in an enclosure that does not allow fire to escape externally.
- (b) More than one disconnect switch may be required to de-energize the equipment before servicing.
- (c) Signal inputs are SELV, limited energy.*¹
- (d) Caution: To reduce the risk of fire or electric shock, do not interconnect the outputs of different Class 2 circuits.*²



If the output relays are used past their life expectancy, contact fusing or burning may occasionally occur.
Always consider the application conditions and use the output relays within their rated load and electrical life expectancy. The life expectancy of output relays varies considerably with the output load and switching conditions.



*1 An SELV (separated extra-low voltage) system is one with a power supply that has double or reinforced insulation between the primary and the secondary circuits and has an output voltage of 30 V r.m.s. max. and 42.4 V peak max. or 60 VDC max.

*2 A class 2 circuit is one tested and certified by UL as having the current and voltage of the secondary output restricted to specific levels.

CAUTION

Loose screws may occasionally result in fire.
Tighten the terminal screws to the specified torque of 0.43 to 0.58 N·m.



Set the parameters of the product so that they are suitable for the system being controlled. If they are not suitable, unexpected operation may occasionally result in property damage or accidents.



A malfunction in the Digital Controller may occasionally make control operations impossible or prevent alarm outputs, resulting in property damage. To maintain safety in the event of malfunction of the Digital Controller, take appropriate safety measures, such as installing a monitoring device on a separate line.



Precautions for Safe Use

Be sure to observe the following precautions to prevent operation failure, malfunction, or adverse affects on the performance and functions of the product. Not doing so may occasionally result in unexpected events. Use the product within specifications.

- The product is designed for indoor use only. Do not use or store the product in any of the following places.
 - Places directly subject to heat radiated from heating equipment.
 - Places subject to splashing liquid or oil atmosphere.
 - Places subject to direct sunlight.
 - Places subject to dust or corrosive gas (in particular, sulfide gas and ammonia gas).
 - Places subject to intense temperature change.
 - Places subject to icing and condensation.
 - Places subject to vibration and large shocks.
- Use and store the Digital Controller within the rated ambient temperature and humidity. Gang-mounting two or more Digital Controllers, or mounting Digital Controllers above each other may cause heat to build up inside the Digital Controllers, which will shorten their service life. In such a case, use forced cooling by fans or other means of air ventilation to cool down the Digital Controllers.
- To allow heat to escape, do not block the area around the product. Do not block the ventilation holes on the product.
- Be sure to wire properly with correct polarity of terminals.
- Use the specified size of crimped terminals (M3, width of 5.8 mm or less) for wiring. To connect bare wires to the terminal block, use copper braided or solid wires with a gage of AWG24 to AWG18 (equal to a cross-sectional area of 0.205 to 0.8231 mm²). (The stripping length is 6 to 8 mm.) Up to two wires of the same size and type, or two crimped terminals can be inserted into a single terminal.
- Do not wire the terminals that are not used.
- To avoid inductive noise, keep the wiring for the Digital Controller's terminal block away from power cables that carry high voltages or large currents. Also, do not wire power lines together with or parallel to Digital Controller wiring. Using shielded cables and using separate conduits or ducts are recommended.

Attach a surge suppressor or noise filter to peripheral devices that generate noise (in particular, motors, transformers, solenoids, magnetic coils or other equipment that have an inductance component).

When a noise filter is used at the power supply, first check the voltage or current, and attach the noise filter as close as possible to the Digital Controller.

Allow as much space as possible between the Digital Controller and devices that generate powerful high frequencies (high-frequency welders, high-frequency sewing machines, etc.) or surge.
- Use the product within the rated load and power supply.
- Make sure that the rated voltage is attained within 2 seconds of turning ON the power using a switch or relay contact. If the voltage is applied gradually, the power may not be reset or output malfunctions may occur.
- Make sure that the Digital Controller has 30 minutes or more to warm up after turning ON the power before starting actual control operations to ensure the correct temperature display.
- A switch or circuit breaker must be provided close to the Digital Controller. The switch or circuit breaker must be within easy reach of the operator, and must be marked as a disconnecting means for the Digital Controller.
- Wipe off any dirt from the Digital Controller with a soft dry cloth. Never use thinners, benzene, alcohol, or any cleaners that contain these or other organic solvents. Deformation or discoloration may occur.

- Design the system (e.g., control panel) considering the 2 seconds of delay in setting the Digital Controller's output after the power supply is turned ON.
- The output will turn OFF when you move to the initial setting level. Take this into consideration when performing control.
- The number of non-volatile memory write operations is limited. Therefore, use RAM write mode when frequently overwriting data, e.g., through communications.
- Use suitable tools when taking the Digital Controller apart for disposal. Sharp parts inside the Digital Controller may cause injury.
- Do not connect cables to both the front-panel Setup Tool port and the top-panel Setup Tool port at the same time. Damage or malfunction may occur.
- Do not exceed the communications distance that is given in the specifications and use the specified communications cable. Refer to the *E5□C-T Digital Temperature Controllers User's Manual* (Cat. No. H185) for the communications distance and cable specifications.
- Do not turn the power supply to the Digital Controller ON or OFF while the USB-Serial Conversion Cable is connected. The Digital Controller may malfunction.
- Do not bend the communications cables past their natural bending radius. Do not pull on the communications cables.

Trademarks

- MELSEC and GX-Works are trademarks of the Mitsubishi Electric Corporation. Other company names and product names in this document are the trademarks or registered trademarks of their respective companies.

Versions

Check the version on the nameplate on the E5□C-T Controller or on the label on the packing box. If the version is not given, the version of the E5□C-T Controller is version 1.0.

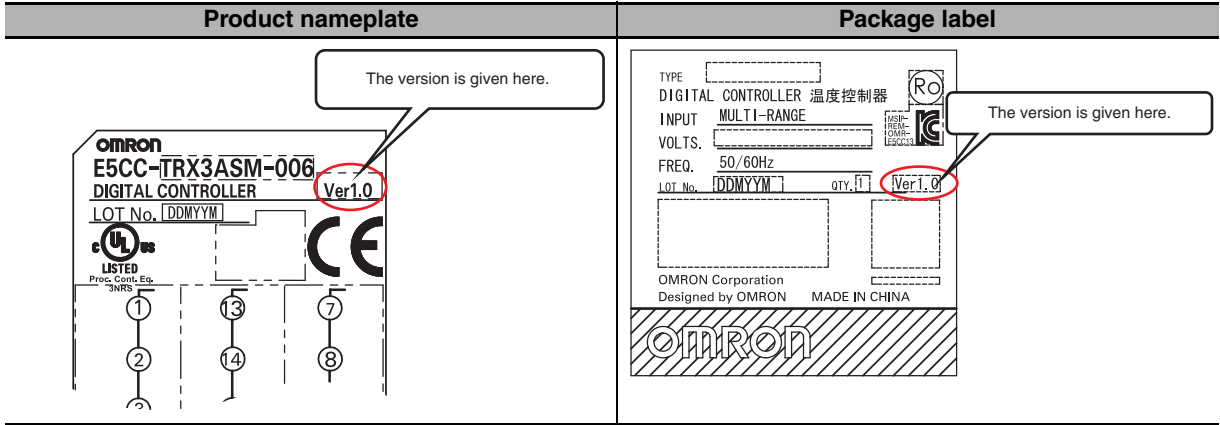

Revision History

A manual revision code appears as a suffix to the catalog number on the front cover of the manual.

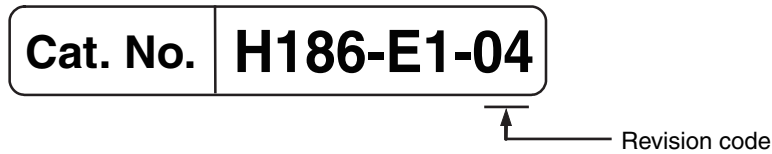

Revision code	Date	Revised content
01	January 2014	Original production
02	May 2014	Page 5-7: Corrected mistakes in Modbus parameters.
03	June 2015	Page 3-11: Added note *2 and references to it in table. Pages 5-19 and 5-20: Changed <i>Parameter name</i> column and added note. Page 6-5: Added note *2 and changed references to notes in table. Added "RS-485" for port 2 of CP-series CPU Units. Page 6-8: Changed numbers from +15 to +18 in table. Pages 6-31, 6-32, 6-48, and 6-49: Changed screen capture at bottom of page. Page 7-2: Added note 3.
04	January 2017	Corrected mistakes and added explanations.

Sections in This Manual

How This Manual is Organized

Descriptions in this manual are separated by the communications method.
Read the sections that are applicable to the system being used.

		1
1	Communications Methods	2
2	CompoWay/F Communications Procedures	3
3	Communications Data for CompoWay/F	4
4	Modbus Communications Procedure	5
5	Communications Data for Modbus	6
6	Programless Communications	7
7	Component Communications	A
A	Appendices	I
I	Index	

Related Manuals

For details on the functions of the E5□C-T Digital Controllers, refer to the *E5□C-T Digital Temperature Controllers User's Manual* (Cat. No. H185).

CONTENTS

Preface	1
Terms and Conditions Agreement.....	2
Warranty, Limitations of Liability	2
Application Considerations	3
Disclaimers	3
Safety Precautions	4
Definition of Precautionary Information	4
Symbols	4
Precautions for Safe Use	7
Trademarks	9
Versions	10
Revision History	11
Sections in This Manual	13
How This Manual is Organized	13
Related Manuals	13

Section 1 **Communications Methods**

1-1 Overview of Communications Methods	1-2
1-1-1 Introduction	1-2
1-1-2 Communications Specifications	1-2
1-1-3 Transmission Procedure.....	1-3
1-1-4 Interface	1-3
1-1-5 Wiring.....	1-3
1-1-6 Communications Parameters	1-4
1-1-7 Communications Parameter Setup	1-4
1-1-8 Description of Communications Parameters	1-5

Section 2 **CompoWay/F Communications Procedures**

2-1 Data Format.....	2-2
2-1-1 Command Frame	2-2
2-1-2 BCC Calculation Example.....	2-3
2-1-3 Response Frame.....	2-3
2-1-4 Communications Data.....	2-4
2-1-5 End Code Example	2-4
2-2 Structure of Command Text.....	2-6
2-2-1 PDU Structure	2-6
2-2-2 Area Definitions.....	2-6
2-2-3 Type Code (Variable Type)	2-6
2-2-4 Addresses	2-7
2-2-5 Number of Elements	2-7
2-2-6 List of Services (Main Request Codes and Sub-Request Codes)	2-7
2-3 Detailed Description of the Services	2-8
2-3-1 Read Variable Area	2-8
2-3-2 Write Variable Area	2-9
2-3-3 Composite Read from Variable Area.....	2-10

2-3-4	Composite Write to Variable Area.....	2-12
2-3-5	Read Controller Attributes	2-13
2-3-6	Read Controller Status	2-14
2-3-7	Echoback Test	2-15
2-3-8	Operation Command	2-17
2-4	Response Code List	2-22

Section 3 Communications Data for CompoWay/F

3-1	Variable Area (Setting Range) List.....	3-2
3-2	Status and Status 2	3-31

Section 4 Modbus Communications Procedure

4-1	Data Format.....	4-2
4-1-1	Command Frame	4-2
4-1-2	Response Frame	4-4
4-1-3	Error Codes	4-5
4-2	Function List.....	4-6
4-3	Variable Area.....	4-7
4-4	Detailed Description of the Services	4-8
4-4-1	Variable Read, Multiple	4-8
4-4-2	Variable Write, Multiple	4-10
4-4-3	Variable Write, Single/Operation Command	4-12
4-4-4	Echoback Test	4-14

Section 5 Communications Data for Modbus

5-1	Variable Area (Setting Range) List.....	5-2
5-2	Status.....	5-21

Section 6 Programless Communications

6-1	Programless Communications.....	6-3
6-1-1	Introduction.....	6-3
6-1-2	Features.....	6-3
6-1-3	Operation for Programless Communications	6-4
6-1-4	Timing of Turning Power ON and OFF.....	6-4
6-1-5	Connectable PLCs.....	6-5
6-2	E5□C-T Controller Setup	6-6
6-2-1	Protocol Setting	6-6
6-2-2	Communications Unit No. and Communications Baud Rate	6-7
6-2-3	Send Data Wait Time.....	6-7
6-2-4	Highest Communications Unit No.	6-7
6-2-5	Areas and First Address of Linked Data	6-8
6-2-6	Receive Data Wait Time	6-10
6-2-7	Communications Node Number.....	6-10
6-2-8	Upload Settings and Download Settings	6-11
6-2-9	Copying Parameter Settings	6-15
6-2-10	Communications Writing.....	6-18
6-2-11	Communications Monitor Parameter	6-19

6-3	Controlling Programless Communications.....	6-20
6-3-1	Controlling Programless Communications with the Request Flag	6-20
6-3-2	Response Flag.....	6-21
6-3-3	Range of Operation for Programless Communications.....	6-22
6-3-4	Operation Command Codes	6-22
6-3-5	Confirming Operation of Programless Communications	6-22
6-3-6	Write Mode.....	6-22
6-3-7	Troubleshooting.....	6-23
6-4	Connecting to CP-series PLCs.....	6-24
6-4-1	Configuration and Procedure	6-24
6-4-2	Switch Settings and Wiring	6-25
6-4-3	PLC Setup.....	6-25
6-4-4	E5□C-T Controller Setup.....	6-28
6-4-5	Checking Operation	6-30
6-5	Connecting to CJ-series PLCs	6-35
6-5-1	Configuration and Procedure	6-35
6-5-2	Switch Settings and Wiring	6-36
6-5-3	PLC Setup.....	6-36
6-5-4	E5□C-T Controller Setup.....	6-39
6-5-5	Checking Operation	6-39
6-6	Connecting to MELSEC Q-series PLCs	6-40
6-6-1	Configuration and Procedure	6-40
6-6-2	Wiring.....	6-41
6-6-3	PLC Setup.....	6-41
6-6-4	E5□C-T Controller Setup.....	6-46
6-6-5	Checking Operation	6-47

Section 7 Component Communications

7-1	Component Communications.....	7-2
7-1-1	Introduction	7-2
7-1-2	Wiring.....	7-3
7-1-3	E5□C-T Controller Setup.....	7-4
7-2	Operation for Component Communications.....	7-6
7-3	Troubleshooting.....	7-7

Section A Appendices

A-1	ASCII List.....	A-2
A-2	Troubleshooting.....	A-3

Index



1

Communications Methods

This section briefly describes the supported communications methods and how to wire equipment. Refer to this section when setting up equipment.

1-1	Overview of Communications Methods	1-2
1-1-1	Introduction	1-2
1-1-2	Communications Specifications	1-2
1-1-3	Transmission Procedure	1-3
1-1-4	Interface	1-3
1-1-5	Wiring	1-3
1-1-6	Communications Parameters	1-4
1-1-7	Communications Parameter Setup	1-4
1-1-8	Description of Communications Parameters	1-5

1-1 Overview of Communications Methods

1-1-1 Introduction

The program for the communications functions is created on the host (personal computer, PLC, or other type of communications master), and the E5□C-T's parameters are monitored or set from the host. Therefore, the description provided here is from the viewpoint of the host.

CompoWay/F is OMRON's standard communications format for general serial communications. This format uses a standard frame format as well as the well-established FINS* commands used for OMRON's PLCs. Therefore, it can simplify communications between components and the host.

* FINS (Factory Interface Network service)

The FINS protocol provides message communications between controllers in OMRON FA networks.

Modbus is a standard communications control method that conforms to the Modicon Company's RTU-mode Modbus Protocol (PI-MBUS-300 Revision J). Modbus is a registered trademark of Schneider Electric.

It supports functions equivalent to the CompoWay/F Read Variable Area, Write Variable Area, Operation Command, and Echoback Test functions.

The E5□C-T supports the following communications functions.

- Reading/writing of parameters
- Operation instructions
- Selection of setup levels

Communications are subject to the following condition:

- Parameters can be written only when the Communications Writing parameter is set to ON (enabled).

1-1-2 Communications Specifications

Transmission line connection	RS-485: Multidrop
Communications method	RS-485 (2-wire, half-duplex)
Synchronization method	Start-stop synchronization
Communications baud rate *	9,600, 19,200, 38,400 or 57,600 bps
Communications code	ASCII
Communications data length *	7 or 8 bits
Communications stop bits *	1 or 2 bits
Error detection	Vertical parity (none, even, or odd) * BCC (Block Check Character) with CompoWay/F communications CRC-16 (Cyclic Redundancy Check 16) with Modbus communications
Flow control	None
Interface	RS-485
Retry function	None
Communications buffer	217 bytes
Send data wait time	0 to 99 ms, default time: 20 ms

* Communications baud rate, data length, stop bits and vertical parity can each be set independently in the communications setting level. Highlighted values indicate default settings.

1-1-3 Transmission Procedure

When the host transmits a command frame, the E5□C-T transmits a response frame that corresponds to the command frame. A single response frame is returned for each command frame. The following diagram shows the operation of the command and response frames.

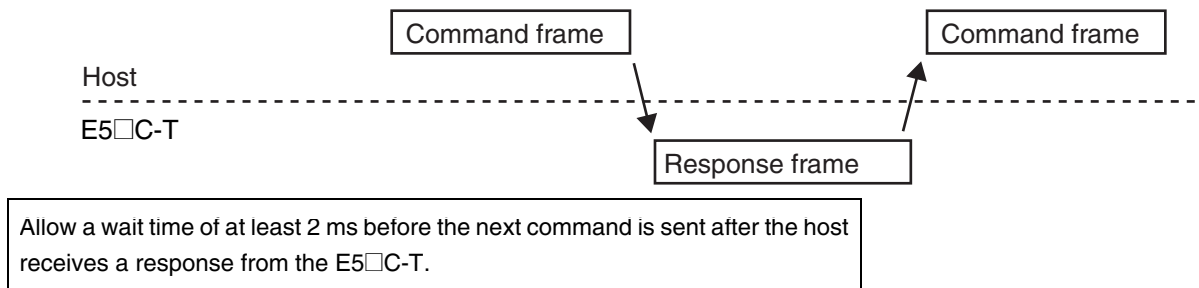

1-1-4 Interface

Communications with the host are carried out through a standard RS-485 interface. Use a K3SC Interface Converter for RS-485 interface conversion.

1-1-5 Wiring

● RS-485

- The RS-485 connection can be either one-to-one or one-to-N. Up to 32 units including the host can be connected in a one-to-N system.
- The total cable length is 500 m max.
- Use a shielded twisted-pair cable with a wire gauge of AWG24 to AWG18 (cross-sectional area of 0.205 to 0.823 mm²).

E5CC-T/EC-T/AC-T

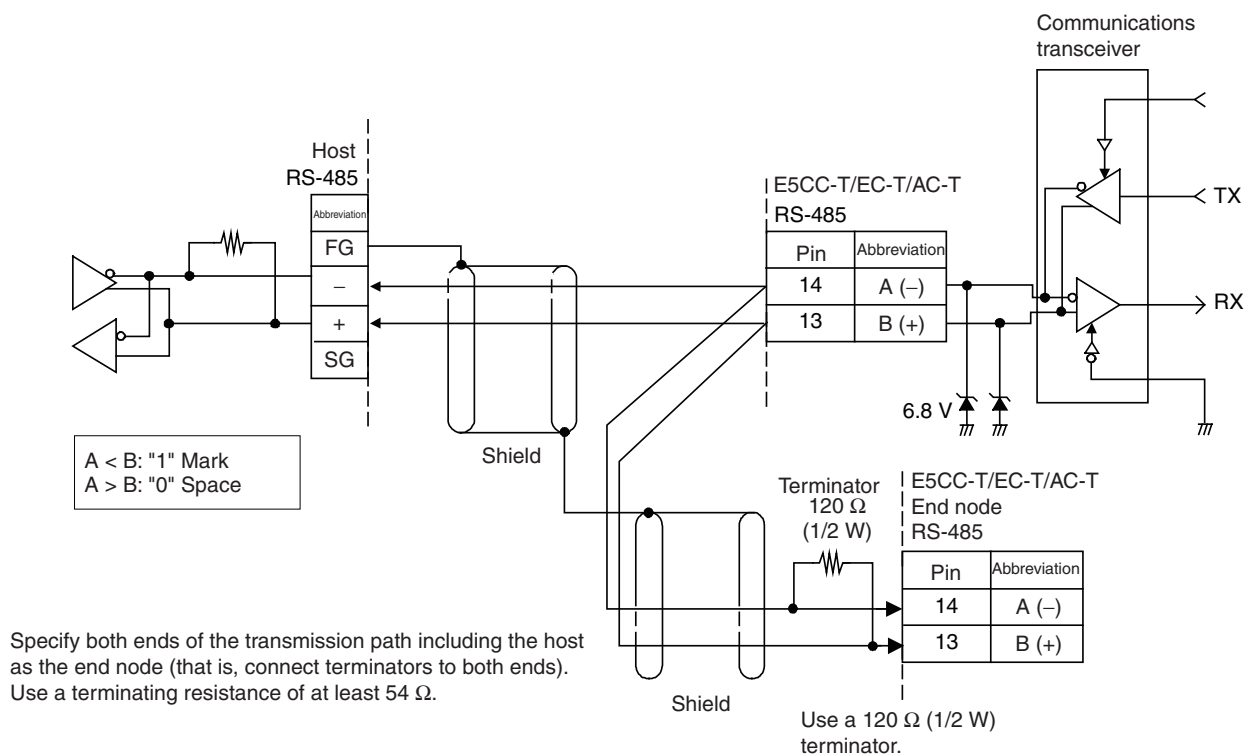

1-1-6 Communications Parameters

The E5□C-T's communications specifications are set in the communications setting level. These parameters are set on the E5□C-T's front panel. The following table shows the communications parameters and their setting ranges.





Item	Code	Settings	Set Values
Communications protocol setting	PSEL	CompoWay/F /Modbus	LWF/M \bar{o} d
Communications unit No.	U-N \bar{o}	0 to 99	0, 1 to 99
Communications baud rate	bPS	9.6/19.2/38.4/57.6 (kbit/s)	9.6/19.2 /38.4/57.6 (kbit/s)
Communications data length *	LEN	7/8 (bit)	7/8 (bit)
Communications stop bits *	Sb \bar{c} t	1/2	1/2
Communications parity	PR \bar{E} Y	None, Even, Odd	N \bar{o} NE/EVEN/O \bar{d} d
Send data wait time	Sd \bar{W} t	0 to 99	0 to 99 ms, default time: 20 ms

Highlighted values indicate default settings.

* When the Protocol Setting parameter is set to Modbus, the communications data length must be 8 bits, and the communications stop bits must be 1 bit by setting the communications parity to Even/Odd or it must be 2 bits by setting the parity to None. These two parameters are not displayed on the Controller's display.

1-1-7 Communications Parameter Setup

Before you carry out communications with the E5□C-T, set up the communications unit number, baud rate, and other parameters by carrying out the following procedure. For details on operations other than communications parameter setup, refer to the *E5□C-T Digital Temperature Controllers User's Manual* (Cat. No. H185).

- (1) Press the  Key for at least three seconds to move from the "operation level" to the "initial setting level."
- (2) Press the  Key for less than one second to move from the "initial setting level" to the "communications setting level."
- (3) Select the parameters as shown below by pressing the  Key.
- (4) Press the  or  Key to change the parameter set values.

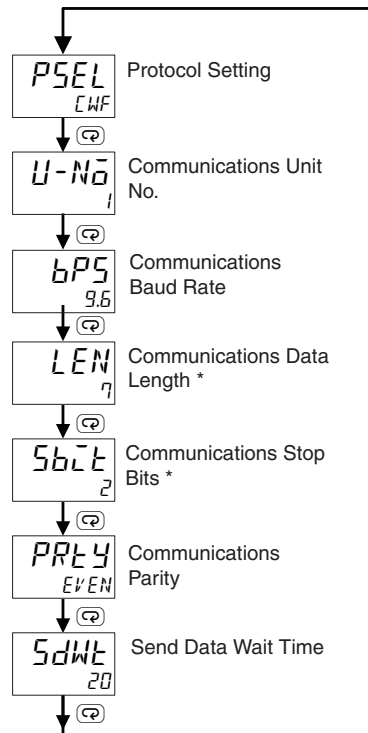

* Displayed only when the Protocol Setting parameter is set to CompoWay/F.

1-1-8 Description of Communications Parameters

When communications parameter settings have been changed, the new settings must be enabled by resetting the Controller.

- Protocol Setting (*PSEL*)
The communications protocol can be selected. Set CompoWay/F or Modbus.
- Communications Unit No. (*U-N \bar{a}*)
This parameter is for setting a unique unit number for each of the Digital Controllers. This unit number is set so that the host can identify the Digital Controller when communications are carried out with the host. The unit number can be set to an integer value between 0 and 99. The default is "1." When two or more Digital Controllers are used, do not set the same unit number. Doing so will prevent normal operation.
- Communications Baud Rate (*bPS*)
This parameter is for setting the baud rate for communications with the host. The communications baud rate settings are as follows: 9.6 (9600 bps), 19.2 (19200 bps), 38.4 (38400 bps) or 57.6 (57600 bps)
- Communications Data Length (*LEN*)
This parameter is for setting the number of communications data bits. Set either "7 bits" or "8 bits."
- Communications Stop Bits (*SB \bar{L}*)
This parameter is for setting the number of communications stop bits. Set either "1" or "2."
- Communications Parity (*PR \bar{L}*)
This parameter is for setting the communications parity. Set the parity to "none," "even," or "odd."
- Send Data Wait Time (*SDWT*)
The send data wait time is the delay from when the Controller receives a command from the host computer until it returns a response. If the response is returned too quickly, the host computer may not be able to receive the response. Change the send data wait time as required. To increase the response speed for communications, reduce the send data wait time. The send data wait time can be set in 1-ms increments between 0 and 99 ms. The default is 20 ms.

2

CompoWay/F Communications Procedures

Read this section if you are to communicate using the CompoWay/F format.

2-1	Data Format	2-2
2-1-1	Command Frame	2-2
2-1-2	BCC Calculation Example	2-3
2-1-3	Response Frame	2-3
2-1-4	Communications Data	2-4
2-1-5	End Code Example	2-4
2-2	Structure of Command Text	2-6
2-2-1	PDU Structure	2-6
2-2-2	Area Definitions	2-6
2-2-3	Type Code (Variable Type)	2-6
2-2-4	Addresses	2-7
2-2-5	Number of Elements	2-7
2-2-6	List of Services (Main Request Codes and Sub-Request Codes)	2-7
2-3	Detailed Description of the Services	2-8
2-3-1	Read Variable Area	2-8
2-3-2	Write Variable Area	2-9
2-3-3	Composite Read from Variable Area	2-10
2-3-4	Composite Write to Variable Area	2-12
2-3-5	Read Controller Attributes	2-13
2-3-6	Read Controller Status	2-14
2-3-7	Echoback Test	2-15
2-3-8	Operation Command	2-17
2-4	Response Code List	2-22

2-1 Data Format

Hexadecimal values are expressed by adding the prefix H' before the number, e.g., H'02. Numbers shown without the H' prefix are ASCII characters.

The number underneath each item in a frame indicates the number of bytes.

2-1-1 Command Frame

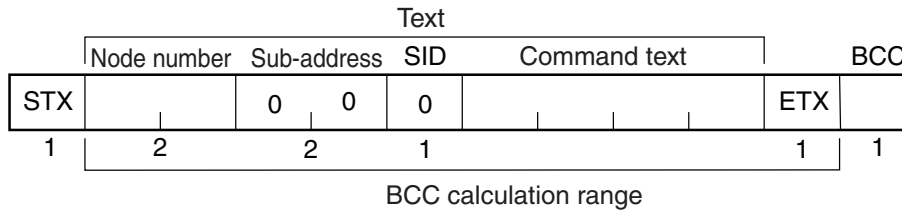

STX	This code (H'02) indicates the beginning of the communications frame (text). Always set this character in the first byte. When STX is received again during reception, reception is carried out again from the point where STX was received.
Node number	<ul style="list-style-type: none"> This number specifies the transmission's destination. Specify the E5□C-T's communications unit number. A BCD value between 00 and 99 or an ASCII value of XX can be set. Specify "XX" for a broadcast transmission. No responses will be returned for broadcast transmissions. No responses will be returned from node numbers other than the ones in the above range.
Sub-address	Always set the sub-address to "00."
SID (Service ID)	Always set the service ID to "0."
Command text	This is the command text area. For details, refer to <i>2-2 Structure of Command Text</i> .
ETX	This code (H'03) indicates the end of the text.
BCC	This is the Block Check Character. The BCC result is found by calculating the exclusive OR of the bytes from the node number up to ETX.

2-1-2 BCC Calculation Example

The BCC (Block Check Character) is determined by calculating the exclusive OR of the bytes from the node number up to ETX. The 8-bit result is written to the BCC byte at the end of the frame.

STX	Node number		Sub-address		SID	Command text			ETX	BCC	
02H	0 (30H)	0 (30H)	0 (30H)	0 (30H)	0 (30H)	0 (30H)	5 (35H)	0 (30H)	3 (33H)	03H	35H

$$BCC = 30H \oplus 30H \oplus 30H \oplus 30H \oplus 30H \oplus 30H \oplus 35H \oplus 30H \oplus 33H \oplus 03H = 35H$$

The result of the calculation (35 hex) is written to the BCC byte.

The ⊕ symbols indicate XOR (exclusive OR) operations.

2-1-3 Response Frame

	Node number		Sub-address		End code	Command text			ETX	BCC
STX		0	0							
1	2	2	2					1	1	

End code	Name	Description	Error detection priority
00	Normal completion	The command ended normally without error.	None
0F	FINS command error	The specified FINS command could not be executed. The FINS response code should indicate why the command could not be executed.	8
10	Parity error	The sum total of bits whose received data is "1" does not match the set value of the "communications parity" bit.	2
11	Framing error	Stop bit is "0."	1
12	Overrun error	An attempt was made to transfer new data when the reception data buffer was already full.	3
13	BCC error	The calculated BCC value is different from the received BCC value.	5
14	Format error	<ul style="list-style-type: none"> The command text contains characters other than 0 to 9, and A to F. This error does not apply to Echoback Tests. (Refer to 2-3-7 Echoback Test for details.) There was no SID and command text. There was no command text. "MRC/SRC" not included in command text. 	7
16	Sub-address error	<ul style="list-style-type: none"> Illegal (unsupported) sub-address There was no sub-address, SID, and command text. Sub-address was less than two characters, and there was no SID and command text 	6
18	Frame length error	The received frame exceeds the specified (supported) number of bytes.	4

- An end code is returned for each command frame received that was addressed to the local node.
- No response will be returned unless the frame contained all elements up to the ETX and BCC.
- "Error Detection Priority" indicates the priority when two or more errors occur simultaneously.

2-1-4 Communications Data

Communications format	Set (monitor) values	Negative values	Decimal point
CompoWay/F	8-digit hexadecimal	2's complement	Decimal point is removed and the result is converted to hexadecimal. Example conversion: 105.0 → 1050 → H'0000041A

2-1-5 End Code Example

The following examples show the end code when a command did not end normally.

Example 1) Illegal Sub-address, No SID, and No Command Text

- Command

	Node number	Sub-address	BCC
STX		0 A	ETX

- Response

	Node number	Sub-address	End code	BCC
STX		0 A	1 6	ETX

End code is "16" (sub-address error).

The sub-address error code is used because the sub-address error has a higher error detection priority than the format error.

Example 2) No Command Text

- Command

	Node number	Sub-address	SID	BCC
STX		0 0	0	ETX

- Response

	Node number	Sub-address	End code	BCC
STX		0 0	1 4	ETX

The end code is "14" (format error).

Example 3) No Node Number Provided

- Command

	BCC
STX	ETX

The node number is lacking one character.

- Response

There is no response.

Example 4) No Sub-address and Illegal BCC

- Command

Node number		BCC	
STX		ETX	Err

- Response

Node number		Sub-address		End code		BCC	
STX		0	0	1	3	ETX	

The sub-address is "00" and the end code is "13" (BCC error).

2-2 Structure of Command Text

2-2-1 PDU Structure

An MRC (Main Request Code) and SRC (Sub-Request Code) followed by the various required data is transferred to the command text.

- Service Request PDU

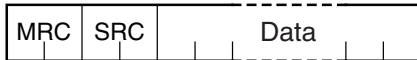

The MRES (Main Response Code) and SRES (Sub-Response Code) are transferred to the response frame following the above MRC/SRC. Data is then transferred following the MRES and SRES.

- Service Response PDU (Normal Response)

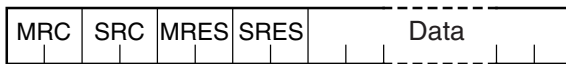

If the specified command text could not be executed, the service response PDU will contain only the MRC/SRC and MRES/SRES.

- Service Response PDU (Command Text Not Executed)

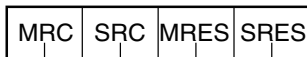

MRES/SRES provides the response code. MRES/SRES are not output when processing ends in a normal completion.

2-2-2 Area Definitions

Areas comprise only the variable area.

2-2-3 Type Code (Variable Type)

The following figure shows the variable area type code.

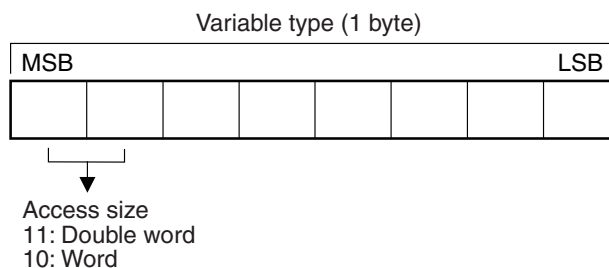

The variable type is converted to 2-byte ASCII and loaded to the frame. The following table shows the available variable types.

Variable type	Description
C0/80	R/O (read only) parameter for setup area 0.
C1/81	R/W parameter for setup area 0.
C3/83	R/W parameter for setup area 1.
C4/84	R/W parameters for setup area 0 (program setting level, currently selected number).
C5/85	R/W parameter for setup area 0.
C9/89	R/W parameter for setup area 1.
DA/9A	R/W parameters for setup area 0 (program setting level, all).

Note: Setup area 1 has no read-only parameters, so there is no variable type "C2."

The following table summarizes setup areas 0 and 1.

Area	Description
Setup area 0	This area groups together the protect, manual control, operation, program setting, adjustment, and PID setting levels.
Setting area 1	This area groups together the initial setting, communications setting, advanced function setting, and calibration levels.

The type code depends on the parameter. Refer to 3-1 Variable Area (Setting Range) List for details.

2-2-4 Addresses

An address is appended to each of the variable types. Express addresses in 2-byte hexadecimal and append them for the specified access size. The address depends on the parameter. Refer to 3-1 Variable Area (Setting Range) List for details.

2-2-5 Number of Elements

The number of elements is expressed in 2-byte hexadecimal. The range that can be specified for the number of elements depends on the command. Refer to 2-3 Detailed Description of the Services for details.

2-2-6 List of Services (Main Request Codes and Sub-Request Codes)

MRC	SRC	Name of service	Processing
01	01	Read Variable Area	This service reads from the variable area.
01	02	Write Variable Area	This service writes to the variable area.
01	04	Composite Read from Variable Area	This service reads from the variable area in the order specified by the parameters.
01	13	Composite Write to Variable Area	This service writes to the variable area in the order specified by the parameters.
05	03	Read Controller Attributes	This service reads the model number and communications buffer size.
06	01	Read Controller Status	This service reads the operating status.
08	01	Echoback Test	This service performs an echoback test.
30	05	Operation Command	This service performs operations such as RUN/RESET, executing/stopping AT (auto-tuning), and moving to setup area 1.

Note: No commands will be accepted and no responses will be returned when a memory error (RAM error) has occurred or the Controller is initializing (until the Controller recognizes the process value after the power is turned ON).

2-3 Detailed Description of the Services

2-3-1 Read Variable Area

This service reads data from the variable area.

- Service Request PDU

MRC	SRC	Variable type	Read start address	Bit position	Number of elements
0 1	0 1			0 0	
2	2	2	4	2	4

- Service Response PDU

MRC	SRC	Response code	Read data (for number of elements)
0 1	0 1		
2	2	4	Number of elements × 8 or 4

(1) Variable Type and Read Start Address

For details on variable types and read start addresses, refer to *Section 3 Communications Data for CompoWay/F*.

(2) Bit Position

Bit access is not supported. Fixed to “00.”

(3) Number of Elements

Number of elements	Processing
0000	The read operation is not performed (read data is not appended to the service response PDU), and processing ends in a normal completion.
Double word (variable types C0, C1, C3, C4, C5, C9, or DA)	The read operation is performed and processing ends in a normal completion.
Word (variable types 80, 81, 83, 84, 85, 89, or 9A)	

(4) Response Code

- Normal Completion

Response code	Name	Description
0000	Normal completion	No errors were found.

- Error Occurred

Response code	Error name	Cause
1001	Command too long	The command is too long.
1002	Command too short	The command is too short.
1101	Area type error	The variable type is wrong.
1103	Start address out-of-range error	The read start address is out of range.
110B	Response too long	The number of elements exceeds the maximum.
1100	Parameter error	Bit position is not "00."
2203	Operation error	Non-volatile memory error

(5) Precautions

- Alarm Function
Even though alarms are not displayed on the Controller's display, they function normally in communications.

2-3-2 Write Variable Area

This service writes data to the variable area.

- Service Request PD

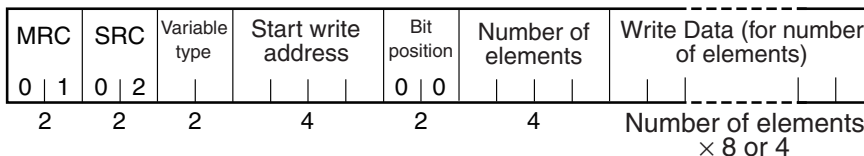

- Service Response PDU

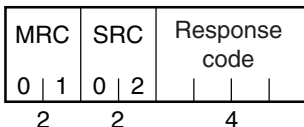

(1) Variable Type and Write Start Address

For details on variable types and write start addresses, refer to *Section 3 Communications Data for CompoWay/F*.

(2) Bit Position

Bit access is not supported. Fixed to "00."

(3) Number of Elements

Number of elements	Processing
0000	The write operation is not performed (do not append write data to the service request PDU) and processing ends in a normal completion.
Double word (variable types C1, C3, C4, C5, C9, or DA)	The write operation is performed and processing ends in a normal completion.
Word (variable types 81, 83, 84, 85, 89, or 9A)	

(4) Response Code

- Normal Completion

Response code	Name	Description
0000	Normal completion	No errors were found.

- Error Occurred

Response code	Error name	Cause
1002	Command too short	The command is too short.
1101	Area type error	The variable type is wrong.
1103	Start address out-of-range error	Write start address is out of range.
1104	End address out-of-range error	The write end address (write start address + number of elements) exceeds the final address of the variable area.
1003	Number of elements/data mismatch	The number of data does not match the number of elements.
1100	Parameter error	<ul style="list-style-type: none"> • Bit position is not "00." • The write data is out of the setting range.
3003	Read-only error	Variable type "C0" was written to.
2203	Operation error	<ul style="list-style-type: none"> • The Communications Writing parameter is set to "OFF" (disabled). • Attempted to write to a parameter in setup area 1 from setup area 0. • Attempted to write to a protect parameter from other than the protect level. • AT (auto-tuning) was in progress. * • Non-volatile memory error • The Program No. parameter was written during operation.

* For details on AT (auto-tuning), refer to the *E5□C-T Digital Temperature Controllers User's Manual* (Cat. No. H185).

(5) Precautions

- Alarm Function

Even though alarms are not displayed on the Controller's display, they function normally in communications.

2-3-3 Composite Read from Variable Area

This service reads in order the contents of specified addresses in the variable area.

- Service Request PDU

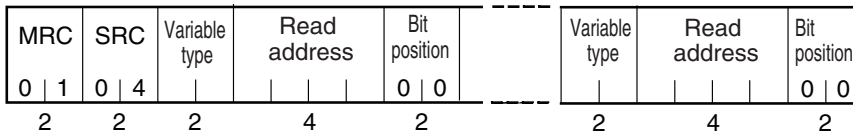

- Service Response PDU

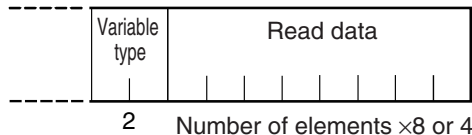
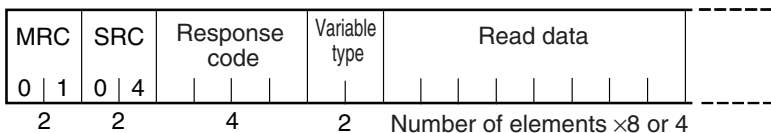

Note: The read data is read together with the variable type in the order specified by the command.

(1) Variable Type and Read Start Address

For details on variable types and read start addresses, refer to *Section 3 Communications Data for CompoWay/F*.

(2) Bit Position

Bit access is not supported. Fixed to “00.”

(3) Number of Read Data Items (Variable Type + Read Data + Bit Position Counted As 1 Item)

Read data length	Number of read data items
Double word (variable types C0, C1, C3, C4, C5, C9, or DA)	20 max.
Word (variable types 80, 81, 83, 84, 85, 89, or 9A)	25 max.

Note: The following table gives the maximum number of read data items when double-word data and word data are used together.

Composite Read		Composite Read	
Double word (variable types C0, C1, C3, C4, C5, C9, or DA)	Word (variable types 80, 81, 83, 84, 85, 89, or 9A)	Double word (variable types C0, C1, C3, C4, C5, C9, or DA)	Word (variable types 80, 81, 83, 84, 85, 89, or 9A)
20	0	11	14
19	1	10	15
18	2	9	16
18	3	8	17
17	4	7	18
17	5	6	19
16	6	8	20
15	7	4	21
15	8	3	22
14	9	2	23
14	10	1	24
13	11	0	25
12	12		
12	13		

(4) Response Code

- Normal Completion

Response code	Name	Description
0000	Normal completion	No errors were found.

- Error Occurred

Response code	Error name	Cause
1002	Command too short	The command is too short.

Response code	Error name	Cause
1101	Area type error	The variable type is wrong.
110B	Response too long	The number of elements exceeds the maximum.
1100	Parameter error	Bit position is not "00."
2203	Operation error	Non-volatile memory error

2-3-4 Composite Write to Variable Area

This service writes in order the contents of specified addresses to a variable area.

- Service Request PDU

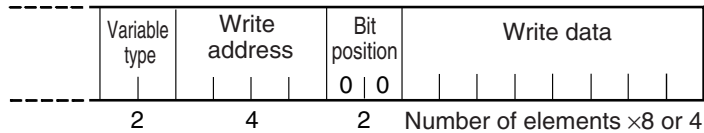
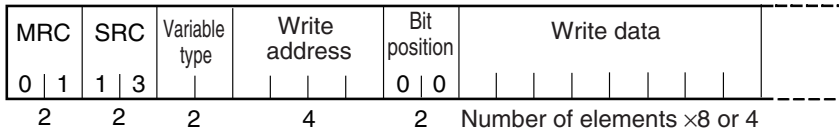

- Service Response PDU

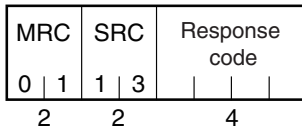

(1) Variable Type and Write Start Address

For details on variable types and write start addresses, refer to *Section 3 Communications Data for CompoWay/F*.

(2) Bit Position

Bit access is not supported. Fixed to "00."

(3) Number of Write Data Items (Variable Type + Write Address + Bit Position + Write Data Counted As 1 Item)

Write data length	Number of write data items
Double word (variable types C1, C3, C4, C5, C9, or DA)	12 max.
Word (variable types 81, 83, 84, 85, 89, or 9A)	17 max.

Note: The following table gives the maximum number of write data items when double-word data and word data are used together.

Composite Write		Composite Write	
Double word (variable types C1, C3, C4, C5, C9, or DA)	Word (variable types 81, 83, 84, 85, 89, or 9A)	Double word (variable types C1, C3, C4, C5, C9, or DA)	Word (variable types 81, 83, 84, 85, 89, or 9A)
12	0	5	10
12	1	4	11
11	2	3	12
10	3	3	13
9	4	2	14
9	5	1	15

Composite Write	
Double word (variable types C1, C3, C4, C5, C9, or DA)	Word (variable types 81, 83, 84, 85, 89, or 9A)
8	6
7	7
6	8
6	9

Composite Write	
Double word (variable types C1, C3, C4, C5, C9, or DA)	Word (variable types 81, 83, 84, 85, 89, or 9A)
0	16
0	17

(4) Response Code

- Normal Completion

Response code	Name	Description
0000	Normal completion	No errors were found.

- Error Occurred

Response code	Error name	Cause
1002	Command too short	The command is too short.
1101	Area type error	The variable type is wrong.
1100	Parameter error	<ul style="list-style-type: none"> • Bit position is not "00." • The write data is out of the setting range.
3003	Read-only error	Variable type "C0" was written to.
2203	Operation error	<ul style="list-style-type: none"> • The Communications Writing parameter is set to "OFF" (disabled). • Attempted to write to a parameter in setup area 1 from setup area 0. • Attempted to write to a protect parameter from other than the protect level. • AT (auto-tuning) was in progress. * • Non-volatile memory error • The Program No. parameter was written during operation.

* For details on AT (auto-tuning), refer to the *E5□C-T Digital Temperature Controllers User's Manual* (Cat. No. H185).

2-3-5 Read Controller Attributes

This service reads the model number and communications buffer size.

- Service Request PDU

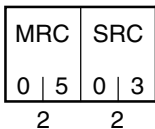

- Service Response PDU

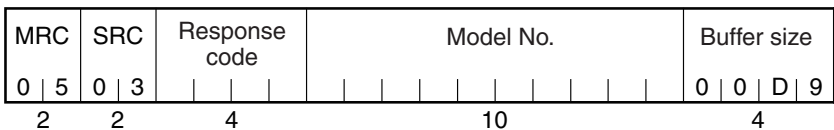

(1) Model Number

The model number is expressed in 10-byte ASCII.

Example: The model is given as shown below for the E5CC-TRX3ASM-000 (relay output, 3 auxiliary outputs, and no options).

E	5	C	C	-	T	R	X	3	A
---	---	---	---	---	---	---	---	---	---

(2) Buffer Size

The communications buffer size is expressed in 2-byte hexadecimal, and read after being converted to 4-byte ASCII.

Buffer size: 217 bytes (= H'00D9)

(3) Response Code

- Normal Completion

Response code	Name	Description
0000	Normal completion	No errors were found.

- Error Occurred

Response code	Error name	Description
1001	Command too long	The command is too long.
2203	Operation error	Non-volatile memory error

2-3-6 Read Controller Status

This service reads the operating status and error status.

- Service Request PDU

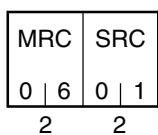

- Service Response PDU

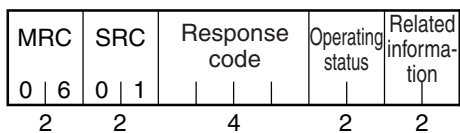

(1) Operating Status

Operating status	Description
01	Control is not being performed (the manual MV, MV at reset, or MV at PV error from setup area 1 is being output).
00	Control is being carried out (state other than the above).

(2) Related Information

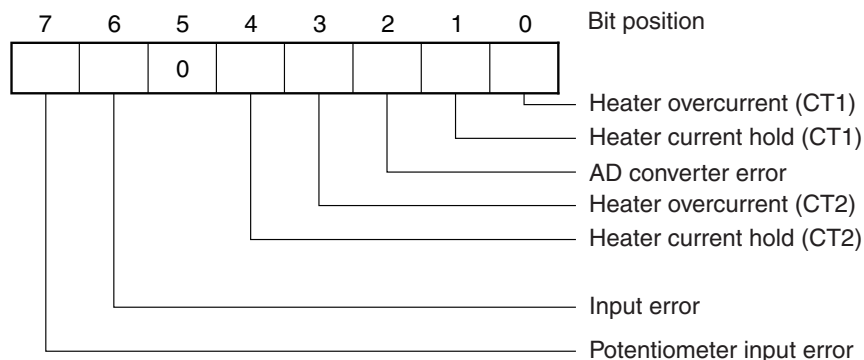

(3) Response Code

- Normal Completion

Response code	Name	Description
0000	Normal completion	No errors were found.

- Error Occurred

Response code	Error name	Description
1001	Command too long	The command is too long.
2203	Operation error	Non-volatile memory error

2-3-7 Echoback Test

This service performs an echoback test.

- Service Request PDU

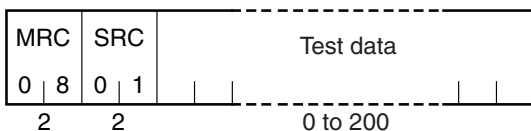

- Service Response PDU

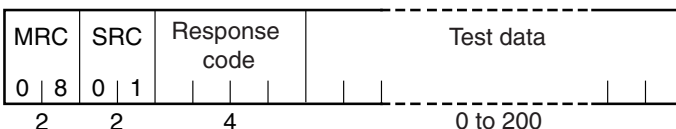

(1) Test Data

Set between 0 and 200 bytes of user-defined test data.

Set a value for the test data within the ranges shown below according to the communications data length.

Communications data length	Test Data
8 bits	ASCII data: H'20 to H'7E or H'A1 to H'FE
7 bits	ASCII data: H'20 to H'7E

(2) Response Code

- Normal Completion

Response code	Name	Description
0000	Normal completion	No errors were found.

- Error Occurred

Response code	Error name	Description
1001	Command too long	The command is too long.
2203	Operation error	Non-volatile memory error

2-3-8 Operation Command

- Communications Writing
- Write Mode
- Move to Setup Area 1
- Parameter Initialization
- Invert Direct/Reverse Operation
- RUN/RESET
- Save RAM Data
- Move to Protect Level
- Alarm Latch Cancel
- Hold
- AT Execute/Cancel
- Software Reset
- Auto/Manual Switch
- SP Mode
- Advance

- Service Request PDU

MRC	SRC	Com- mand code	Related informa- tion
3 0	0 5		
2	2	2	2

- Service Response PDU

MRC	SRC	Response code
3 0	0 5	
2	2	4

(1) Command Code and Related Information

Command code	Command content	Related Information
00	Communications Writing	00: OFF (disabled) 01: ON (enabled)
01	RUN/RESET	00: Run 01: RESET
03	AT Execute/Cancel	0E: All PID 40% AT Execute 0F: All PID 100% AT Execute 00: AT cancel 01: 100% AT execute 02: 40% AT execute
04	Write Mode	00: Backup 01: RAM write mode
05	Save RAM Data	00
06	Software Reset	00
07	Move to Setup Area 1	00
08	Move to Protect Level	00
09	Auto/Manual Switch	00: Automatic mode 01: Manual mode
0B	Parameter Initialization	00
0C	Alarm Latch Cancel	00: Alarm 1 latch cancel 01: Alarm 2 latch cancel 02: Alarm 3 latch cancel 03: HB alarm latch cancel 04: HS alarm latch cancel 05: Alarm 4 latch cancel 0F: All alarm latch cancel
0D	SP Mode	00: Program SP mode 01: Fixed SP mode
0E	Invert Direct/Reverse Operation	00: Not invert 01: Invert

Command code	Command content	Related Information
13	Hold	00: Clear hold 01: Hold
14	Advance	00

(2) Response Code

- Normal Completion

Response code	Name	Description
0000	Normal completion	No errors were found.

- Error Occurred

Response code	Error name	Description
1001	Command too long	The command is too long.
1002	Command too short	The command is too short.
1100	Parameter error	Command code and related information are wrong.
2203	Operation error	<ul style="list-style-type: none"> • The Communications Writing parameter is set to "OFF" (disabled). The command is received regardless of the Communications Writing parameter setting (ON/OFF). • Processing could not be performed. For details, refer to (3) <i>Operation Commands and Precautions</i> below. • Non-volatile memory error

(3) Operation Commands and Precautions

- Communications Writing

Set the Communications Writing parameter to "ON: enabled" or "OFF: disabled" with the related information setting. The setting can be accepted in both setup area 0 and setup area 1. An operation error will occur, however, if enabling or disabling communications writing is set for an event input.

- RUN/RESET

Set the related information to select starting or stopping program operation. The setting can be accepted in both setup area 0 and setup area 1.

- AT Execute/Cancel

Set AT (auto-tuning) to "execute" or "cancel" with the related information setting. This command can be accepted in setup area 0 only. An "operation error" will be generated in the following instances:

- When the RUN/RESET parameter is set to RESET (and the reset operation is set to stop control).
- During standby status (when the reset operation is set to stop control).
- In manual mode or when executing from setup area 1.
- When ON/OFF control is being used
- When an attempt is made to execute another type of AT during AT execution
Example: When 40% AT is specified during 100% AT execution.

A parameter error will occur if 40% AT is specified during heating and cooling control or floating position-proportional control.

Note: If the same type of AT execution is specified during AT execution (e.g., if 100% AT is specified during 100% AT execution), the AT will not be restarted and the operation will end in normal completion with no processing.

- Write Mode

Set either the backup mode or RAM write mode with the related information setting. The setting can be accepted in both setup area 0 and setup area 1.

The number of non-volatile memory write operations is limited. Therefore, use RAM write mode when frequently overwriting data.

Write mode	Description
Backup mode	The data is written to non-volatile memory when the parameters in the operation, program setting, adjustment, and PID setting levels (excluding read-only parameters) are written by communications.
RAM write mode	The data is not written to non-volatile memory when the parameters in the operation, program setting, adjustment, and PID setting levels (excluding read-only parameters) are written by communications.

- When the mode is switched from RAM write mode to backup mode, the parameters in the operation, program setting, adjustment, and PID setting levels (excluding read-only parameters) are written to non-volatile memory.
- The RAM write mode is enabled only when the Communications Writing parameter is set to "ON" (enabled).
Consequently, when the Communications Writing parameter setting is changed to "OFF" (disabled), the parameters in the operation/adjustment levels (excluding read-only parameters) are written to non-volatile memory even if the mode is set to RAM write mode.

- Save RAM Data

This command writes the parameters in the operation, program setting, adjustment, and PID setting levels (excluding read-only parameters) to non-volatile memory. The setting can be accepted in both setup area 0 and setup area 1.

- Software Reset

Restarts processing from the point when power is turned ON. The setting can be accepted in both setup area 0 and setup area 1.

- Move to Setup Area 1

This command moves to "setup area 1" and can be accepted at both setup areas 0 and 1. If the "initial setting/communications protect" is set to "2," an "operation error" will be generated, and the move to setup area 1 will be prohibited.

When this move is carried out from setup area 0, the display indicates the Input Type parameter in the "initial setting level." When this operation command is executed in setup area 1, the display will not change.

- Move to Protect Level

This command moves to the "protect level" and can be accepted only in setup area 0. When this command is issued in setup area 1, an "operation error" will be generated, and the move to the protect level will be prohibited.

- Moving to Protect Level in Manual Mode

When this operation command is issued in manual mode, an "operation error" will be generated, and the move to the protect level will be prohibited.

- Auto/Manual Switch

This operation command switches the mode to manual mode or automatic mode, based on the related information setting. When the Controller is switched to manual mode, the “manual control level” will be displayed. When the Controller is switched from manual mode to automatic mode, the operation level’s first parameter will be displayed. When the Controller is switched to manual mode while already in manual mode, the command will be completed normally and the display will not change (the contents will not be refreshed). The setting can be made in setup area 0.

An operation error will occur in the following situations.

- When the command is executed in “setup area 1”
- When auto/manual is set for an event input
- Switching to Manual Mode during Auto-tuning
If the mode is switched during auto-tuning (AT), the AT will be cancelled and the Controller will be switched to manual mode.

- Parameter Initialization

The present settings are returned to the default values and written to non-volatile memory. This command can be accepted in setup area 1 only. When this command is issued in setup area 0, an “operation error” will be generated. (These settings are the same as the ones used when “FACT” is selected for the setting data's set value initialization.)

- Alarm Latch Cancel

The applicable alarm latch can be cleared with the related information setting. The setting can be accepted in both setup area 0 and setup area 1. An operation error will occur if communications writing is disabled or if a non-volatile memory error occurs.

- SP Mode

Select the program SP mode or fixed SP mode with the related information setting. The setting can be accepted in both setup area 0 and setup area 1. An operation error will occur in the following situations.

- When AT is being executed
- When the SP Mode parameter is disabled (not displayed at the Controller)

- Invert Direct/Reverse Operation

Inverting or not inverting direct/reverse operation can be selected with the related information setting. The setting can be accepted in both setup area 0 and setup area 1. The related information specifications are written to non-volatile memory according to the write mode settings.

An operation error will occur in the following situations:

- When AT is being executed.
- When inverting direct/reverse operation is set for an event input.
- When executed in manual mode.

- Setting Areas

Control operation is executed in setting area 0. In this state, you can perform operations that are permitted only during control or those that cause no problems even if control is in progress. These operations include reading PVs, writing SPs, and changing RUN/RESET status.

Setting area 0, however, prohibits operations that affect control, including writing data at the initial setting level. (Reading setting data is always allowed.)

In setting area 1, control operation is stopped. In this state, you can perform operations that are not allowed in setting area 0. These operations include writing data at the initial setting level.

At power-ON, the Digital Controller is set in setting area 0. To move to setting area 1, use the

"move-to-setting area 1" command. To return to setting area 0, turn the power OFF and ON again, or use the "software reset" command.

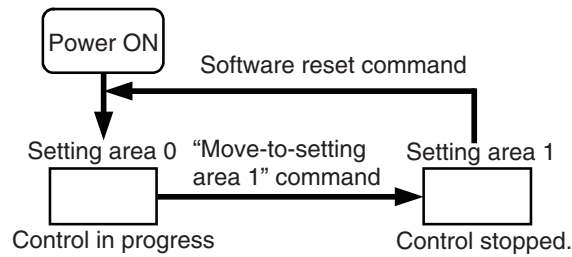

- Hold

Turn the hold operation ON or OFF with the related information setting. This command can be accepted in setup area 0 only. An operation error will occur in the following situations.

- When AT is being executed
- During standby status
- During a reset or when continuing control at the end of operation
- When Hold/Clear Hold is assigned to an event input

- Advance

This operation command performs the advance operation. This command can be accepted in setup area 0 only. An operation error will occur in the following situations.

- When AT is being executed
- During standby status
- During a reset or when continuing control at the end of operation

2-4 Response Code List

Normal Completion

Response code	Name	Description	Error detection priority
0000	Normal completion	No errors were found.	None

Error Occurred

Response code	Name	Description
0401	Unsupported command	The service function for the relevant command is not supported.
1001	Command too long	The command is too long.
1002	Command too short	The command is too short.
1101	Area type error	Wrong variable type
1103	Start address out-of-range error	The read/write start address is out of range.
1104	End address out-of-range error	The write end address (write start address + number of elements) exceeds the final address of the variable area.
1003	Number of elements/data mismatch	The amount of data does not match the number of elements.
110B	Response too long	The response length exceeds the communications buffer size (when the number of elements is greater than the maximum number of elements for that service).
1100	Parameter error	<ul style="list-style-type: none"> • Bit position is not "00." • The write data is out of the setting range. • The command code or related information in the operation command is wrong.
3003	Read-only error	Variable type "C0" was written to.
2203	Operation error	<ul style="list-style-type: none"> • The Communications Writing parameter is set to "OFF" (disabled). • Attempted to write to a parameter in setup area 1 from setup area 0. • Attempted to write to a protect parameter from other than the protect level. • Writing was carried out during AT execution. • Processing is not possible by operation command. • Non-volatile memory error

3

Communications Data for CompoWay/F

This section lists the details of the communications data in the CompoWay/F communications protocol.

3-1 Variable Area (Setting Range) List	3-2
3-2 Status and Status 2	3-31

3-1 Variable Area (Setting Range) List

- For communications using a variable type not enclosed in parentheses in the following table, the set value is double-word data (8 digits). For communications using a variable type enclosed in parentheses, the set value is single-word data (4 digits).
- For example, variable type C0 is double-word data (8 digits), and variable type 80 is single-word data (4 digits).
- Items expressed in hexadecimal in the "Setting (monitor) value" column are the setting range for CompoWay/F communications. The values in parentheses are the actual setting range. When there is a section reference for a setting item, refer to that reference for details.

Variable type	Address	Parameter name	Setting (monitor) value	Level		
C0 (80)	0000	PV	Temperature: Use the specified range for each sensor. Analog: Scaling lower limit –5% FS to Scaling upper limit +5% FS	Operation		
C0 (80)	0001	Status ^{*1} *2	Refer to 3-2 <i>Status and Status 2</i> for details.			
C0 (80)	0002	Present SP ^{*1}	SP lower limit to SP upper limit			
C0 (80)	0003	Heater Current 1 Value Monitor	H'00000000 to H'00000226 (0.0 to 55.0)			
C0 (80)	0004	MV Monitor (Heating)	Standard: H'FFFFFFCE to H'0000041A (–5.0 to 105.0) Heating and cooling: H'00000000 to H'0000041A (0.0 to 105.0)			
C0 (80)	0005	MV Monitor (Cooling)	H'00000000 to H'0000041A (0.0 to 105.0)			
C0 (80)	0006	Heater Current 2 Value Monitor	H'00000000 to H'00000226 (0.0 to 55.0)			
C0 (80)	0007	Leakage Current 1 Monitor	H'00000000 to H'00000226 (0.0 to 55.0)			
C0 (80)	0008	Leakage Current 2 Monitor	H'00000000 to H'00000226 (0.0 to 55.0)			
C0 (80)	000A	Valve Opening Monitor	H'FFFFFF9C to H'0000044C (–10.0 to 110.0)			
C0 (80)	000D	PID Set No. Monitor	H'00000001 to H'00000008 (1 to 8)		None	
C0 (80)	000E	Decimal Point Monitor ^{*1}	H'00000000 to H'00000003 (0 to 3)			Operation
C0 (80)	0011	Status 2 ^{*1} *2	Refer to 3-2 <i>Status and Status 2</i> .			
C0 (80)	0012	Status ^{*1} *3	Refer to 3-2 <i>Status and Status 2</i> .			
C0 (80)	0013	Status 2 ^{*1} *3	Refer to 3-2 <i>Status and Status 2</i> .			
C0 (80)	0014	Program No. Monitor ^{*4}	H'00000000 to H'00000007 (0 to 7)			
C0 (80)	0015	Segment No. Monitor	H'00000000 to H'0000001F (0 to 31)			

*1 Not displayed on the Controller display.

*2 When the variable type is 80 (word access), the rightmost 16 bits are read.

*3 When the variable type is 80 (word access), the leftmost 16 bits are read.

*4 If the RUN/RESET parameter is set to RUN, the current program number will be read.

If the RUN/RESET parameter is set to RESET, the program number that is set in the Program No. parameter will be read.

Variable type	Address	Parameter name	Setting (monitor) value	Level
C0 (80)	0016	Remaining Standby Time Monitor	H'00000000 to H'00009959 (hours, minutes) H'00000000 to H'00009923 (days, hours)	Operation
C0 (80)	0017	Elapsed Program Time Monitor	H'00000000 to H'00009959	
C0 (80)	0018	Remaining Program Time Monitor	H'00000000 to H'00009959	None
C0 (80)	0019	Elapsed Segment Time Monitor	H'00000000 to H'00009959	
C0 (80)	001A	Remaining Segment Time Monitor	H'00000000 to H'00009959	
C0 (80)	001B	Program Repetitions Monitor	H'00000000 to H'0000270F (0 to 9999)	Operation
C0 (80)	001C	SP Mode Setting Monitor (SP Mode)	H'00000000 (0): Program SP mode H'00000001 (1): Fixed SP mode	Adjustment

Variable type	Address	Parameter name	Setting (monitor) value	Level
C1 (81)	0000	Operation/Adjustment Protect	H'00000000 (0) to H'00000005 (5) 0: No control 1: Operation level (PV displayed, PV/SP allowed, others allowed), program level allowed, adjustment level allowed, PID setting level prohibited 2: Operation level (PV displayed, PV/SP allowed, others allowed), program level allowed, adjustment level prohibited, PID setting level prohibited 3: Operation level (PV displayed, PV/SP allowed, others allowed), program level prohibited, adjustment level prohibited, PID setting level prohibited 4: Operation level (PV displayed, PV/SP allowed, others prohibited), program level prohibited, adjustment level prohibited, PID setting level prohibited 5: Operation level (PV displayed, PV/SP displayed, others prohibited), program level prohibited, adjustment level prohibited, PID setting level prohibited	Protect
C1 (81)	0001	Initial Setting/Communications Protect	H'00000000 (0): Move to initial setting/communications setting level is allowed. (Move to advanced function setting level is displayed.) H'00000001 (1): Move to initial setting/communications setting level is allowed. (Move to advanced function setting level is not displayed.) H'00000002 (2): Move to initial setting/communications setting level is prohibited.	
C1 (81)	0002	Setting Change Protect	H'00000000 (0): OFF (Changing of setup on Controller display is allowed.) H'00000001 (1): ON (Changing of setup on Controller display is prohibited.)	
C1 (81)	000D	Heater Burnout Detection 1	H'00000000 to H'000001F4 (0.0 to 50.0)	Adjustment
C1 (81)	0012	Process Value Input Shift	H'FFFFFF831 to H'0000270F (-1999 to 9999)	
C1 (81)	0013	PV Slope Coefficient	H'00000001 to H'0000270F (0.001 to 9.999)	
C1 (81)	0015	Proportional Band ^{*1}	H'00000001 to H'0000270F (0.1 to 999.9)	

*1 The parameter for the currently selected PID set will be accessed. For setup area 1, however, the currently selected PID set is fixed at PID1.

Variable type	Address	Parameter name	Setting (monitor) value	Level
C1 (81)	0016	Integral Time ^{*1}	Standard, heating/cooling, or close position-proportional control: H'00000000 to H'0000270F (0 to 9999: Integral/derivative time unit is 1 s.) (0.0 to 999.9: Integral/derivative time unit is 0.1 s.) Floating position-proportional control: H'00000001 to H'0000270F (1 to 9999: Integral/derivative time unit is 1 s.) (0.1 to 999.9: Integral/derivative time unit is 0.1 s.)	Adjustment
C1 (81)	0017	Derivative Time ^{*1}	H'00000000 to H'0000270F (0 to 9999: Integral/derivative time unit is 1 s.) (0.0 to 999.9: Integral/derivative time unit is 0.1 s.)	
C1 (81)	0019	Dead Band	H'FFFFFF831 to H'0000270F (-199.9 to 999.9 for temperature input) (-19.99 to 99.99 for analog input)	
C1 (81)	001A	Manual Reset Value	H'00000000 to H'000003E8 (0.0 to 100.0)	
C1 (81)	001B	Hysteresis (Heating)	H'00000001 to H'0000270F (0.1 to 999.9 for temperature input) (0.01 to 99.99 for analog input)	
C1 (81)	001C	Hysteresis (Cooling)	H'00000001 to H'0000270F (0.1 to 999.9 for temperature input) (0.01 to 99.99 for analog input)	
C1 (81)	001D	Heater Burnout Detection 2	H'00000000 to H'000001F4 (0.0 to 50.0)	
C1 (81)	001E	HS Alarm 1	H'00000000 to H'000001F4 (0.0 to 50.0)	
C1 (81)	001F	HS Alarm 2	H'00000000 to H'000001F4 (0.0 to 50.0)	
C1 (81)	0021	Wait Band	H'00000000 (0): OFF H'00000001 to H'0000270F (0.1 to 999.9 for temperature input) (0.01 to 99.99 for analog input)	
C1 (81)	0022	MV at Reset	Standard Models	
C1 (81)	0023	MV at PV Error	Standard control: H'FFFFFFCE to H'0000041A (-5.0 to 105.0) Heating and cooling control: H'FFFFFFBE6 to H'0000041A (-105.0 to 105.0) Position-proportional Models Close position-proportional control with the Direct Setting of Position Proportional MV parameter set to ON: H'FFFFFFCE to H'0000041A (-5.0 to 105.0) Floating position-proportional control or the Direct Setting of Position Proportional MV parameter set to OFF: H'FFFFFFF to H'00000001 (-1 to 1)	

Note: The alarm function can also be used in Digital Controllers without auxiliary output terminals. In this case, confirm alarm occurrences via the status data.

*1 The parameter for the currently selected PID set will be accessed. For setup area 1, however, the currently selected PID set is fixed at PID1.

Variable type	Address	Parameter name	Setting (monitor) value	Level
C1 (81)	0024	Manual MV	Standard Models Standard control: H'FFFFFFCE to H'0000041A (-5.0 to 105.0) Heating and cooling control: H'FFFFFFBE6 to H'0000041A (-105.0 to 105.0) Position-proportional Models Close position-proportional control with the Direct Setting of Position Proportional MV parameter set to ON: H'FFFFFFCE to H'0000041A (-5.0 to 105.0)	Manual Control
C1 (81)	0026	MV Upper Limit* ¹	Standard control or close position-proportional control: MV lower limit + 0.1 to H'0000041A (MV lower limit + 0.1 to 105.0) Heating and cooling control: H'00000000 to H'0000041A (0.0 to 105.0)	Adjustment
C1 (81)	0027	MV Lower Limit* ¹	Standard control or close position-proportional control: H'FFFFFFCE to MV upper limit - 0.1 (-5.0 to MV upper limit - 0.1) Heating and cooling control: H'FFFFFFBE6 to H'00000000 (-105.0 to 0.0)	
C1 (81)	0028	Move to Protect Level	H'FFFFFF831 to H'0000270F (-1999 to 9999)	Protect
C1 (81)	0029	Password to Move to Protect Level	H'FFFFFF831 to H'0000270F (-1999 to 9999) (Can only be set. The monitor value is always H'00000000.)	
C1 (81)	002A	Parameter Mask Enable	H'00000000 (0): OFF H'00000001 (1): ON	
C1 (81)	002B	PF Key Protect	H'00000000 (0): OFF H'00000001 (1): ON	
C1 (81)	002C	MV Change Rate Limit	H'00000000 to H'000003E8 (0.0 to 100.0)	Adjustment
C1 (81)	002D	Position Proportional Dead Band	H'00000001 to H'00000064 (0.1 to 10.0)	
C1 (81)	002E	Open/Close Hysteresis	H'00000001 to H'000000C8 (0.1 to 20.0)	
C1 (81)	0031	Extraction of Square Root Low-cut Point	H'00000000 to H'000003E8 (0.0 to 100.0)	
C1 (81)	0039	Proportional Band (Cooling)* ¹	H'00000001 to H'0000270F (0.1 to 999.9)	
C1 (81)	003A	Integral Time (Cooling)* ¹	H'00000000 to H'0000270F (0 to 9999: Integral/derivative time unit is 1 s.) (0.0 to 999.9: Integral/derivative time unit is 0.1 s.)	
C1 (81)	003B	Derivative Time (Cooling)* ¹	H'00000000 to H'0000270F (0 to 9999: Integral/derivative time unit is 1 s.) (0.0 to 999.9: Integral/derivative time unit is 0.1 s.)	
C1 (81)	003D	Work Bit 1 ON Delay	H'00000000 to H'0000270F (0 to 9999)	
C1 (81)	003E	Work Bit 1 OFF Delay	H'00000000 to H'0000270F (0 to 9999)	

*¹ The parameter for the currently selected PID set will be accessed. For setup area 1, however, the currently selected PID set is fixed at PID1.

Variable type	Address	Parameter name	Setting (monitor) value	Level
C1 (81)	003F	Work Bit 2 ON Delay	H'00000000 to H'0000270F (0 to 9999)	Adjustment
C1 (81)	0040	Work Bit 2 OFF Delay	H'00000000 to H'0000270F (0 to 9999)	
C1 (81)	0041	Work Bit 3 ON Delay	H'00000000 to H'0000270F (0 to 9999)	
C1 (81)	0042	Work Bit 3 OFF Delay	H'00000000 to H'0000270F (0 to 9999)	
C1 (81)	0043	Work Bit 4 ON Delay	H'00000000 to H'0000270F (0 to 9999)	
C1 (81)	0044	Work Bit 4 OFF Delay	H'00000000 to H'0000270F (0 to 9999)	
C1 (81)	0045	Work Bit 5 ON Delay	H'00000000 to H'0000270F (0 to 9999)	
C1 (81)	0046	Work Bit 5 OFF Delay	H'00000000 to H'0000270F (0 to 9999)	
C1 (81)	0047	Work Bit 6 ON Delay	H'00000000 to H'0000270F (0 to 9999)	
C1 (81)	0048	Work Bit 6 OFF Delay	H'00000000 to H'0000270F (0 to 9999)	
C1 (81)	0049	Work Bit 7 ON Delay	H'00000000 to H'0000270F (0 to 9999)	
C1 (81)	004A	Work Bit 7 OFF Delay	H'00000000 to H'0000270F (0 to 9999)	
C1 (81)	004B	Work Bit 8 ON Delay	H'00000000 to H'0000270F (0 to 9999)	
C1 (81)	004C	Work Bit 8 OFF Delay	H'00000000 to H'0000270F (0 to 9999)	
C1 (81)	004E	Program No.	H'00000000 to H'00000007 (0 to 7)	Operation
C1 (81)	004F	Fixed SP	SP lower limit to SP upper limit	
C1 (81)	0050	Standby Time	H'00000000 to H'00009959 (hours, minutes) H'00000000 to H'00009923 (days, hours)	
C1 (81)	0051	Program SP Shift Value	H'FFFFFF831 to H'0000270F (-1999 to 9999)	Adjustment

Variable type	Address	Parameter name	Setting (monitor) value	Level
C3 (83)	0000	Input Type	H'00000000 (0): Pt (–200 to 850°C/–300 to 1500°F) H'00000001 (1): Pt (–199.9 to 500.0°C/–199.9 to 900.0°F) H'00000002 (2): Pt (0.0 to 100.0°C/0.0 to 210.0°F) H'00000003 (3): JPt (–199.9 to 500.0°C/–199.9 to 900.0°F) H'00000004 (4): JPt (0.0 to 100.0°C/0.0 to 210.0°F) H'00000005 (5): K (–200 to 1300°C/–300 to 2300°F) H'00000006 (6): K (–20.0 to 500.0°C/0.0 to 900.0°F) H'00000007 (7): J (–100 to 850°C/–100 to 1500°F) H'00000008 (8): J (–20.0 to 400.0°C/0.0 to 750.0°F) H'00000009 (9): T (–200 to 400°C/–300 to 700°F) H'0000000A (10): T (–199.9 to 400.0°C/–199.9 to 700.0°F) H'0000000B (11): E (–200 to 600°C/–300 to 1100°F) H'0000000C (12): L (–100 to 850°C/–100 to 1500°F) H'0000000D (13): U (–200 to 400°C/–300 to 700°F) H'0000000E (14): U (–199.9 to 400.0°C/–199.9 to 700.0°F) H'0000000F (15): N (–200 to 1300°C/–300 to 2300°F) H'00000010 (16): R (0 to 1700°C/0 to 3000°F) H'00000011 (17): S (0 to 1700°C/0 to 3000°F) H'00000012 (18): B (100 to 1800°C/300 to 3200°F) H'00000013 (19): W (0 to 2300°C/0 to 3200°F) H'00000014 (20): PL II (0 to 1300°C/0 to 2300°F) H'00000015 (21): Infrared temperature sensor (K 140°F/60°C) H'00000016 (22): Infrared temperature sensor (K 240°F/120°C) H'00000017 (23): Infrared temperature sensor (K 280°F/140°C) H'00000018 (24): Infrared temperature sensor (K 440°F/220°C) H'00000019 (25): 4 to 20 mA H'0000001A (26): 0 to 20 mA H'0000001B (27): 1 to 5 V H'0000001C (28): 0 to 5 V H'0000001D (29): 0 to 10 V	Initial setting
C3 (83)	0001	Scaling Upper Limit	Scaling lower limit + 1 to H'0000270F (Scaling lower limit + 1 to 9,999)	
C3 (83)	0002	Scaling Lower Limit	H'FFFFFF831 to Scaling upper limit – 1 (–1999 to Scaling upper limit – 1)	
C3 (83)	0003	Decimal Point	H'00000000 to 00000003 (0 to 3)	
C3 (83)	0004	Temperature Unit	H'00000000 (0): °C H'00000001 (1): °F	
C3 (83)	0005	SP Upper Limit	The range of values (without decimal point) is as follows: Temperature input: SP lower limit + 1 to Input range upper limit Analog input: SP lower limit + 1 to Scaling upper limit	
C3 (83)	0006	SP Lower Limit	The range of values (without decimal point) is as follows: Temperature input: Input range lower limit to SP upper limit – 1 Analog input: Scaling lower limit to SP upper limit – 1	

Variable type	Address	Parameter name	Setting (monitor) value	Level
C3 (83)	0007	PID ON/OFF	H'00000000 (0): ON/OFF H'00000001 (1): 2 PID control	Initial setting
C3 (83)	0008	Standard or Heating/Cooling	H'00000000 (0): Standard H'00000001 (1): Heating and cooling	
C3 (83)	000A	Control Period (Heating)	H'FFFFFFFE (-2): 0.1 s H'FFFFFFF (-1): 0.2 s H'00000000 (0): 0.5 s H'00000001 to H'00000063 (1 to 99)	
C3 (83)	000B	Control Period (Cooling)	H'FFFFFFFE (-2): 0.1 s H'FFFFFFF (-1): 0.2 s H'00000000 (0): 0.5 s H'00000001 to H'00000063 (1 to 99)	
C3 (83)	000C	Direct/Reverse Operation	H'00000000 (0): Reverse operation H'00000001 (1): Direct operation	
C3 (83)	000D	Alarm 1 Type	H'00000000 (0): Alarm function OFF H'00000001 (1): Upper and lower-limit alarm H'00000002 (2): Upper-limit alarm H'00000003 (3): Lower-limit alarm H'00000004 (4): Upper and lower-limit range alarm H'00000005 (5): Upper and lower-limit alarm with standby sequence H'00000006 (6): Upper-limit alarm with standby sequence H'00000007 (7): Lower-limit alarm with standby sequence H'00000008 (8): Absolute-value upper-limit alarm H'00000009 (9): Absolute-value lower-limit alarm H'0000000A (10): Absolute-value upper-limit alarm with standby sequence H'0000000B (11): Absolute-value lower-limit alarm with standby sequence H'0000000C (12): LBA (Loop Burnout Alarm) H'0000000D (13): PV change rate alarm H'0000000E (14): SP absolute-value upper-limit alarm H'0000000F (15): SP absolute-value lower-limit alarm H'00000010 (16): MV absolute-value upper-limit alarm H'00000011 (17): MV absolute-value lower-limit alarm	
C3 (83)	000E	Alarm 2 Type	H'00000000 to H'00000011 (0 to 17) Note: Same settings as the Alarm 1 Type. However, the LBA (loop burnout alarm) cannot be set.	
C3 (83)	000F	Alarm 3 Type	H'00000000 to H'00000011 (0 to 17) Note: Same settings as the Alarm 1 Type. However, the LBA (loop burnout alarm) cannot be set.	

Variable type	Address	Parameter name	Setting (monitor) value	Level
C3 (83)	0010	Communications Unit No.* ¹	H'00000000 to H'00000063 (0 to 99)	Commu nications setting
C3 (83)	0011	Communications Baud Rate * ¹	H'00000003 (3): 9.6 H'00000004 (4): 19.2 H'00000005 (5): 38.4 H'00000006 (6): 57.6	
C3 (83)	0012	Communications Data Length * ¹	H'00000007 (7): 7 H'00000008 (8): 8	
C3 (83)	0013	Communications Stop Bits* ¹	H'00000001 (1): 1 H'00000002 (2): 2	
C3 (83)	0014	Communications Parity * ¹	H'00000000 (0): None H'00000001 (1): Even H'00000002 (2): Odd	

*¹ After communications parameters have been changed, reset the Digital Controller to enable them.

Note: The alarm function can also be used in Digital Controllers without auxiliary output terminals. In this case, confirm alarm occurrences via the status data.

Variable type	Address	Parameter name	Setting (monitor) value	Level
C3 (83)	0016	Event Input Assignment 1 ^{*2}	H'00000000 (0): None H'00000001 (1): RUN (OFF)/RESET (ON) H'00000002 (2): RUN (ON)/RESET (OFF) H'00000003 (3): Auto/manual switch H'00000004 (4): RESET H'00000005 (5): RUN H'00000006 (6): Hold/clear hold H'00000007 (7): Hold H'00000008 (8): Advance H'00000009 (9): Program No. switch 0 H'0000000A (10): Program No. switch 1 H'0000000B (11): Program No. switch 2 H'0000000C (12): Direct/reverse operation H'0000000D (13): Program SP mode/fixed SP mode H'0000000E (14): 100% AT execute/cancel H'0000000F (15): 40% AT execute/cancel H'00000010 (16): All PID 100% AT execute/cancel H'00000011 (17): All PID 40% AT execute/cancel H'00000012 (18): Setting Change Enable/Disable H'00000013 (19): Communications Writing Enable/Disable ^{*1} H'00000014 (20): Alarm latch cancel H'00000015 (21): Wait enable (ON)/Disable (OFF)	Initial setting
C3 (83)	0017	Event Input Assignment 2 ^{*2}	H'00000000 to H'00000015 (0 to 21) Note: Same as for Event Input Assignment 1.	
C3 (83)	0018	Event Input Assignment 3 ^{*2}	H'00000000 to H'00000015 (0 to 21) Note: Same as for Event Input Assignment 1.	
C3 (83)	0019	Event Input Assignment 4 ^{*2}	H'00000000 to H'00000015 (0 to 21) Note: Same as for Event Input Assignment 1.	
C3 (83)	001D	Standby Sequence Reset	H'00000000 (0): Condition A H'00000001 (1): Condition B	Advanced function setting
C3 (83)	001E	Auxiliary Output 1 Open in Alarm	H'00000000 (0): Close in alarm H'00000001 (1): Open in alarm	
C3 (83)	001F	Alarm 1 Hysteresis	H'00000001 to H'0000270F (0.1 to 999.9 for temperature input) (0.01 to 99.99 for analog input)	Initial setting
C3 (83)	0020	Auxiliary Output 2 Open in Alarm	H'00000000 (0): Close in alarm H'00000001 (1): Open in alarm	Advanced function setting
C3 (83)	0021	Alarm 2 Hysteresis	H'00000001 to H'0000270F (0.1 to 999.9 for temperature input) (0.01 to 99.99 for analog input)	Initial setting
C3 (83)	0022	Auxiliary Output 3 Open in Alarm	H'00000000 (0): Close in alarm H'00000001 (1): Open in alarm	Advanced function setting
C3 (83)	0023	Alarm 3 Hysteresis	H'00000001 to H'0000270F (0.1 to 999.9 for temperature input) (0.01 to 99.99 for analog input)	Initial setting

Note: The alarm function can also be used in Digital Controllers without auxiliary output terminals. In this case, confirm alarm occurrences via the status data.

*1 Valid only with external communications.

*2 Do not set the same set value for more than one event input assignment.

Variable type	Address	Parameter name	Setting (monitor) value	Level
C3 (83)	0024	HB ON/OFF	H'00000000 (0): OFF H'00000001 (1): ON	Advanced function setting
C3 (83)	0025	Heater Burnout Latch	H'00000000 (0): OFF H'00000001 (1): ON	
C3 (83)	0026	Heater Burnout Hysteresis	H'00000001 to H'000001F4 (0.1 to 50.0)	
C3 (83)	0028	α	H'00000000 to H'00000064 (0.00 to 1.00)	
C3 (83)	002B	Input Digital Filter	H'00000000 to H'0000270F (0.0 to 999.9)	
C3 (83)	002C	PV/SP No. 2 Display Selection	H'00000000 (0): Nothing displayed. H'00000001 (1): PV/SP H'00000002 (2): PV H'00000003 (3): SP/SP (character display)/Nothing displayed H'00000004 (4): PV/SP/MV (heating) (valve opening for Position-proportional Models) H'00000005 (5): PV/SP/MV (cooling) H'00000006 (6): PV/SP/Program No. or segment No. H'00000007 (7): PV/SP/Remaining segment time	
C3 (83)	002E	Automatic Display Return Time	H'00000000 (0): OFF H'00000001 to H'00000063 (1 to 99)	
C3 (83)	002F	Alarm 1 Latch	H'00000000 (0): OFF H'00000001 (1): ON	
C3 (83)	0030	Alarm 2 Latch	H'00000000 (0): OFF H'00000001 (1): ON	
C3 (83)	0031	Alarm 3 Latch	H'00000000 (0): OFF H'00000001 (1): ON	
C3 (83)	0032	Move to Protect Level Time	H'00000001 to H'0000001E (1 to 30)	
C3 (83)	0033	Integrated Alarm Assignment	H'00000000 to H'000000FF (0 to 255)	
C3 (83)	0034	Cold Junction Compensation Method	H'00000000 (0): OFF H'00000001 (1): ON	
C3 (83)	0038	Alarm 1 ON Delay	H'00000000 to H'000003E7 (0 to 999)	
C3 (83)	0039	Alarm 2 ON Delay	H'00000000 to H'000003E7 (0 to 999)	
C3 (83)	003A	Alarm 3 ON Delay	H'00000000 to H'000003E7 (0 to 999)	
C3 (83)	003B	Alarm 1 OFF Delay	H'00000000 to H'000003E7 (0 to 999)	
C3 (83)	003C	Alarm 2 OFF Delay	H'00000000 to H'000003E7 (0 to 999)	
C3 (83)	003D	Alarm 3 OFF Delay	H'00000000 to H'000003E7 (0 to 999)	

Note: The alarm function can also be used in Digital Controllers without auxiliary output terminals. In this case, confirm alarm occurrences via the status data.

Variable type	Address	Parameter name	Setting (monitor) value	Level
C3 (83)	003E	Transfer Output Type	H'00000000 (0): OFF H'00000001 (1): Present SP H'00000002 (2): PV H'00000003 (3): MV (heating) (Disabled for Position-proportional Models.) H'00000004 (4): MV (cooling) (for heating/cooling only) H'00000005 (5): Valve opening * Only for Position-proportional Models.	Initial setting
C3 (83)	003F	Transfer Output Upper Limit	H'FFFFFF831 to H'0000270F (-1999 to 9999) ^{*1}	
C3 (83)	0040	Transfer Output Lower Limit	H'FFFFFF831 to H'0000270F (-1999 to 9999) ^{*1}	
C3 (83)	0041	Control Output 1 Signal	H'00000000 (0): 4 to 20 mA H'00000001 (1): 0 to 20 mA	Advanced function setting
C3 (83)	0045	RT	H'00000000 (0): OFF H'00000001 (1): ON Note: Valid only with temperature input.	
C3 (83)	0046	HS Alarm Use	H'00000000 (0): OFF H'00000001 (1): ON	
C3 (83)	0047	HS Alarm Latch	H'00000000 (0): OFF H'00000001 (1): ON	
C3 (83)	0048	HS Alarm Hysteresis	H'00000001 to H'000001F4 (0.1 to 50.0)	
C3 (83)	0049	LBA Detection Time	H'00000000 to H'0000270F (0 to 9999)	
C3 (83)	004A	LBA Level	H'00000001 to H'0000270F (0.1 to 999.9 for temperature input) (0.01 to 99.99 for analog input)	
C3 (83)	004B	LBA Band	H'00000000 to H'0000270F (0.0 to 999.9 for temperature input) (0.00 to 99.99 for analog input)	

*1 The setting (monitor) range depends on the transfer output type setting. (Refer to *Section 5 Parameters* in the *E5□C-T Digital Temperature Controllers User's Manual* (Cat. No. H185).)

Variable type	Address	Parameter name	Setting (monitor) value	Level
C3 (83)	004C	Protocol Setting ^{*1}	H'00000000 (0): CompoWay/F H'00000001 (1): Modbus H'00000002 (2): Component communications H'00000003 (3): Host Link (FINS) H'00000004 (4): MC protocol (Format 4)	Communications setting
C3 (83)	004D	Send Data Wait Time ^{*1}	H'00000000 to H'00000063 (0 to 99)	
C3 (83)	004E	Control Output 1 Assignment	Control output 1 is a relay output or voltage output (for driving SSR): H'00000000 (0): Not assigned. H'00000001 (1): Control output (heating) H'00000002 (2): Control output (cooling) H'00000003 (3): Alarm 1 H'00000004 (4): Alarm 2 H'00000005 (5): Alarm 3 H'00000006 (6): Alarm 4 H'00000007 (7): Heater alarm H'00000008 (8): HB alarm H'00000009 (9): HS alarm H'0000000A (10): Input error H'0000000B (11): Program end output H'0000000C (12): Stage output H'0000000D (13): RUN output H'0000000E (14): Time signal 1 output H'0000000F (15): Time signal 2 output H'00000010 (16): Integrated alarm H'00000011 (17): Work bit 1 H'00000012 (18): Work bit 2 H'00000013 (19): Work bit 3 H'00000014 (20): Work bit 4 H'00000015 (21): Work bit 5 H'00000016 (22): Work bit 6 H'00000017 (23): Work bit 7 H'00000018 (24): Work bit 8 When control output 1 is a linear current output: H'00000000 (0): Not assigned. H'00000001 (1): Control output (heating) H'00000002 (2): Control output (cooling)	Advanced function setting
C3 (83)	004F	Control Output 2 Assignment	Control output 2 is a relay output or voltage output (for driving SSR): H'00000000 to H'00000018 (0 to 24) * Same as for the Control Output 1 Assignment parameter. When control output 2 is a linear current output: H'00000000 to H'00000002 (0 to 2) * Same as for the Control Output 1 Assignment parameter.	

*1 After communications parameters have been changed, reset the Digital Controller to enable them.

Variable type	Address	Parameter name	Setting (monitor) value	Level
C3 (83)	0050	Auxiliary Output 1 Assignment	H'00000000 (0): Not assigned. H'00000001 (1): Control output (heating) H'00000002 (2): Control output (cooling) H'00000003 (3): Alarm 1 H'00000004 (4): Alarm 2 H'00000005 (5): Alarm 3 H'00000006 (6): Alarm 4 H'00000007 (7): Heater alarm H'00000008 (8): HB alarm H'00000009 (9): HS alarm H'0000000A (10): Input error H'0000000B (11): Program end output H'0000000C (12): Stage output H'0000000D (13): RUN output H'0000000E (14): Time signal 1 output H'0000000F (15): Time signal 2 output H'00000010 (16): Integrated alarm H'00000011 (17): Work bit 1 H'00000012 (18): Work bit 2 H'00000013 (19): Work bit 3 H'00000014 (20): Work bit 4 H'00000015 (21): Work bit 5 H'00000016 (22): Work bit 6 H'00000017 (23): Work bit 7 H'00000018 (24): Work bit 8	Advanced function setting
C3 (83)	0051	Auxiliary Output 2 Assignment	H'00000000 to H'00000018 (0 to 24) Note: Same as for the Auxiliary Output 1 Assignment parameter.	
C3 (83)	0055	Alarm SP Selection	H'00000000 (0): Set point during SP ramp H'00000001 (1): Set point	Advanced function setting
C3 (83)	0056	Auxiliary Output 3 Assignment	H'00000000 to H'00000016 (0 to 22) Note: Same as for the Auxiliary Output 1 Assignment parameter.	
C3 (83)	0057	Close/Floating	H'00000000 (0): Floating H'00000001 (1): Close	Initial setting
C3 (83)	0058	Travel Time	H'00000001 to H'0000003E7 (1 to 999)	
C3 (83)	0059	PV Dead Band	H'00000000 to H'0000270F (0 to 9999)	Advanced function setting
C3 (83)	005B	Manual MV Limit Enable	H'00000000 (0): OFF H'00000001 (1): ON	
C3 (83)	005C	Direct Setting of Position Proportional MV	H'00000000 (0): OFF H'00000001 (1): ON	
C3 (83)	005D	AT Calculated Gain	H'00000001 to H'00000064 (0.1 to 10.0)	
C3 (83)	005E	AT Hysteresis	H'00000001 to H'0000270F (0.1 to 999.9 for temperature input) (0.01 to 9.99 for analog input)	
C3 (83)	005F	Limit Cycle MV Amplitude	H'00000032 to H'000001F4 (5.0 to 50.0)	
C3 (83)	0063	SP Tracking	H'00000000 (0): OFF H'00000001 (1): ON	
C3 (83)	0065	PID Set Automatic Selection Data	H'00000000 (0): PV H'00000001 (1): DV H'00000002 (2): SP	

Variable type	Address	Parameter name	Setting (monitor) value	Level
C3 (83)	0066	PID Set Automatic Selection Hysteresis	H'0000000A to H'0000270F (0.10 to 99.99)	Advanced function setting
C3 (83)	0067	PV Rate of Change Calculation Period	H'00000001 to H'000003E7 (1 to 999)	
C3 (83)	0068	Heating/Cooling Tuning Method	H'00000000 (0): Same (Same as for heating.) H'00000001 (1): Linear H'00000002 (2): Air cooling H'00000003 (3): Water cooling	
C3 (83)	006C	Extraction of Square Root Enable	H'00000000 (0): OFF H'00000001 (1): ON	
C3 (83)	006D	PF Setting	H'00000000 (0): Disabled. H'00000001 (1): Run H'00000002 (2): RESET H'00000003 (3): RUN/RESET H'00000004 (4): Hold/clear hold H'00000005 (5): Advance H'00000006 (6): 100% AT execute/cancel H'00000007 (7): 40% AT execute/cancel H'00000008 (8): All PID 100% AT execute/cancel H'00000009 (9): All PID 40% AT execute/cancel H'0000000A (10): Alarm latch cancel H'0000000B (11): Auto/manual switch H'0000000C (12): Monitor/setting item H'0000000D (13): Digit shift key	
C3 (83)	006E	Monitor/Setting Item 1	H'00000000 (0): Disabled H'00000001 (1): PV/SP/Program No. monitor or segment No. monitor H'00000002 (2): PV/SP/MV (heating) (valve opening for Position-proportional Models) H'00000003 (3): PV/SP/MV (cooling) H'00000004 (4): PV/SP/Remaining segment time H'00000005 (5): Program No. H'00000006 (6): Segment No. monitor H'00000007 (7): Remaining standby time monitor H'00000008 (8): Elapsed program time monitor H'00000009 (9): Remaining program time monitor H'0000000A (10): Elapsed segment time monitor H'0000000B (11): Remaining segment time monitor H'0000000C (12): Program execution repetitions monitor H'0000000D (13): Proportional band H'0000000E (14): Integral time H'0000000F (15): Derivative time H'00000010 (16): Proportional band (cooling) H'00000011 (17): Integral time (cooling) H'00000012 (18): Derivative time (cooling) H'00000013 (19): Alarm value 1 H'00000014 (20): Alarm value upper limit 1 H'00000015 (21): Alarm value lower limit 1 H'00000016 (22): Alarm value 2 H'00000017 (23): Alarm value upper limit 2 H'00000018 (24): Alarm value lower limit 2 H'00000019 (25): Alarm value 3 H'0000001A (26): Alarm value upper limit 3 H'0000001B (27): Alarm value lower limit 3 H'0000001C (28): Alarm value 4 H'0000001D (29): Alarm value upper limit 4 H'0000001E (30): Alarm value lower limit 4	

Variable type	Address	Parameter name	Setting (monitor) value	Level
C3 (83)	006F	Monitor/Setting Item 2	H'00000000 to H'0000001E (0 to 30) Note: Same as for Monitor/Setting Item 1.	Advanced function setting
C3 (83)	0070	Monitor/Setting Item 3	H'00000000 to H'0000001E (0 to 30) Note: Same as for Monitor/Setting Item 1.	
C3 (83)	0071	Monitor/Setting Item 4	H'00000000 to H'0000001E (0 to 30) Note: Same as for Monitor/Setting Item 1.	
C3 (83)	0072	Monitor/Setting Item 5	H'00000000 to H'0000001E (0 to 30) Note: Same as for Monitor/Setting Item 1.	
C3 (83)	0073	PV/SP No. 1 Display Selection	H'00000000 (0): Nothing displayed. H'00000001 (1): PV/SP H'00000002 (2): PV H'00000003 (3): SP/SP (character display)/Nothing displayed H'00000004 (4): PV/SP/MV (heating) (valve opening for Position-proportional Models) H'00000005 (5): PV/SP/MV (cooling) H'00000006 (6): PV/SP/Program No. or segment No. H'00000007 (7): PV/SP/Remaining segment time	
C3 (83)	0076	PV Status Display Function	H'00000000 (0): OFF H'00000001 (1): Manual H'00000002 (2): RESET H'00000003 (3): Alarm 1 H'00000004 (4): Alarm 2 H'00000005 (5): Alarm 3 H'00000006 (6): Alarm 4 H'00000007 (7): Alarm 1 to 4 OR status H'00000008 (8): Heater alarm H'00000009 (9): Standby	
C3 (83)	0077	SV Status Display Function	H'00000000 to H'00000009 (0 to 9) Note: Same as for PV Status Display Function	
C3 (83)	0083	Display Refresh Period	H'00000000 (0): OFF H'00000001 (1): 0.25 H'00000002 (2): 0.5 H'00000003 (3): 1.0	
C3 (83)	0084	Alarm 4 Type	H'00000000 to H'00000011 (0 to 17) Note: Same settings as the Alarm 1 Type. However, the LBA (loop burnout alarm) cannot be set.	Initial setting
C3 (83)	0085	Event Input Assignment 5	H'00000000 to H'00000015 (0 to 21) Note: Same as for Event Input Assignment 1.	
C3 (83)	0086	Event Input Assignment 6	H'00000000 to H'00000015 (0 to 21) Note: Same as for Event Input Assignment 1.	
C3 (83)	0087	Auxiliary Output 4 Open in Alarm	H'00000000 (0): Close in alarm H'00000001 (1): Open in alarm	Advanced function setting
C3 (83)	0088	Alarm 4 Hysteresis	H'00000001 to H'0000270F (0.1 to 999.9 for temperature input) (0.01 to 99.99 for analog input)	Initial setting

Variable type	Address	Parameter name	Setting (monitor) value	Level
C3 (83)	0089	Moving Average Count	H'00000000 (0): OFF H'00000001 (1): 2 times H'00000002 (2): 4 times H'00000003 (3): 8 times H'00000004 (4): 16 times H'00000005 (5): 32 times	Advanced function setting
C3 (83)	008A	Alarm 4 Latch	H'00000000 (0): OFF H'00000001 (1): ON	
C3 (83)	008B	Alarm 4 ON delay	H'00000000 to H'000003E7 (0 to 999)	
C3 (83)	008C	Alarm 4 OFF delay	H'00000000 to H'000003E7 (0 to 999)	
C3 (83)	008D	Control Output 2 Signal	H'00000000 (0): 4 to 20 mA H'00000001 (1): 0 to 20 mA	Initial setting
C3 (83)	008E	Transfer Output Signal	H'00000000 (0): 4 to 20 mA H'00000001 (1): 1 to 5 V	
C3 (83)	008F	Auxiliary Output 4 Assignment	H'00000000 to H'00000018 (0 to 24) Note: Same as for the Auxiliary Output 1 Assignment parameter.	Advanced function setting
C3 (83)	0091	Integral/Derivative Time Unit	H'00000000 (0): 1 s H'00000001 (1): 0.1 s	
C3 (83)	0092	Manual Output Method	H'00000000 (0): HOLD H'00000001 (1): INIT	
C3 (83)	0093	Manual MV Initial Value	Standard control or close position-proportional control: H'FFFFFFCE to H'0000041A (-5.0 to 105.0) Heating and cooling control: H'FFFFFFBE6 to H'0000041A (-105.0 to 105.0)	
C3 (83)	0094	Minimum Output ON/OFF Band	H'00000000 to H'000001F4 (0.0 to 50.0)	
C3 (83)	0095	Display Brightness	H'00000001 to H'00000003 (1 to 3)	
C3 (83)	0096	Highest Communications Unit No.	H'00000000 to H'00000063 (0 to 99)	

Variable type	Address	Parameter name	Setting (monitor) value	Level
C3 (83)	0097	Area	H'00000000 (0: DM or D data registers) H'00000001 (1: EM0 or W link registers) H'00000002 (2: EM1 or R file registers) H'00000003 (3: EM2 or ZR file registers) H'00000004 (4: EM3) H'00000005 (5: EM4) H'00000006 (6: EM5) H'00000007 (7: EM6) H'00000008 (8: EM7) H'00000009 (9: EM8) H'0000000A (10: EM9) H'0000000B (11: EMA) H'0000000C (12: EMB) H'0000000D (13: EMC) H'0000000E (14: EMD) H'0000000F (15: EME) H'00000010 (16: EMF) H'00000011 (17: EM10) H'00000012 (18: EM11) H'00000013 (19: EM12) H'00000014 (20: EM13) H'00000015 (21: EM14) H'00000016 (22: EM15) H'00000017 (23: EM16) H'00000018 (24: EM17) H'00000019 (25: EM18) * Information after "or" is applicable when the Protocol Setting parameter is set to MCP4.) Also, all set values of 4 and higher specify D data registers.	Communications setting
C3 (83)	0098	First Address Upper Word	H'00000000 to H'00000063 (0 to 99)	
C3 (83)	0099	First Address Lower Word	H'00000000 to H'0000270F (0 to 9999)	
C3 (83)	009A	Receive Data Wait Time	H'00000064 to H'0000270F (100 to 9999)	
C3 (83)	009B	Communications Node Number	H'00000000 to H'00000063 (0 to 99)	
C3 (83)	009C	Upload Setting 1	H'00000000 to H'000000B3 (0 to 179)	
C3 (83)	009D	Upload Setting 2	H'00000000 to H'000000B3 (0 to 179)	
C3 (83)	009E	Upload Setting 3	H'00000000 to H'000000B3 (0 to 179)	
C3 (83)	009F	Upload Setting 4	H'00000000 to H'000000B3 (0 to 179)	
C3 (83)	00A0	Upload Setting 5	H'00000000 to H'000000B3 (0 to 179)	
C3 (83)	00A1	Upload Setting 6	H'00000000 to H'000000B3 (0 to 179)	
C3 (83)	00A2	Upload Setting 7	H'00000000 to H'000000B3 (0 to 179)	
C3 (83)	00A3	Upload Setting 8	H'00000000 to H'000000B3 (0 to 179)	
C3 (83)	00A4	Upload Setting 9	H'00000000 to H'000000B3 (0 to 179)	
C3 (83)	00A5	Upload Setting 10	H'00000000 to H'000000B3 (0 to 179)	
C3 (83)	00A6	Upload Setting 11	H'00000000 to H'000000B3 (0 to 179)	
C3 (83)	00A7	Upload Setting 12	H'00000000 to H'000000B3 (0 to 179)	
C3 (83)	00A8	Upload Setting 13	H'00000000 to H'000000B3 (0 to 179)	
C3 (83)	00A9	Download Setting 1	H'0000001E to H'000000B3 (30 to 179)	
C3 (83)	00AA	Download Setting 2	H'0000001E to H'000000B3 (30 to 179)	
C3 (83)	00AB	Download Setting 3	H'0000001E to H'000000B3 (30 to 179)	

Variable type	Address	Parameter name	Setting (monitor) value	Level	
C3 (83)	00AC	Download Setting 4	H'0000001E to H'000000B3 (30 to 179)	Communications setting	
C3 (83)	00AD	Download Setting 5	H'0000001E to H'000000B3 (30 to 179)		
C3 (83)	00AE	Download Setting 6	H'0000001E to H'000000B3 (30 to 179)		
C3 (83)	00AF	Download Setting 7	H'0000001E to H'000000B3 (30 to 179)		
C3 (83)	00B0	Download Setting 8	H'0000001E to H'000000B3 (30 to 179)		
C3 (83)	00B1	Download Setting 9	H'0000001E to H'000000B3 (30 to 179)		
C3 (83)	00B2	Download Setting 10	H'0000001E to H'000000B3 (30 to 179)		
C3 (83)	00B3	Download Setting 11	H'0000001E to H'000000B3 (30 to 179)		
C3 (83)	00B4	Download Setting 12	H'0000001E to H'000000B3 (30 to 179)		
C3 (83)	00B5	Download Setting 13	H'0000001E to H'000000B3 (30 to 179)		
C3 (83)	00B8	LCT Cooling Output Minimum ON Time	H'00000001 to H'0000000A (0.1 to 1.0)		Advanced function setting
C3 (83)	00B9	Program Time Unit	H'00000000 (0): Hours, minutes H'00000001 (1): Minutes, seconds		Initial setting
C3 (83)	00BA	Step Time/Rate of Rise Programming	H'00000000 (0): Step time programming H'00000001 (1): Rate of rise programming		
C3 (83)	00BB	Time Unit of Ramp Rate	H'00000000 (0): Minutes H'00000001 (1): Hours		
C3 (83)	00BC	Reset Operation	H'00000000 (0): Stop control H'00000001 (1): Fixed SP operation		
C3 (83)	00BD	Startup Operation	H'00000000 (0): Continue control at final SP H'00000001 (1): RESET H'00000002 (2): RUN H'00000003 (3): Manual* ¹		
C3 (83)	00BE	Operation End Operation	H'00000000 (0): RESET H'00000001 (1): Continue control at final SP H'00000002 (2): Fixed SP mode* ²		
C3 (83)	00BF	PV Start	H'00000000 (0): SP start H'00000001 (1): PV Start		
C3 (83)	00C0	Program End ON Time	H'00000000 to H'00000064 (0.0 to 10.0) H'FFFFFFF (ON)		
C3 (83)	00C1	Standby Time Unit	H'00000000 (0): Hours, minutes H'00000001 (1): Days, hours	Advanced function setting	
C3 (83)	00C4	Valve Completely Closed Position	H'00000000 to H'0000270F (0 to 9999)	Initial setting	
C3 (83)	00C5	Valve Completely Open Position	H'00000000 to H'0000270F (0 to 9999)		
C3 (83)	00C6	Potentiometer Specification Setting	H'00000000 to H'00000005 (0 to 5)		
C3 (83)	00C8	All PID AT Upper Limit SP	SP lower limit to SP upper limit		

Variable type	Address	Parameter name	Setting (monitor) value	Level
C3 (83)	00C9	Burnout Method	H'00000000 (0): Upscale H'00000001 (1): Downscale	Advanced function setting

*1 Selection is not possible when ON/OFF control is set.

*2 Selection is not possible if the Reset Operation parameter is set to fixed SP operation.

Variable type	Address	Parameter name	Setting (monitor) value	Level
C4 (84)	0000	Program Selection	H'00000000 to H'00000007 (0 to 7)	Program setting
C4 (84)	0001	Number of Segments Used ^{*1}	H'00000001 to H'00000020 (32)	
C4 (84)	0002	Segment Selection ^{*1}	H'00000000 to H'0000001F (31)	
C4 (84)	0003	Segment Format ^{*2}	H'00000000 (0): Ramp H'00000001 (1): Soak H'00000002 (2): Step	
C4 (84)	0004	Segment SP ^{*2}	SP Lower Limit to SP Upper Limit	
C4 (84)	0005	Segment Slope ^{*2}	H'00000000 to H'0000270F (0 to 9999)	
C4 (84)	0006	Segment Time ^{*2}	H'00000000 to H'00009959 (0.00 to 99.59) (hours, minutes) H'00000000 to H'00009959 (0.00 to 99.59) (minutes, seconds)	
C4 (84)	0007	PID Set No. ^{*1}	H'00000000 to H'00000008 (0 to 8), (0): Automatic selection	
C4 (84)	0008	Alarm Value 1 ^{*1}	H'FFFFFF831 to H'0000270F (-1999 to 9999)	
C4 (84)	0009	Alarm Value Upper Limit 1 ^{*1}	H'FFFFFF831 to H'0000270F (-1999 to 9999)	
C4 (84)	000A	Alarm Value Lower Limit 1 ^{*1}	H'FFFFFF831 to H'0000270F (-1999 to 9999)	
C4 (84)	000B	Alarm Value 2 ^{*1}	H'FFFFFF831 to H'0000270F (-1999 to 9999)	
C4 (84)	000C	Alarm Value Upper Limit 2 ^{*1}	H'FFFFFF831 to H'0000270F (-1999 to 9999)	
C4 (84)	000D	Alarm Value Lower Limit 2 ^{*1}	H'FFFFFF831 to H'0000270F (-1999 to 9999)	
C4 (84)	000E	Alarm Value 3 ^{*1}	H'FFFFFF831 to H'0000270F (-1999 to 9999)	
C4 (84)	000F	Alarm Value Upper Limit 3 ^{*1}	H'FFFFFF831 to H'0000270F (-1999 to 9999)	
C4 (84)	0010	Alarm Value Lower Limit 3 ^{*1}	H'FFFFFF831 to H'0000270F (-1999 to 9999)	
C4 (84)	0011	Alarm Value 4 ^{*1}	H'FFFFFF831 to H'0000270F (-1999 to 9999)	
C4 (84)	0012	Alarm Value Upper Limit 4 ^{*1}	H'FFFFFF831 to H'0000270F (-1999 to 9999)	
C4 (84)	0013	Alarm Value Lower Limit 4 ^{*1}	H'FFFFFF831 to H'0000270F (-1999 to 9999)	

*1 The set values for the program specified in the Program Selection parameter are accessed for the following parameters: No. of Segments Used, Segment Selection, PID Set No., Alarm Values 1 to 4, Alarm Upper Limits 1 to 4, Alarm Lower Limits 1 to 4, Program Repetitions, Program Link Destination No., Time Signal 1 and 2 Set Segments, Time Signal 1 and 2 ON Times, and Time Signal 1 and 2 OFF Times. Check the set value of the Program Selection parameter before accessing these parameters.

*2 The set values for the program specified in the Program Selection parameter and the section specified in the Segment Selection parameter are accessed for the following parameters: Segment Type, Segment SP, Segment Slope, and Segment Time. Check the set value of the Program Selection and Segment Selection parameters before accessing these parameters.

Variable type	Address	Parameter name	Setting (monitor) value	Level
C4 (84)	0014	Program Repetitions ^{*1}	H'00000000 to H'0000270F (0 to 9999)	Program setting
C4 (84)	0015	Program Link Destination No. ^{*1}	H'FFFFFFFF (-1): No link H'00000000 to H'00000007 (0 to 7)	
C4 (84)	0016	Time Signal 1 Set Segment ^{*1}	H'00000000 (0) to No. of segments used - 1	
C4 (84)	0017	Time Signal 1 ON Time ^{*1}	H'00000000 to H'00009959 (0.00 to 99.59) (hours, minutes) H'00000000 to H'00009959 (0.00 to 99.59) (minutes, seconds)	
C4 (84)	0018	Time Signal 1 OFF Time ^{*1}	H'00000000 to H'00009959 (0.00 to 99.59) (hours, minutes) H'00000000 to H'00009959 (0.00 to 99.59) (minutes, seconds)	
C4 (84)	0019	Time Signal 2 Set Segment ^{*1}	H'00000000 (0) to No. of segments used - 1	
C4 (84)	001A	Time Signal 2 ON Time ^{*1}	H'00000000 to H'00009959 (0.00 to 99.59) (hours, minutes) H'00000000 to H'00009959 (0.00 to 99.59) (minutes, seconds)	
C4 (84)	001B	Time Signal 2 OFF Time ^{*1}	H'00000000 to H'00009959 (0.00 to 99.59) (hours, minutes) H'00000000 to H'00009959 (0.00 to 99.59) (minutes, seconds)	

*1 The set values for the program specified in the Program Selection parameter are accessed for the following parameters: No. of Segments Used, Segment Selection, PID Set No., Alarm Values 1 to 4, Alarm Upper Limits 1 to 4, Alarm Lower Limits 1 to 4, Program Repetitions, Program Link Destination No., Time Signal 1 and 2 Set Segments, Time Signal 1 and 2 ON Times, and Time Signal 1 and 2 OFF Times. Check the set value of the Program Selection parameter before accessing these parameters.

Variable type	Address	Parameter name	Setting (monitor) value	Level
C5 (85)	0000	PID 1 Proportional Band	H'00000001 to H'0000270F (0.1 to 999.9)	PID Setting
C5 (85)	0001	PID 1 Integral Time	Standard, heating/cooling, or close position-proportional control: H'00000000 to H'0000270F (0 to 9999: Integral/derivative time unit is 1 s.) (0.0 to 999.9: Integral/derivative time unit is 0.1 s.) Floating position-proportional control: H'00000001 to H'0000270F (1 to 9999: Integral/derivative time unit is 1 s.) (0.1 to 999.9: Integral/derivative time unit is 0.1 s.)	
C5 (85)	0002	PID 1 Derivative Time	H'00000000 to H'0000270F (0 to 9999: Integral/derivative time unit is 1 s.) (0.0 to 999.9: Integral/derivative time unit is 0.1 s.)	
C5 (85)	0003	PID 1 MV Upper Limit	Standard control or position proportional (closed): MV lower limit +0.1 to H'0000041A (MV lower limit +0.1 to 105.0) Heating/cooling control: H'00000000 to H'0000041A (0.0 to 105.0)	

Variable type	Address	Parameter name	Setting (monitor) value	Level
C5 (85)	0004	PID 1 MV Lower Limit	Standard control or position proportional (closed): H'FFFFFFCE to MV upper limit –0.1 (–5.0 to MV upper limit –0.1) Heating/cooling control: H'FFFFFFBE6 to H'00000000 (–105.0 to 0.0)	PID Setting
C5 (85)	0005	PID 1 Automatic Selection Range Upper Limit	Temperature input: H'FFFFFF831 to H'0000270F (–1999 to 9999) Analog input: H'FFFFFFCE to H'0000041A (–5.0 to 105.0)	
C5 (85)	0007	PID 1 LBA Detection Time	H'00000000 to H'0000270F (0 to 9999)	
C5 (85)	0008	PID 1 Proportional Band (Cooling)	H'00000001 to H'0000270F (0.1 to 999.9)	
C5 (85)	0009	PID 1 Integral Time (Cooling)	H'00000000 to H'0000270F (0 to 9999: Integral/derivative time unit is 1 s.) (0.0 to 999.9: Integral/derivative time unit is 0.1 s.)	
C5 (85)	000A	PID 1 Derivative Time (Cooling)	H'00000000 to H'0000270F (0 to 9999: Integral/derivative time unit is 1 s.) (0.0 to 999.9: Integral/derivative time unit is 0.1 s.)	
C5 (85)	000B	PID 1 Dead Band	Temperature input: H'FFFFFF831 to H'0000270F (–1999 to 999.9) Analog input: H'FFFFFF831 to H'0000270F (–19.99 to 99.99)	
C5 (85)	000C	PID 1 Manual Reset Value	H'00000000 to H'000003E8 (0.0 to 100.0)	
C5 (85)	0010	PID 2 Proportional Band	H'00000001 to H'0000270F (0.1 to 999.9)	
	to	to		
C5 (85)	001C	PID 2 Manual Reset Value	H'00000000 to H'0000270F (0 to 9999)	
C5 (85)	0020	PID 3 Proportional Band	H'00000001 to H'0000270F (0.1 to 999.9)	
	to	to		
C5 (85)	002C	PID 3 Manual Reset Value	H'00000000 to H'0000270F (0 to 9999)	
C5 (85)	0030	PID 4 Proportional Band	H'00000001 to H'0000270F (0.1 to 999.9)	
	to	to		
C5 (85)	003C	PID 4 Manual Reset Value	H'00000000 to H'0000270F (0 to 9999)	
C5 (85)	0040	PID 5 Proportional Band	H'00000001 to H'0000270F (0.1 to 999.9)	
	to	to		
C5 (85)	004C	PID 5 Manual Reset Value	H'00000000 to H'0000270F (0 to 9999)	
C5 (85)	0050	PID 6 Proportional Band	H'00000001 to H'0000270F (0.1 to 999.9)	
	to	to		
C5 (85)	005C	PID 6 Manual Reset Value	H'00000000 to H'0000270F (0 to 9999)	

Variable type	Address	Parameter name	Setting (monitor) value	Level
C5 (85)	0060	PID 7 Proportional Band	H'00000001 to H'0000270F (0.1 to 999.9)	PID Setting
	to	to		
C5 (85)	006C	PID 7 Manual Reset Value	H'00000000 to H'0000270F (0 to 9999)	
	to	to		
C5 (85)	0070	PID 8 Proportional Band	H'00000001 to H'0000270F (0.1 to 999.9)	PID Setting
	to	to		
C5 (85)	007C	PID 8 Manual Reset Value	H'00000000 to H'0000270F (0 to 9999)	
	to	to		
C9 (89)	0000	Upload Setting 1	H'00000000 to H'000000B3 (0 to 179)	Communications setting
C9 (89)	0001	Upload Setting 2	H'00000000 to H'000000B3 (0 to 179)	
C9 (89)	0002	Upload Setting 3	H'00000000 to H'000000B3 (0 to 179)	
C9 (89)	0003	Upload Setting 4	H'00000000 to H'000000B3 (0 to 179)	
C9 (89)	0004	Upload Setting 5	H'00000000 to H'000000B3 (0 to 179)	
C9 (89)	0005	Upload Setting 6	H'00000000 to H'000000B3 (0 to 179)	
C9 (89)	0006	Upload Setting 7	H'00000000 to H'000000B3 (0 to 179)	
C9 (89)	0007	Upload Setting 8	H'00000000 to H'000000B3 (0 to 179)	
C9 (89)	0008	Upload Setting 9	H'00000000 to H'000000B3 (0 to 179)	
C9 (89)	0009	Upload Setting 10	H'00000000 to H'000000B3 (0 to 179)	
C9 (89)	000A	Upload Setting 11	H'00000000 to H'000000B3 (0 to 179)	
C9 (89)	000B	Upload Setting 12	H'00000000 to H'000000B3 (0 to 179)	
C9 (89)	000C	Upload Setting 13	H'00000000 to H'000000B3 (0 to 179)	
C9 (89)	000D	Upload Setting 14	H'00000000 to H'000000B3 (0 to 179)	
C9 (89)	000E	Upload Setting 15	H'00000000 to H'000000B3 (0 to 179)	
C9 (89)	000F	Upload Setting 16	H'00000000 to H'000000B3 (0 to 179)	
C9 (89)	0010	Upload Setting 17	H'00000000 to H'000000B3 (0 to 179)	
C9 (89)	0011	Upload Setting 18	H'00000000 to H'000000B3 (0 to 179)	
C9 (89)	0012	Upload Setting 19	H'00000000 to H'000000B3 (0 to 179)	
C9 (89)	0013	Upload Setting 20	H'00000000 to H'000000B3 (0 to 179)	
C9 (89)	0014	Upload Setting 21	H'00000000 to H'000000B3 (0 to 179)	
C9 (89)	0015	Upload Setting 22	H'00000000 to H'000000B3 (0 to 179)	
C9 (89)	0016	Upload Setting 23	H'00000000 to H'000000B3 (0 to 179)	
C9 (89)	0017	Download Setting 1	H'0000001E to H'000000B3 (30 to 179)	
C9 (89)	0018	Download Setting 2	H'0000001E to H'000000B3 (30 to 179)	
C9 (89)	0019	Download Setting 3	H'0000001E to H'000000B3 (30 to 179)	
C9 (89)	001A	Download Setting 4	H'0000001E to H'000000B3 (30 to 179)	
C9 (89)	001B	Download Setting 5	H'0000001E to H'000000B3 (30 to 179)	
C9 (89)	001C	Download Setting 6	H'0000001E to H'000000B3 (30 to 179)	
C9 (89)	001D	Download Setting 7	H'0000001E to H'000000B3 (30 to 179)	
C9 (89)	001E	Download Setting 8	H'0000001E to H'000000B3 (30 to 179)	
C9 (89)	001F	Download Setting 9	H'0000001E to H'000000B3 (30 to 179)	
C9 (89)	0020	Download Setting 10	H'0000001E to H'000000B3 (30 to 179)	
C9 (89)	0021	Download Setting 11	H'0000001E to H'000000B3 (30 to 179)	
C9 (89)	0022	Download Setting 12	H'0000001E to H'000000B3 (30 to 179)	
C9 (89)	0023	Download Setting 13	H'0000001E to H'000000B3 (30 to 179)	
C9 (89)	0024	Download Setting 14	H'0000001E to H'000000B3 (30 to 179)	
C9 (89)	0025	Download Setting 15	H'0000001E to H'000000B3 (30 to 179)	
C9 (89)	0026	Download Setting 16	H'0000001E to H'000000B3 (30 to 179)	
C9 (89)	0027	Download Setting 17	H'0000001E to H'000000B3 (30 to 179)	
C9 (89)	0028	Download Setting 18	H'0000001E to H'000000B3 (30 to 179)	
C9 (89)	0029	Download Setting 19	H'0000001E to H'000000B3 (30 to 179)	
C9 (89)	002A	Download Setting 20	H'0000001E to H'000000B3 (30 to 179)	

Variable type	Address	Parameter name	Setting (monitor) value	Level
C9 (89)	002B	Download Setting 21	H'0000001E to H'000000B3 (30 to 179)	Communications setting
C9 (89)	002C	Download Setting 22	H'0000001E to H'000000B3 (30 to 179)	
C9 (89)	002D	Download Setting 23	H'0000001E to H'000000B3 (30 to 179)	
C9 (89)	002E	Download Setting 24	H'0000001E to H'000000B3 (30 to 179)	
C9 (89)	002F	Download Setting 25	H'0000001E to H'000000B3 (30 to 179)	
C9 (89)	0030	Download Setting 26	H'0000001E to H'000000B3 (30 to 179)	
C9 (89)	0031	Download Setting 27	H'0000001E to H'000000B3 (30 to 179)	
C9 (89)	0032	Download Setting 28	H'0000001E to H'000000B3 (30 to 179)	
C9 (89)	0033	Download Setting 29	H'0000001E to H'000000B3 (30 to 179)	
C9 (89)	0034	Download Setting 30	H'0000001E to H'000000B3 (30 to 179)	
C9 (89)	0035	Download Setting 31	H'0000001E to H'000000B3 (30 to 179)	
C9 (89)	0036	Download Setting 32	H'0000001E to H'000000B3 (30 to 179)	
C9 (89)	0037	Download Setting 33	H'0000001E to H'000000B3 (30 to 179)	
C9 (89)	0038	Download Setting 34	H'0000001E to H'000000B3 (30 to 179)	
C9 (89)	0039	Download Setting 35	H'0000001E to H'000000B3 (30 to 179)	
C9 (89)	003A	Download Setting 36	H'0000001E to H'000000B3 (30 to 179)	
C9 (89)	003B	Download Setting 37	H'0000001E to H'000000B3 (30 to 179)	
C9 (89)	003C	Download Setting 38	H'0000001E to H'000000B3 (30 to 179)	
C9 (89)	003D	Download Setting 39	H'0000001E to H'000000B3 (30 to 179)	
C9 (89)	003E	Download Setting 40	H'0000001E to H'000000B3 (30 to 179)	
C9 (89)	003F	Download Setting 41	H'0000001E to H'000000B3 (30 to 179)	
C9 (89)	0040	Download Setting 42	H'0000001E to H'000000B3 (30 to 179)	
C9 (89)	0041	Download Setting 43	H'0000001E to H'000000B3 (30 to 179)	

Variable type	Address	Parameter name	Setting (monitor) value	Level
DA (9A)	0000	Program 0 No. of Segments Used	H'00000001 to H'00000020 (1 to 32)	Program setting
DA (9A)	0001	Program 0 PID Set No.	H'00000000 to H'00000008 (0 to 8), (0): Automatic selection	
DA (9A)	0002	Program 0 Alarm Value 1	H'FFFFFF831 to H'0000270F (-1999 to 9999)	
DA (9A)	0003	Program 0 Alarm Upper Limit 1	H'FFFFFF831 to H'0000270F (-1999 to 9999)	
DA (9A)	0004	Program 0 Alarm Lower Limit 1	H'FFFFFF831 to H'0000270F (-1999 to 9999)	
DA (9A)	0005	Program 0 Alarm Value 2	H'FFFFFF831 to H'0000270F (-1999 to 9999)	
DA (9A)	0006	Program 0 Alarm Upper Limit 2	H'FFFFFF831 to H'0000270F (-1999 to 9999)	
DA (9A)	0007	Program 0 Alarm Lower Limit 2	H'FFFFFF831 to H'0000270F (-1999 to 9999)	
DA (9A)	0008	Program 0 Alarm Value 3	H'FFFFFF831 to H'0000270F (-1999 to 9999)	
DA (9A)	0009	Program 0 Alarm Upper Limit 3	H'FFFFFF831 to H'0000270F (-1999 to 9999)	
DA (9A)	000A	Program 0 Alarm Lower Limit 3	H'FFFFFF831 to H'0000270F (-1999 to 9999)	
DA (9A)	000B	Program 0 Alarm Value 4	H'FFFFFF831 to H'0000270F (-1999 to 9999)	
DA (9A)	000C	Program 0 Alarm Upper Limit 4	H'FFFFFF831 to H'0000270F (-1999 to 9999)	
DA (9A)	000D	Program 0 Alarm Lower Limit 4	H'FFFFFF831 to H'0000270F (-1999 to 9999)	
DA (9A)	000E	Program 0 Program Repetitions	H'00000000 to H'0000270F (0 to 9999)	
DA (9A)	000F	Program 0 Program Link Destination No.	H'FFFFFFFF (-1): No link H'00000000 to H'00000007 (0 to 7)	
DA (9A)	0010	Program 0 Time Signal 1 Set Segment	H'00000000 (0) to No. of segments used - 1	
DA (9A)	0011	Program 0 Time Signal 1 ON Time	H'00000000 to H'00009959 (0.00 to 99.59) (hours, minutes) H'00000000 to H'00009959 (0.00 to 99.59) (minutes, seconds)	
DA (9A)	0012	Program 0 Time Signal 1 OFF Time	H'00000000 to H'00009959 (0.00 to 99.59) (hours, minutes) H'00000000 to H'00009959 (0.00 to 99.59) (minutes, seconds)	
DA (9A)	0013	Program 0 Time Signal 2 Set Segment	H'00000000 (0) to No. of segments used - 1	
DA (9A)	0014	Program 0 Time Signal 2 ON Time	H'00000000 to H'00009959 (0.00 to 99.59) (hours, minutes) H'00000000 to H'00009959 (0.00 to 99.59) (minutes, seconds)	

Variable type	Address	Parameter name	Setting (monitor) value	Level
DA (9A)	0015	Program 0 Time Signal 2 OFF Time	H'00000000 to H'00009959 (0.00 to 99.59) (hours, minutes) H'00000000 to H'00009959 (0.00 to 99.59) (minutes, seconds)	Program setting
DA (9A)	0016	Program 0 Segment 0 Type	H'00000000 (0): Ramp H'00000001 (1): Soak H'00000002 (2): Step	
DA (9A)	0017	Program 0 Segment 0 SP	SP lower limit to SP upper limit	
DA (9A)	0018	Program 0 Segment 0 Slope	H'00000000 to H'0000270F (0 to 9999)	
DA (9A)	0019	Program 0 Segment 0 Time	H'00000000 to H'00009959 (0.00 to 99.59) (hours, minutes) H'00000000 to H'00009959 (0.00 to 99.59) (minutes, seconds)	
DA (9A)	001A	Program 0 Segment 1 Type	Same as for segment 0.	
	to	to		
DA (9A)	001E	Program 0 Segment 2 Type		
	to	to		
DA (9A)	0022	Program 0 Segment 3 Type		
	to	to		
DA (9A)	0026	Program 0 Segment 4 Type		
	to	to		
DA (9A)	002A	Program 0 Segment 5 Type		
	to	to		
DA (9A)	002E	Program 0 Segment 6 Type		
	to	to		
DA (9A)	0032	Program 0 Segment 7 Type		
	to	to		
DA (9A)	0036	Program 0 Segment 8 Type		
	to	to		
DA (9A)	003A	Program 0 Segment 9 Type		
	to	to		
DA (9A)	003E	Program 0 Segment 10 Type		
	to	to		
DA (9A)	0042	Program 0 Segment 11 Type		
	to	to		
DA (9A)	0046	Program 0 Segment 12 Type		
	to	to		
DA (9A)	004A	Program 0 Segment 13 Type		
	to	to		

Variable type	Address	Parameter name	Setting (monitor) value	Level
DA (9A)	004E	Program 0 Segment 14 Type		Program setting
	to	to		
DA (9A)	0052	Program 0 Segment 15 Type		
	to	to		
DA (9A)	0056	Program 0 Segment 16 Type		
	to	to		
DA (9A)	005A	Program 0 Segment 17 Type		
	to	to		
DA (9A)	005E	Program 0 Segment 18 Type		
	to	to		
DA (9A)	0062	Program 0 Segment 19 Type		
	to	to		
DA (9A)	0066	Program 0 Segment 20 Type		
	to	to		
DA (9A)	006A	Program 0 Segment 21 Type		
	to	to		
DA (9A)	006E	Program 0 Segment 22 Type		
	to	to		
DA (9A)	0072	Program 0 Segment 23 Type		
	to	to		
DA (9A)	0076	Program 0 Segment 24 Type		
	to	to		
DA (9A)	007A	Program 0 Segment 25 Type		
	to	to		
DA (9A)	007E	Program 0 Segment 26 Type		
	to	to		
DA (9A)	0082	Program 0 Segment 27 Type		
	to	to		
DA (9A)	0086	Program 0 Segment 28 Type		
	to	to		
DA (9A)	008A	Program 0 Segment 29 Type		
	to	to		
DA (9A)	008E	Program 0 Segment 30 Type		
	to	to		
DA (9A)	0092	Program 0 Segment 31 Type		
	to	to		

Variable type	Address	Parameter name	Setting (monitor) value	Level
DA (9A)	0100	Program 1 No. of Segments Used	Same as for program 0.	Program setting
	to	to		
DA (9A)	0200	Program 2 No. of Segments Used		
	to	to		
DA (9A)	0300	Program 3 No. of Segments Used		
	to	to		
DA (9A)	0400	Program 4 No. of Segments Used		
	to	to		
DA (9A)	0500	Program 5 No. of Segments Used		
	to	to		
DA (9A)	0600	Program 6 No. of Segments Used		
	to	to		
DA (9A)	0700	Program 7 No. of Segments Used		
	to	to		

3-2 Status and Status 2

The figure below shows the structure of the status data.

● **Status Structure**

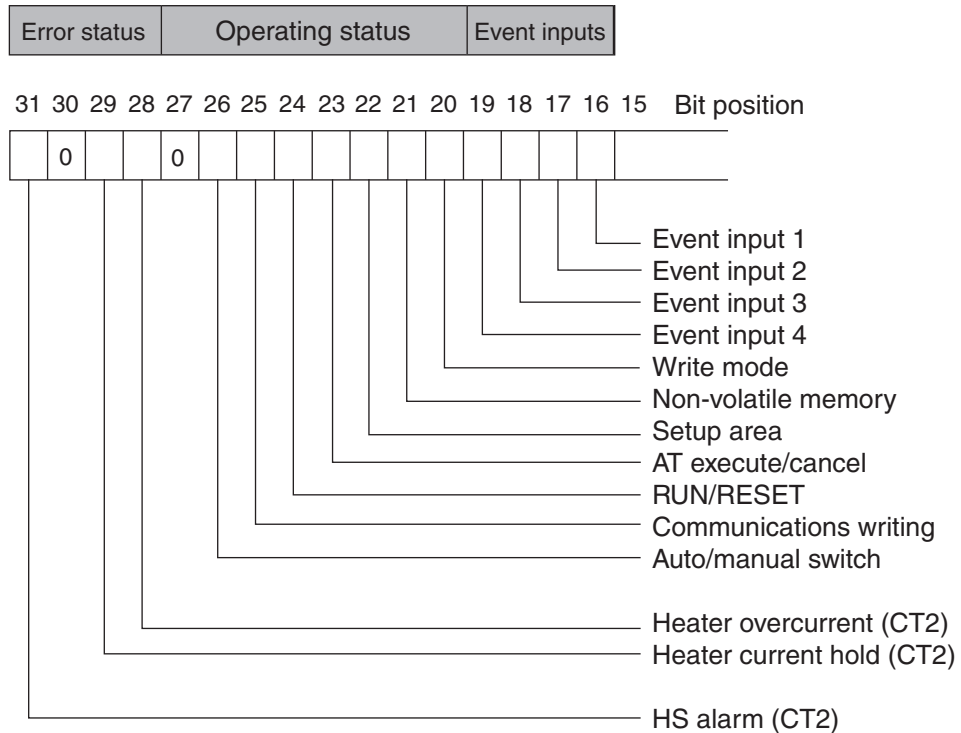
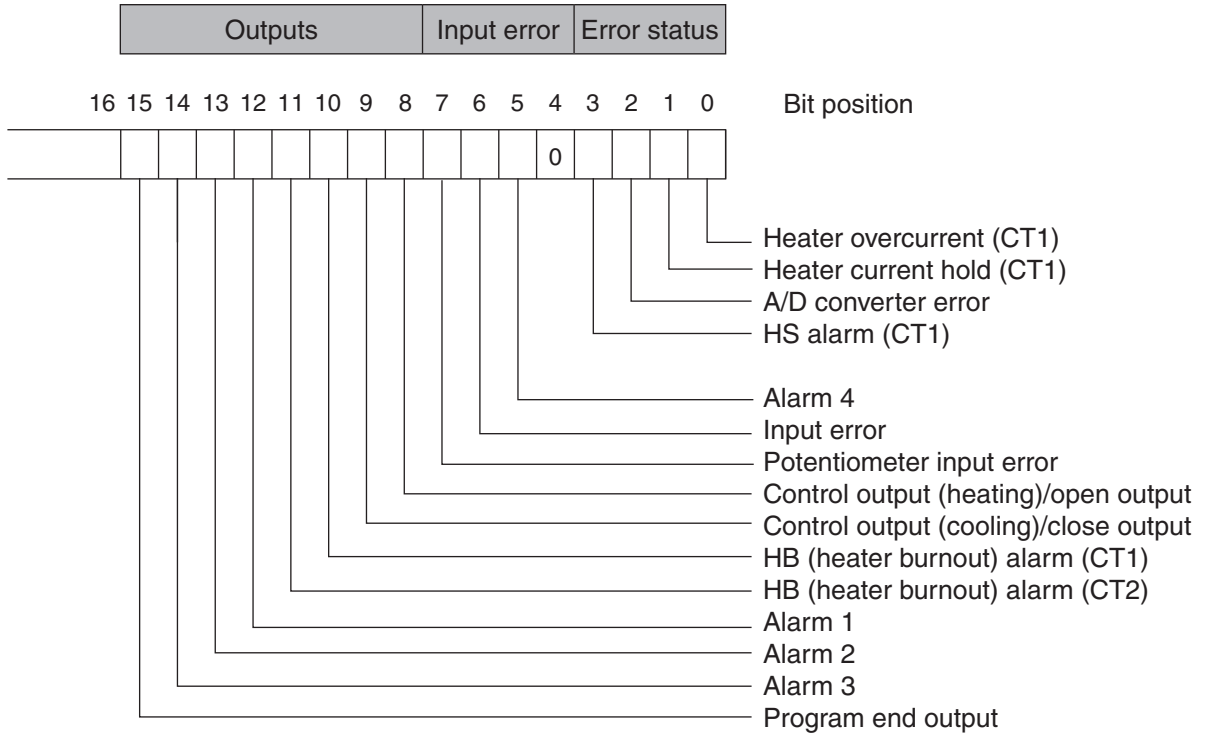

● Status 2 Structure

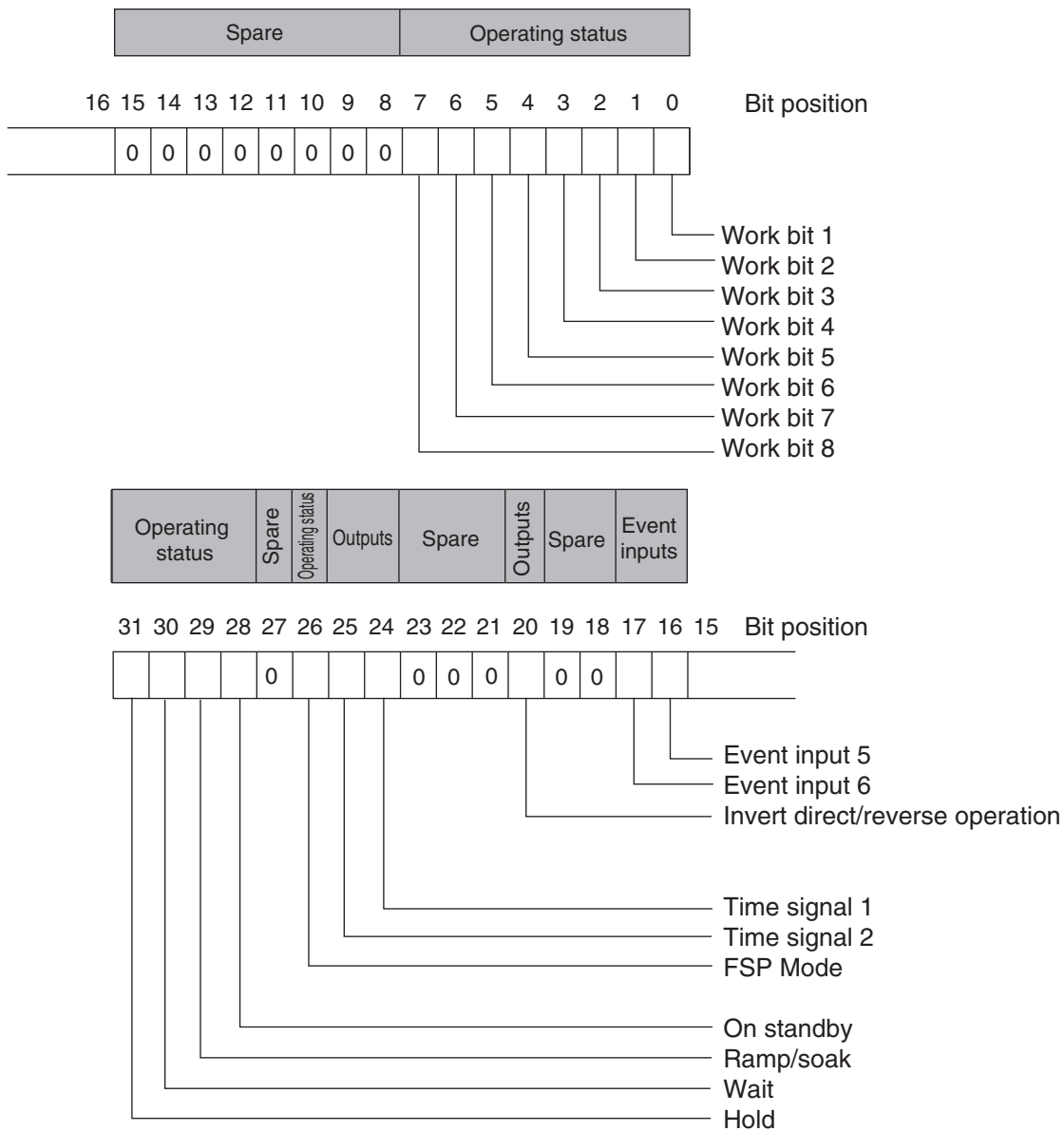

● Status Details

Bit position	Status	Bit Description		
		0	1	
Status (lower word)	0	Heater overcurrent (CT1)	Not generated	Generated
	1	Heater current hold (CT1)*	Update	Hold
	2	A/D converter error	Not generated	Generated
	3	HS alarm (CT1)	OFF	ON
	4	Spare	Not generated	---
	5	Alarm 4	OFF	ON
	6	Input error	Not generated	Generated
	7	Potentiometer input error	Not generated	Generated
	8	Control output (heating)/open output	OFF	ON
	9	Control output (cooling)/close output	OFF	ON
	10	HB (heater burnout) alarm (CT1)	OFF	ON
	11	HB (heater burnout) alarm (CT2)	OFF	ON
	12	Alarm 1	OFF	ON
	13	Alarm 2	OFF	ON
	14	Alarm 3	OFF	ON
Status (upper word)	15	Program end output	OFF	ON
	16	Event input 1	OFF	ON
	17	Event input 2	OFF	ON
	18	Event input 3	OFF	ON
	19	Event input 4	OFF	ON
	20	Write mode	Backup mode	RAM write mode
	21	Non-volatile memory	RAM = Non-volatile memory	RAM ≠ Non-volatile memory
	22	Setup area	Setup area 0	Setup area 1
	23	AT execute/cancel	AT canceled	AT execution in progress
	24	RUN/RESET	Run	Reset
	25	Communications writing	OFF (disabled)	ON (enabled)
	26	Auto/manual switch	Automatic mode	Manual mode
	27	Spare	OFF	---
	28	Heater overcurrent (CT2)	Not generated	Generated
	29	Heater current hold (CT2)	Update	Hold
	30	Spare	OFF	---
	31	HS alarm (CT2)	OFF	ON

Note 1 "Spare" bits are always OFF.

2 When read in setup area 1, the status of the bits will be as follows:

- Overcurrent: Last value held
- A/D converter error: Last value held
- Input error: Last value held
- Potentiometer input error: Last value held
- HB and HS outputs: Cleared
- Program end output: Cleared
- Current hold: Last value held
- Heating and cooling outputs,
open output, close output: Cleared
- Alarm outputs: Cleared

* When the control output ON time is less than 30 ms for a control period of 0.1 s or 0.2 s or when it is less than 100 ms for any other control period, the bit is set to "1" and the heater current is held at the last current value.

● Status 2 Details

Bit position	Status	Bit Description		
		0	1	
Status (lower word)	0	Work bit 1	OFF	ON
	1	Work bit 2	OFF	ON
	2	Work bit 3	OFF	ON
	3	Work bit 4	OFF	ON
	4	Work bit 5	OFF	ON
	5	Work bit 6	OFF	ON
	6	Work bit 7	OFF	ON
	7	Work bit 8	OFF	ON
	8	Spare	OFF	---
	9	Spare	OFF	---
	10	Spare	OFF	---
	11	Spare	OFF	---
	12	Spare	OFF	---
	13	Spare	OFF	---
	14	Spare	OFF	---
Status (upper word)	15	Spare	OFF	---
	16	Event input 5	OFF	ON
	17	Event input 6	OFF	ON
	18	Spare	OFF	---
	19	Spare	OFF	---
	20	Invert direct/reverse operation	Not invert	Invert
	21	Spare	OFF	---
	22	Spare	OFF	---
	23	Spare	OFF	---
	24	Time signal 1	OFF	ON
	25	Time signal 2	OFF	ON
	26	FSP Mode	OFF (PSP)	ON (FSP)
	27	Spare	OFF	---
	28	On standby	OFF	On standby
	29	Ramp/soak	Soak	Ramp
	30	Wait	OFF	Waiting
	31	Hold	OFF	Holding

Note 1 "Spare" bits are always OFF.

2 When read in setup area 1, the status of the bits will be as follows:

- Work bits 1 to 8: Cleared
- Time signals 1 and 2: Last value held
- FSP Mode: Last value held
- On standby: Last value held
- Ramp/soak: Last value held
- Wait: Last value held
- Hold: Last value held

4

Modbus Communications Procedure

Read this section if you are to communicate using the Modbus format.

4

4-1 Data Format	4-2
4-1-1 Command Frame	4-2
4-1-2 Response Frame	4-4
4-1-3 Error Codes	4-5
4-2 Function List	4-6
4-3 Variable Area	4-7
4-4 Detailed Description of the Services	4-8
4-4-1 Variable Read, Multiple	4-8
4-4-2 Variable Write, Multiple	4-10
4-4-3 Variable Write, Single/Operation Command	4-12
4-4-4 Echoback Test	4-14

4-1 Data Format

The data format complies with the Modbus (RTU) communications protocol, so commands from the host and responses from the E5□C-T are contained in data blocks called frames.

The structure of the command and response frames is described below.

In the following explanations, hexadecimal values are expressed by adding the prefix H' before the number, e.g., H'02. Numbers and alphabetic characters without the H' prefix are ASCII characters.

4-1-1 Command Frame

When using RTU mode, start with a silent interval of at least 3.5 character times and end with a silent interval of at least 3.5 character times.

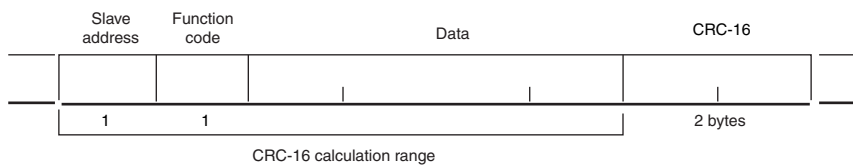

	Silent interval of 3.5 character times minimum.
Slave address	Specify the unit number. The unit number can be set between H'00 to H'63 hexadecimal (0 to 99 decimal). Specify H'00 for a broadcast transmission. No responses will be returned for broadcast transmissions.
Function code	The function code is a 1-byte hexadecimal code that indicates the type of command sent from the host device.
Data	This is the text data associated with the specified function code. Specify the required data, such as the variable address or setting data. (Set in hexadecimal.)
CRC-16	Cyclic Redundancy Check This check code is calculated with the data from the slave address to the end of the data. The check code is 2-byte hexadecimal.
	Silent interval of 3.5 character times minimum.

● **CRC-16 Calculation Example**

Messages are processed one byte at a time in the work memory (a 16-bit register known as the CRC register).

- (1) The CRC register is initialized to H'FFFF.
- (2) An XOR operation is performed on the content of the CRC register and the first byte of the message, and the result is returned to the CRC register.
- (3) The MSB is packed with zeroes and the CRC register is shifted 1 bit to the right.
- (4) If the bit shifted from the LSB is 0, step 3 is repeated (next bit-shift processing).
If the bit shifted from the LSB is 1, an XOR is performed on the content of the CRC register and H'A001, and the result is returned to the CRC register.
- (5) Steps 3 and 4 are repeated until 8 bits are shifted.
- (6) CRC processing continues to the end of the message, as XOR operations are performed on the content of the CRC register and the next byte of the message, step 3 is repeated, and the result is returned to the CRC register.
- (7) The result of the CRC calculation (value in the CRC register) is appended to the last byte of the message.

● **Example of Appending the Calculation Result**

When the calculated CRC value is H'1234, the CRC value is appended to the command frame as follows.

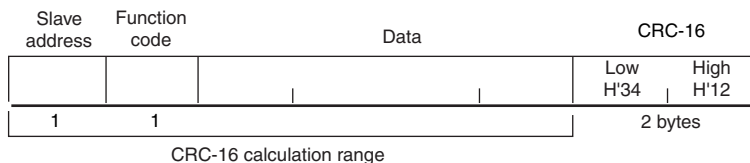

4-1-2 Response Frame

● Normal Response Frame

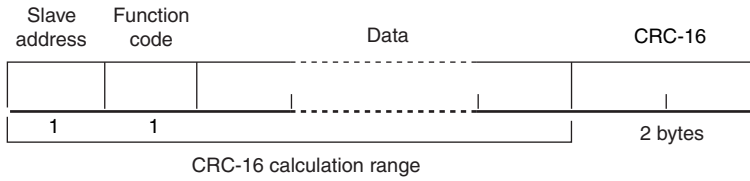

● Error Response Frame

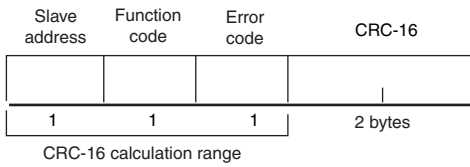

Slave address	The number specified in the command frame is entered as-is. This is the unit number of the Unit returning the response.
Function code	This is the received function code with the hexadecimal value of H'80 added to indicate that the response is an error response. Example: Received function code = H'03 Function code in response frame when an error occurred = H'83
Error code	This code indicates the kind of error that occurred.
CRC-16	Cyclic Redundancy Check This check code is calculated with the data from the slave address to the end of the data. The check code is 2-byte hexadecimal.

4-1-3 Error Codes

End code	Name	Description
H'01	Function code error	An unsupported function code was received.
H'02	Variable address error	The specified variable area address is out-of-range.
H'03	Variable data error	The amount of data does not match the number of elements. The byte count is not 2 times the number of elements. The response length exceeds the size of the communications buffer. The command code or related information in the operation command is wrong or the write data is not in the setting range.
H'04	Operation error	The write data contents are not allowed in the present operation mode. <ul style="list-style-type: none"> • The Communications Writing parameter is set to "OFF" (disabled). • Attempted to write to a parameter in setup area 1 from setup area 0. • Attempted to write to a protect parameter from other than the protect level. • AT execution is in progress. • The command cannot be processed.

● No Response

In the following cases, the received command will not be processed and a response will not be returned.

Consequently, a timeout error will occur at the host device.

- The slave address in the received command does not match the communications unit number.
- A parity error, framing error, or overrun error occurred due to a problem such as a transfer error.
- A CRC-16 code error occurred in the received command frame.
- There was a time interval of more than 3.5 character times between data packets that make up the command frame.

Furthermore, the specified function's processing will be performed but no response will be returned for broadcast functions (slave address = H'00).

4-2 Function List

The following table lists the function codes.

Function Code List

Function code	Name	Process
03 (H'03)	Read variable (multiple)	This function reads from the variable area. It is possible to read two or more consecutive variables.
16 (H'10)	Write variable (multiple)	This function writes to the variable area. It is possible to write two or more consecutive variables. It is also possible to broadcast this function (broadcast transmission).
06 (H'06)	Write variable (Single/operation command)	This function writes to the variable area and writes operation commands. It is also possible to write to a single parameter by specifying the address in 2-byte mode. (This is not supported in 4-byte mode.) It is also possible to broadcast this function (broadcast transmission.)
08 (H'08)	Echoback Test	This function performs an echoback test.

4-3 Variable Area

The variable area is the region of memory used to exchange data with the E5□C-T through communications.

Operations such as reading the process value and reading/writing parameters are performed on the variable area.

On the other hand, operation commands do not use the variable area.

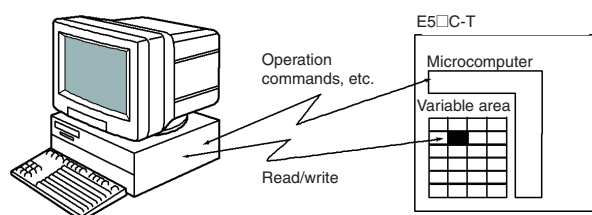

When accessing the variable area, the position of a variable in the variable area is specified with a word identifier, area number, and address in the area.

● Addresses

An address is appended to each of the variable types. Express addresses in 2-byte hexadecimal and append them for the specified access size.

● Number of Elements

The number of elements is expressed in 2-byte hexadecimal. The setting range for the number of elements varies according to the command.

Four-byte Mode

One element uses 2 bytes of data, so specify two-element units. Reading and writing in 4-byte units is executed by specifying an even address and specifying the number of elements in multiples of 2.

Two-byte Mode

One element uses 2 bytes of data, so specify one-element units. Reading and writing in 2-byte data units is executed by specifying 1-element units.

● Set Values

The values read from the variable area or written to the variable area are expressed in hexadecimal, ignoring the decimal point position. (Negative values are expressed in 2's complement format.)

Example: D'105.0 → H'0000041A

The variables are 4-digit or 8-digit hexadecimal values. Negative values are expressed in 2's complement format. The values are hexadecimal values with no decimal point indication.

For example, if the E5□C-T's process value is read in 4-byte mode when the process value is 105.0, the read value will be H'0000041A (105.0 → 1050 → H'0000041A).

However, values that are read or written when the unit is hours:minutes, minutes:seconds, or days:hours will be in BCD, the same as the display values.

Example, if 99.59 is displayed, the set value is H'00009959.

4-4 Detailed Description of the Services

4-4-1 Variable Read, Multiple

To read from the variable area, set the required data in the command frame, as shown in the following diagram.

Command Frame

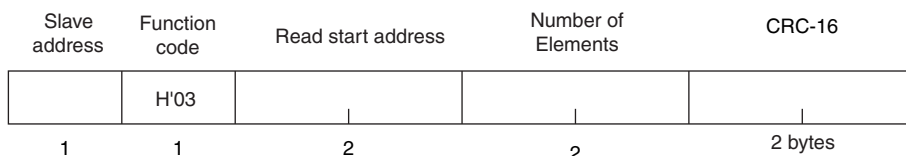

Name	Description
Slave address	Specify the E5□C-T's unit number. The unit number can be set between H'01 and H'63 hexadecimal (1 to 99 decimal).
Function code	The Read Variable Area function's function code is H'03.
Read start address	Specify the address containing the data to be read. Refer to <i>Section 5 Communications Data for Modbus</i> for details on addresses.
Number of elements	<p>4-byte Mode Specify 2 times the number of setting data items as the number of elements to be read. The setting range for the number of elements is H'0002 to H'006A (2 to 106). When H'006A is set, 53 items of setting data can be read. Example: When reading 2 items of setting data, set the number of elements to H'0004.</p> <p>2-byte Mode Specify the number of setting data items to be read as the number of elements. The setting range for the number of elements is H'0001 to H'006A (1 to 106). When H'006A is set, 106 items of setting data can be read. Example: When reading two items of setting data, set the number of elements to H'0002.</p>
CRC-16	This check code is calculated with the data from the slave address to the end of the data. For details on the CRC-16 calculation, refer to <i>CRC-16 Calculation Example</i> in 4-1-1 <i>Command Frame</i> on page 4-2.

Response Frame

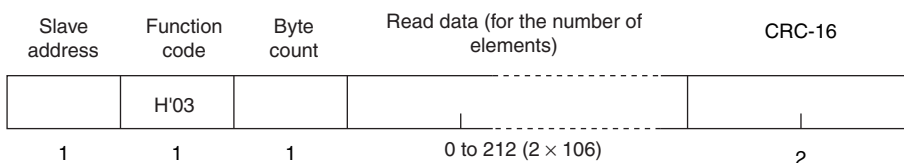

Name	Description
Slave address	The value from the command frame is entered as-is.
Function code	This is the received function code. When the function ended normally, the function code is left as-is. When an error occurred, the hexadecimal value of H'80 is added to the function code to indicate that the response is an error response. Example: Received function code = H'03 Function code in response frame when an error occurred = H'83
Byte count	Contains the number of bytes of read data.
Read data	Contains the number of setting data items that were read.
CRC-16	This check code is calculated with the data from the slave address to the end of the data. For details on the CRC-16 calculation, refer to <i>CRC-16 Calculation Example</i> in 4-1-1 <i>Command Frame</i> on page 4-2.

Response Code

Function code	Error code	Error name	Cause
H'83	H'02	Variable address error	The read start address is incorrect.
	H'03	Variable data error	The number of elements exceeds the allowed range.
H'03	---	Normal completion	No errors were found.

Reading Undisplayed Parameters

It is possible to read the parameters that are not displayed due to display settings as well as the parameters that are never displayed in the Controller.

- Example Command and Response

The following example shows the command and response when reading the process value (slave address: H'01).

Process Value in 4-byte Mode

- Address: H'0000; Read data: H'000003E8 (100.0 °C)

Command:

01	03	00 00	00 02	C4 0B(CRC-16)
----	----	-------	-------	---------------

Response:

01	03	04	00 00 03 E8	FA 8D(CRC-16)
----	----	----	-------------	---------------

Process Value in 2-byte Mode

- Address: H'2000; Read data: H'03E8 (100.0 °C)

Command:

01	03	20 00	00 01	8FCA(CRC-16)
----	----	-------	-------	--------------

Response:

01	03	02	03 E8	B8 FA(CRC-16)
----	----	----	-------	---------------

4-4-2 Variable Write, Multiple

To write data to the variable area, set the required data in the command frame, as shown in the following diagram.

Command Frame

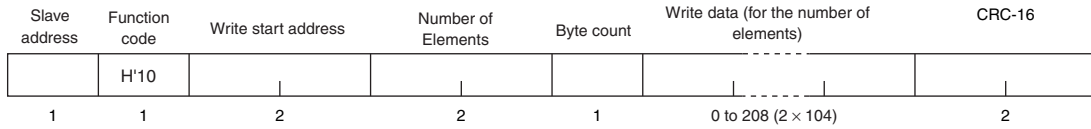

Name	Description
Slave address	Specify the E5□C-T's unit number. The unit number can be set between H'01 and H'63 hexadecimal (1 to 99 decimal).
Function code	The Write Variable Area function's function code is H'10.
Write start address	Specify the starting address where the setting data will be written. Refer to <i>Section 5 Communications Data for Modbus</i> for details on addresses.
Number of elements	<p>4-byte Mode</p> <p>Specify 2 times the number of setting data items as the number of elements to be written.</p> <p>The setting range for the number of elements is H'0002 to H'0068 (2 to 104). When H'0068 is set, 52 items of setting data can be read. Example: When writing 2 items of setting data, set the number of elements to H'0004.</p> <p>2-byte Mode</p> <p>Specify the number of setting data items to be written as the number of elements.</p> <p>The setting range for the number of elements is H'0001 to H'0068 (1 to 104). When H'0068 is set, 104 items of setting data can be read. Example: When reading two items of setting data, set the number of elements to H'0002.</p>
Byte count	Specify the number of bytes of write data.
CRC-16	This check code is calculated with the data from the slave address to the end of the data. For details on the CRC-16 calculation, refer to <i>CRC-16 Calculation Example</i> in <i>4-1-1 Command Frame</i> on page 4-2.

● Response Frame

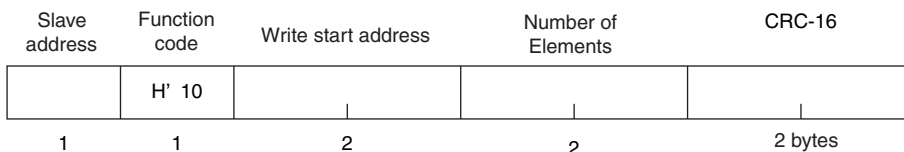

Name	Description
Slave address	The value from the command frame is entered as-is.
Function code	This is the received function code. When the function ended normally, the function code is left as-is. When an error occurred, the hexadecimal value of H'80 is added to the function code to indicate that the response is an error response. Example: Received function code = H'10 Function code in response frame when an error occurred = H'90
Write start address	This is the received write start address.
Number of elements	This is the received number of elements.
CRC-16	This check code is calculated with the data from the slave address to the end of the data. For details on the CRC-16 calculation, refer to <i>CRC-16 Calculation Example</i> in 4-1-1 Command Frame on page 4-2.

Response Code

Function code	Error code	Error name	Cause
H'90	H'02	Variable address error	The write start address is incorrect.
	H'03	Variable data error	<ul style="list-style-type: none"> • The amount of data does not match the number of elements. • The byte count is not 2 times the number of elements. • The write data is out of the setting range.
	H'04	Operation error	The Controller cannot write the data in its present operating status. The write data contents are not allowed in the present operation mode. <ul style="list-style-type: none"> • The Communications Writing parameter is set to "OFF" (disabled). • Attempted to write to a parameter in setup area 1 from setup area 0. • Attempted to write to a protect parameter from other than the protect level. • AT execution is in progress. • The Program No. parameter was written during operation.
H'10	---	Normal completion	No errors were found.

Writing Undisplayed Parameters

It is possible to write the parameters that are not displayed due to display settings as well as the parameters that are never displayed in the Controller.

- Example Command and Response

The following example shows the command/response when writing the Alarm Value Upper Limit 1 and Alarm Value Lower Limit 1 parameters.

(In this case, the slave address is H'01.)

Four-byte Mode

Alarm Value Upper Limit 1

- Address: H'010A; Write data: H'000003E8 (when 1000)

Alarm Value Lower Limit 1

- Address: H'010C; Write data: H'FFFFFFC18 (when -1000)

Command:	01	10	01 0A	00 04	08	00 00 03 E8	FF FF FC 18	8D E9(CRC-16)
Response:	01	10	01 0A	00 04	E0 34(CRC-16)			

Two-byte Mode

Alarm Value Upper Limit 1

- Address: H'2105; Write data: H'03E8 (when 1000)

Alarm Value Lower Limit 1

- Address: H'2106; Write data: H' FC18 (when -1000)

Command:	01	10	21 05	00 02	04	03 E8	FC 18	66 BB(CRC-16)
Response:	01	10	21 05	00 02	5B F5(CRC-16)			

4-4-3 Variable Write, Single/Operation Command

This function performs operations such as writing to the variable area (single) and operation commands (communications writing, RUN/RESET, AT execute/cancel, write mode, save RAM data, software reset, move to setup area 1, move to protect level, auto/manual switch, initialize settings, alarm latch cancel, SP mode, invert direct/reverse operation, hold, and advance.)

Writing is enabled in only the 2-byte mode.

Command Frame

Slave address	Function code	Write variable address	Write data	CRC-16
1	H'06	2	2	2 bytes

Response Frame

Slave address	Function code	Write variable address	Write data	CRC-16
1	H'06	2	2	2 bytes

(1) Write variable address

Specify the address of the setting data that is to be written. For details on addresses, refer to *Section 5 Modbus Communications Procedure*.

For an operation command, specify 0000 or FFFF.

(2) Command Code and Related Information

This information is the same as that for CompoWay/F. Refer to page 2-16.

(3) Response Code

- Normal Completion

Function code	Error code	Name	Description
H'06	---	Normal completion	No errors were found.

- Error Occurred

Function code	Error code	Name	Description
H'86	H'02	Variable address error	The write variable address is incorrect.
	H'03	Variable data error	The write data is incorrect. <ul style="list-style-type: none"> • The write data is out of the setting range. • Command code or related information are incorrect.
	H'04	Operation error	The Controller cannot write the data in its present operating status. <ul style="list-style-type: none"> • The Communications Writing parameter is set to "OFF" (disabled). The command is received regardless of the Communications Writing parameter setting (ON/OFF). • Attempted to write to a parameter in setup area 1 from setup area 0. • Attempted to write to a protect parameter from other than the protect level. • AT execution is in progress. • The command cannot be processed. For details, refer to (5) <i>Operation Commands and Precautions</i> following this table.

Note: For details on variable writing, refer to 4-4-2 *Variable Write, Multiple*. For details on AT, refer to the *E5□C-T Digital Temperature Controllers User's Manual Basic Type* (Cat. No. H185).

(4) Example Command and Response

The following example shows the command/response for a RESET command. (In this case, the slave address is H'01.)

RESET command (command code: 01; related information: 01)

- Address: H'0000 (fixed)

Write data: H'0101 (RUN/RESET, RESET command)

Command:

01	06	00 00	01 01	49 9A(CRC-16)
----	----	-------	-------	---------------

Response:

01	06	00 00	01 01	49 9A(CRC-16)
----	----	-------	-------	---------------

(5) Operation Commands and Precautions

This information is the same as that for CompoWay/F. Refer to page 2-18.

4-4-4 Echoback Test

Command Frame

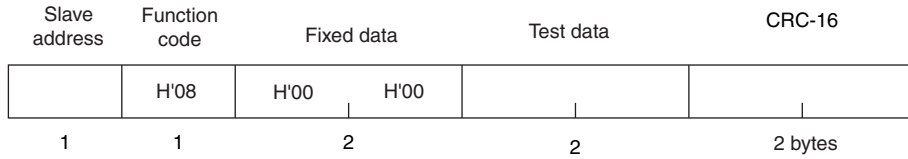

Response Frame

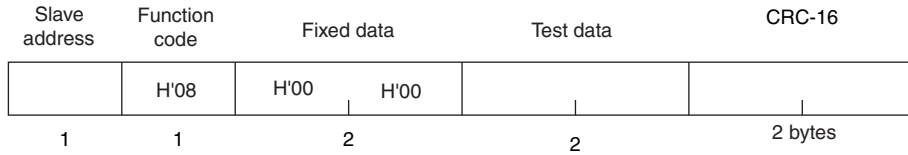

Note: When the command is executed normally, the response returns the same data sent in the command.

(1) Test Data

Enter any 2-byte hexadecimal data.

(2) Response Code

Function code	Error code	Name	Description
H'88	H'03	Variable data error	A different value (not H'00, H'00) was returned.
H'08	---	Normal completion	No errors were found.

(3) Example Command and Response

The following example shows the command/response for an Echoback Test command.

(In this case, the test data is H'1234.)

(In this case, the slave address is H'01.)

Command:

01	08	00 00	12 34	ED 7C(CRC-16)
----	----	-------	-------	---------------

Response:

01	08	00 00	12 34	ED 7C(CRC-16)
----	----	-------	-------	---------------

5

Communications Data for Modbus

This section lists the details of the communications data in the Modbus communications protocol.

5-1 Variable Area (Setting Range) List	5-2
5-2 Status	5-21

5-1 Variable Area (Setting Range) List

- Four-byte Mode
One element uses 4 bytes of data (H'00000000 to H'FFFFFFFF), so specify two-element units. Reading and writing in 4-byte units is executed by specifying an even address and specifying the number of elements in multiples of 2.
- Two-byte Mode
One element uses 2 bytes of data (H'0000 to H'FFFF), so specify one-element units. Reading and writing in 2-byte data units is executed by specifying 1-element units.

The following table lists the variable area. Items expressed in hexadecimal in the "Setting (monitor) value" column are the setting range in the Modbus specifications. Values in parentheses "(") are the actual setting range.

When there is a section reference for a setting item, refer to that reference for details.

Address		Parameter name	Setting (monitor) value	Level
Four-byte mode	Two-byte mode			
0000	2000	PV	Temperature: Use the specified range for each sensor. Analog: Scaling lower limit – 5% FS to Scaling upper limit + 5% FS	Operation
0002	2001	Status ^{*1*2}	Refer to 5-2 Status for details.	
0004	2002	Present SP ^{*1}	SP lower limit to SP upper limit	
0006	2003	Heater Current 1 Value Monitor	H'00000000 to H'00000226 (0.0 to 55.0)	
0008	2004	MV Monitor (Heating)	Standard: H'FFFFFFCE to H'0000041A (–5.0 to 105.0) Heating and cooling: H'00000000 to H'0000041A (0.0 to 105.0)	
000A	2005	MV Monitor (Cooling)	H'00000000 to H'0000041A (0.0 to 105.0)	
0404	2402	PV	Temperature: Use the specified range for each sensor. Analog: Scaling lower limit – 5% FS to Scaling upper limit + 5% FS	
0406	2403	Present SP ^{*1}	SP lower limit to SP upper limit	
0408	2404	Program No. Monitor	H'00000000 to H'00000007 (0 to 7)	None
040A	2405	PID Set No. Monitor	H'00000001 to H'00000008 (1 to 8)	
040C	2406	Status ^{*1*2}	Refer to 5-2 Status for details.	Operation
040E	2407	Status ^{*1*3}	Refer to 5-2 Status for details.	
0410	2408	Status 2 ^{*1*2}	Refer to 5-2 Status for details.	
0412	2409	Status 2 ^{*1*3}	Refer to 5-2 Status for details.	
0420	2410	Decimal Point Monitor	H'00000000 to H'00000003 (0 to 3)	
0500	2500	Operation/Adjustment Protect	H'00000000 (0) to H'00000005 (5) 0: No control 1: Operation level (PV displayed, PV/SP allowed, others allowed), program level allowed, adjustment level allowed, PID setting level prohibited 2: Operation level (PV displayed, PV/SP allowed, others allowed), program level allowed, adjustment level prohibited, PID setting level prohibited 3: Operation level (PV displayed, PV/SP allowed, others allowed), program level prohibited, adjustment level prohibited, PID setting level prohibited 4: Operation level (PV displayed, PV/SP allowed, others prohibited), program level prohibited, adjustment level prohibited, PID setting level prohibited 5: Operation level (PV displayed, PV/SP displayed, others prohibited), program level prohibited, adjustment level prohibited, PID setting level prohibited	

*1 Not displayed on the Controller display.

*2 In 2-byte mode, the rightmost 16 bits are read.

*3 In 2-byte mode, the leftmost 16 bits are read.

Address		Parameter name	Setting (monitor) value	Level
Four-byte mode	Two-byte mode			
0502	2501	Initial Setting/Communications Protect	H'00000000 (0): Move to initial setting/communications setting level is allowed. (Move to advanced function setting level is displayed.) H'00000001 (1): Move to initial setting/communications setting level is allowed. (Move to advanced function setting level is not displayed.) H'00000002 (2): Move to initial setting/communications setting level is prohibited.	Protect
0504	2502	Setting Change Protect	H'00000000 (0): OFF (Changing of setup on controller display is allowed.) H'00000001 (1): ON (Changing of setup on controller display is prohibited.)	
0506	2503	PF Key Protect	H'00000000 (0): OFF H'00000001 (1): ON	
0508	2504	Move to Protect Level	H'FFFFFF831 to H'0000270F (-1999 to 9999)	
050A	2505	Password to Move to Protect Level	H'FFFFFF831 to H'0000270F (-1999 to 9999) (Can only be set. The monitor value is always H'00000000.)	
050C	2506	Parameter Mask Enable	H'00000000 (0): OFF H'00000001 (1): ON	
0600	2600	Manual MV	Standard Models Standard control: H'FFFFFFCE to H'0000041A (-5.0 to 105.0) Heating and cooling control: H'FFFFFFBE6 to H'0000041A (-105.0 to 105.0) Position-proportional Models Close position-proportional control with the Direct Setting of Position Proportional MV parameter set to ON: H'FFFFFFCE to H'0000041A (-5.0 to 105.0)	Manual control
0608	2604	Heater Current 1 Value Monitor	H'00000000 to H'00000226 (0.0 to 55.0)	Operation
060A	2605	MV Monitor (Heating)	Standard control: H'FFFFFFCE to H'0000041A (-5.0 to 105.0) Heating and cooling control: H'00000000 to H'0000041A (0.0 to 105.0)	
060C	2606	MV Monitor (Cooling)	H'00000000 to H'0000041A (0.0 to 105.0)	
060E	2607	Valve Opening Monitor	H'FFFFFFF9C to H'0000044C (-10.0 to 110.0)	
0610	2608	Program No.	H'00000000 to H'00000007 (0 to 7)	
0612	2609	Segment No. Monitor	H'00000000 to H'0000001F (0 to 31)	
0614	260A	Remaining Standby Time Monitor	H'00000000 to H'00009959 (hours, minutes) H'00000000 to H'00009923 (days, hours)	
0616	260B	Elapsed Program Time Monitor	H'00000000 to H'00009959	
0618	260C	Remaining Program Time Monitor	H'00000000 to H'00009959	None
061A	260D	Elapsed Segment Time Monitor	H'00000000 to H'00009959	
061C	260E	Remaining Segment Time Monitor	H'00000000 to H'00009959	
061E	260F	Program Execution Repetitions Monitor	H'00000000 to H'0000270F (0 to 9999)	Operation

Address		Parameter name	Setting (monitor) value	Level	
Four-byte mode	Two-byte mode				
0620	2610	SP Mode Setting Monitor (SP Mode)	H'00000000 (0): Program SP mode H'00000001 (1): Fixed SP mode	Adjustment	
0702	2701	Proportional Band (Cooling) ^{*1}	H'00000001 to H'0000270F (0.1 to 999.9)		
0704	2702	Integral Time (Cooling) ^{*1}	H'00000000 to H'0000270F (0 to 9999: Integral/derivative time unit is 1 s.) (0.0 to 999.9: Integral/derivative time unit is 0.1 s.)		
0706	2703	Derivative Time (Cooling) ^{*1}	H'00000000 to H'0000270F (0 to 9999: Integral/derivative time unit is 1 s.) (0.0 to 999.9: Integral/derivative time unit is 0.1 s.)		
0708	2704	Dead Band ^{*1}	H'FFFFFF831 to H'0000270F (-199.9 to 999.9 for temperature input) (-19.99 to 99.99 for analog input)		
070A	2705	Manual Reset Value ^{*1}	H'00000000 to H'000003E8 (0.0 to 100.0)		
070C	2706	Hysteresis (Heating)	H'00000001 to H'0000270F (0.1 to 999.9 for temperature input) (0.01 to 99.99 for analog input)		
070E	2707	Hysteresis (Cooling)	H'00000001 to H'0000270F (0.1 to 999.9 for temperature input) (0.01 to 99.99 for analog input)		
0710	2708	Control Period (Heating)	H'FFFFFFFE (-2): 0.1 s H'FFFFFFF (-1): 0.2 s H'00000000 (0): 0.5 s H'00000001 to H'00000063 (1 to 99)		Initial setting
0712	2709	Control Period (Cooling)	H'FFFFFFFE (-2): 0.1 s H'FFFFFFF (-1): 0.2 s H'00000000 (0): 0.5 s H'00000001 to H'00000063 (1 to 99)		
0714	270A	Position Proportional Dead Band	H'00000001 to H'00000064 (0.1 to 10.0)	Adjustment	
0716	270B	Open/Close Hysteresis	H'00000001 to H'000000C8 (0.1 to 20.0)		
071E	270F	MV at Reset	Standard Models		
0722	2711	MV at PV Error	Standard control: H'FFFFFFCE to H'0000041A (-5.0 to 105.0) Heating and cooling control: H'FFFFFFBE6 to H'0000041A (-105.0 to 105.0) Position-proportional Models Close position-proportional control with the Direct Setting of Position Proportional MV parameter set to ON: H'FFFFFFCE to H'0000041A (-5.0 to 105.0) Floating position-proportional control or the Direct Setting of Position Proportional MV parameter set to OFF: H'FFFFFFF to H'00000001 (-1 to 1)		
0726	2713	MV Change Rate Limit	H'00000000 to H'000003E8 (0.0 to 100.0)		
0730	2718	PV Slope Coefficient	H'00000001 to H'0000270F (0.001 to 9.999)		
0734	271A	Heater Current 1 Value Monitor	H'00000000 to H'00000226 (0.0 to 55.0)		
0736	271B	Heater Burnout Detection 1	H'00000000 to H'000001F4 (0.0 to 50.0)	Adjustment	
0738	271C	Leakage Current 1 Monitor	H'00000000 to H'00000226 (0.0 to 55.0)	Operation	
073A	271D	HS Alarm 1	H'00000000 to H'000001F4 (0.0 to 50.0)	Adjustment	
0746	2723	Process Value Input Shift	H'FFFFFF831 to H'0000270F (-1999 to 9999)		
0748	2724	Heater Current 2 Value Monitor	H'00000000 to H'00000226 (0.0 to 55.0)	Operation	
074A	2725	Heater Burnout Detection 2	H'00000000 to H'000001F4 (0.0 to 50.0)	Adjustment	
074C	2726	Leakage Current 2 Monitor	H'00000000 to H'00000226 (0.0 to 55.0)	Operation	

*1 The parameter for the currently selected PID set will be accessed. For setup area 1, however, the currently selected PID set is fixed at PID1.

Address		Parameter name	Setting (monitor) value	Level
Four-byte mode	Two-byte mode			
074E	2727	HS Alarm 2	H'00000000 to H'000001F4 (0.0 to 50.0)	Adjustment
0754	272A	Wait Band	H'00000000 (0): OFF H'00000001 to H'0000270F (0.1 to 999.9 for Temperature input) (0.01 to 99.99 for Analog input)	
075A	272D	Fixed SP	SP lower limit to SP upper limit	
075C	272E	Standby Time	H'00000000 to H'00009959 (hours, minutes) H'00000000 to H'00009923 (days, hours)	
075E	272F	Program SP Shift Value	H'FFFFFF831 to H'0000270F (-1999 to 9999)	
0800	2800	Input Digital Filter	H'00000000 to H'0000270F (0.0 to 999.9)	Advanced function setting
0808	2804	Moving Average Count	H'00000000 (0): OFF H'00000001 (1): 2 times H'00000002 (2): 4 times H'00000003 (3): 8 times H'00000004 (4): 16 times H'00000005 (5): 32 times	
0810	2808	Extraction of Square Root Low-cut Point	H'00000000 to H'000003E8 (0.0 to 100.0)	Adjustment
1800	3800	Program Selection	H'00000000 to H'00000007 (0 to 7)	Program
1802	3801	Number of Segments Used ^{*1}	H'00000001 to H'00000020 (32)	
1804	3802	Segment Selection ^{*1}	H'00000000 to H'0000001F (31)	
1806	3803	Segment Format ^{*2}	H'00000000 (0): Ramp H'00000001 (1): Soak H'00000002 (2): Step	
1808	3804	Segment SP ^{*2}	SP Lower Limit to SP Upper Limit	
180A	3805	Segment Slope ^{*2}	H'00000000 to H'0000270F (0 to 9999)	
180C	3806	Segment Time ^{*2}	H'00000000 to H'00009959 (0.00 to 99.59) (hours, minutes) H'00000000 to H'00009959 (0.00 to 99.59) (minutes, seconds)	
180E	3807	PID Set No. ^{*1}	H'00000000 to H'00000008 (0 to 8), (0): Automatic selection	
1810	3808	Alarm Value 1 ^{*1}	H'FFFFFF831 to H'0000270F (-1999 to 9999)	
1812	3809	Alarm Value Upper Limit 1 ^{*1}	H'FFFFFF831 to H'0000270F (-1999 to 9999)	
1814	380A	Alarm Value Lower Limit 1 ^{*1}	H'FFFFFF831 to H'0000270F (-1999 to 9999)	
1816	380B	Alarm Value 2 ^{*1}	H'FFFFFF831 to H'0000270F (-1999 to 9999)	
1818	380C	Alarm Value Upper Limit 2 ^{*1}	H'FFFFFF831 to H'0000270F (-1999 to 9999)	
181A	380D	Alarm Value Lower Limit 2 ^{*1}	H'FFFFFF831 to H'0000270F (-1999 to 9999)	
181C	380E	Alarm Value 3 ^{*1}	H'FFFFFF831 to H'0000270F (-1999 to 9999)	
181E	380F	Alarm Value Upper Limit 3 ^{*1}	H'FFFFFF831 to H'0000270F (-1999 to 9999)	
1820	3810	Alarm Value Lower Limit 3 ^{*1}	H'FFFFFF831 to H'0000270F (-1999 to 9999)	
1822	3811	Alarm Value 4 ^{*1}	H'FFFFFF831 to H'0000270F (-1999 to 9999)	
1824	3812	Alarm Value Upper Limit 4 ^{*1}	H'FFFFFF831 to H'0000270F (-1999 to 9999)	
1826	3813	Alarm Value Lower Limit 4 ^{*1}	H'FFFFFF831 to H'0000270F (-1999 to 9999)	
1828	3814	Program Repetitions ^{*1}	H'00000000 to H'0000270F (0 to 9999)	
182A	3815	Program Link Destination No. ^{*1}	H'FFFFFFF (-1): No link H'00000000 to H'00000007 (0 to 7)	

*1 The set values for the program specified in the Program Selection parameter are accessed for the following parameters: No. of Segments Used, Segment Selection, PID Set No., Alarm Values 1 to 4, Alarm Upper Limits 1 to 4, Alarm Lower Limits 1 to 4, Program Repetitions, Program Link Destination No., Time Signal 1 and 2 Set Segments, Time Signal 1 and 2 ON Times, and Time Signal 1 and 2 OFF Times. Check the set value of the Program Selection parameter before accessing these parameters.

*2 The set values for the program specified in the Program Selection parameter and the section specified in the Segment Selection parameter are accessed for the following parameters: Segment Type, Segment SP, Segment Slope, and Segment Time. Check the set value of the Program Selection and Segment Selection parameters before accessing these parameters.

Address		Parameter name	Setting (monitor) value	Level
Four-byte mode	Two-byte mode			
182C	3816	Program 0 Time Signal 1 Set Segment ^{*1}	H'00000000 (0) to No. of segments used – 1	
182E	3817	Program 0 Time Signal 1 ON Time ^{*1}	H'00000000 to H'00009959 (0.00 to 99.59) (hours, minutes) H'00000000 to H'00009959 (0.00 to 99.59) (minutes, seconds)	
1830	3818	Program 0 Time Signal 1 OFF Time ^{*1}	H'00000000 to H'00009959 (0.00 to 99.59) (hours, minutes) H'00000000 to H'00009959 (0.00 to 99.59) (minutes, seconds)	
1832	3819	Program 0 Time Signal 2 Set Segment ^{*1}	H'00000000 (0) to No. of segments used – 1	Program
1834	381A	Program 0 Time Signal 2 ON Time ^{*1}	H'00000000 to H'00009959 (0.00 to 99.59) (hours, minutes) H'00000000 to H'00009959 (0.00 to 99.59) (minutes, seconds)	
1836	381B	Program 0 Time Signal 2 OFF Time ^{*1}	H'00000000 to H'00009959 (0.00 to 99.59) (hours, minutes) H'00000000 to H'00009959 (0.00 to 99.59) (minutes, seconds)	

Note: The alarm function can also be used in Controllers without alarm output terminals. In this case, confirm alarm occurrences via the status data.

- *1 The set values for the program specified in the Program Selection parameter are accessed for the following parameters: No. of Segments Used, Segment Selection, PID Set No., Alarm Values 1 to 4, Alarm Upper Limits 1 to 4, Alarm Lower Limits 1 to 4, Program Repetitions, Program Link Destination No., Time Signal 1 and 2 Set Segments, Time Signal 1 and 2 ON Times, and Time Signal 1 and 2 OFF Times. Check the set value of the Program Selection parameter before accessing these parameters.

Address		Parameter name	Setting (monitor) value	Level
Four-byte mode	Two-byte mode			
0A00	2A00	Proportional Band ^{*1}	H'00000001 to H'0000270F (0.1 to 999.9)	
0A02	2A01	Integral Time ^{*1}	Standard, heating/cooling, or close position proportional control: H'00000000 to H'0000270F (0 to 9999: Integral/derivative time unit is 1 s.) (0.0 to 999.9: Integral/derivative time unit is 0.1 s.) Floating position-proportional control: H'00000001 to H'0000270F (1 to 9999: Integral/derivative time unit is 1 s.) (0.1 to 999.9: Integral/derivative time unit is 0.1 s.)	
0A04	2A02	Derivative Time ^{*1}	H'00000000 to H'0000270F (0 to 9999: Integral/derivative time unit is 1 s.) (0.0 to 999.9: Integral/derivative time unit is 0.1 s.)	
0A0A	2A05	MV Upper Limit ^{*1}	Standard control or close position-proportional control: MV lower limit + 0.1 to H'0000041A (MV lower limit + 0.1 to 105.0) Heating and cooling control: H'00000000 to H'0000041A (0.0 to 105.0)	
0A0C	2A06	MV Lower Limit ^{*1}	Standard control or close position-proportional control: H'FFFFFFCE to MV upper limit -0.1 (-5.0 to MV upper limit -0.1) Heating and cooling control: H'FFFFFFBE6 to H'00000000 (-105.0 to 0.0)	

*1 The parameter for the currently selected PID set will be accessed. For setup area 1, however, the currently selected PID set is fixed at PID1.

Address		Parameter name	Setting (monitor) value	Level
Four-byte mode	Two-byte mode			
0C00	2C00	Input Type	H'00000000 (0): Pt (–200 to 850°C/–300 to 1500°F) H'00000001 (1): Pt (–199.9 to 500.0°C/–199.9 to 900.0°F) H'00000002 (2): Pt (0.0 to 100.0°C/0.0 to 210.0°F) H'00000003 (3): JPt (–199.9 to 500.0°C/–199.9 to 900.0°F) H'00000004 (4): JPt (0.0 to 100.0°C/0.0 to 210.0°F) H'00000005 (5): K (–200 to 1300°C/–300 to 2300°F) H'00000006 (6): K (–20.0 to 500.0°C/0.0 to 900.0°F) H'00000007 (7): J (–100 to 850°C/–100 to 1500°F) H'00000008 (8): J (–20.0 to 400.0°C/0.0 to 750.0°F) H'00000009 (9): T (–200 to 400°C/–300 to 700°F) H'0000000A (10): T (–199.9 to 400.0°C/–199.9 to 700.0°F) H'0000000B (11): E (–200 to 600°C/–300 to 1100°F) H'0000000C (12): L (–100 to 850°C/–100 to 1500°F) H'0000000D (13): U (–200 to 400°C/–300 to 700°F) H'0000000E (14): U (–199.9 to 400.0°C/–199.9 to 700.0°F) H'0000000F (15): N (–200 to 1300°C/–300 to 2300°F) H'00000010 (16): R (0 to 1700°C/0 to 3000°F) H'00000011 (17): S (0 to 1700°C/0 to 3000°F) H'00000012 (18): B (100 to 1800°C/300 to 3200°F) H'00000013 (19): W (0 to 2,300°C/0 to 3,200°F) H'00000014 (20): PLII (0 to 1,300°C/0 to 2,300°F) H'00000015 (21): Infrared temperature sensor (K 140°F/60°C) H'00000016 (22): Infrared temperature sensor (K 240°F/120°C) H'00000017 (23): Infrared temperature sensor (K 280°F/140°C) H'00000018 (24): Infrared temperature sensor (K 440°F/220°C) H'00000019 (25): 4 to 20 mA H'0000001A (26): 0 to 20 mA H'0000001B (27): 1 to 5 V H'0000001C (28): 0 to 5 V H'0000001D (29): 0 to 10 V	Initial setting
0C02	2C01	Temperature Unit	H'00000000 (0): °C H'00000001 (1): °F	
0C12	2C09	Scaling Lower Limit	H'FFFFFF831 to scaling upper limit – 1 (–1999 to scaling upper limit – 1)	
0C16	2C0B	Scaling Upper Limit	Scaling lower limit + 1 to H'0000270F (Scaling lower limit + 1 to 9999)	
0C18	2C0C	Decimal Point	H'00000000 to 00000003 (0 to 3)	
0C22	2C11	Burnout Method	H'00000000 (0): Upscale H'00000001 (1): Downscale	Initial setting
0D06	2D03	Control Output 1 Signal	H'00000000 (0): 4 to 20 mA H'00000001 (1): 0 to 20 mA	
0D08	2D04	Control Output 2 Signal	H'00000000 (0): 4 to 20 mA H'00000001 (1): 0 to 20 mA	
0D1E	2D0F	SP Upper Limit	The range of values (without decimal point) is as follows: Temperature input: SP lower limit + 1 to Input range upper limit Analog input: SP lower limit + 1 to Scaling upper limit	
0D20	2D10	SP Lower Limit	The range of values (without decimal point) is as follows: Temperature input: Input range lower limit to SP upper limit – 1 Analog input: Scaling lower limit to SP upper limit – 1	
0D22	2D11	Standard or Heating/Cooling	H'00000000 (0): Standard H'00000001 (1): Heating and cooling	
0D24	2D12	Direct/Reverse Operation	H'00000000 (0): Reverse operation H'00000001 (1): Direct operation	
0D26	2D13	Close/Floating	H'00000000 (0): Floating H'00000001 (1): Close	
0D28	2D14	PID ON/OFF	H'00000000 (0): ON/OFF H'00000001 (1): 2 PID control	

Address		Parameter name	Setting (monitor) value	Level
Four-byte mode	Two-byte mode			
0D32	2D19	Minimum Output ON/OFF Band	H'00000000 to H'000001F4 (0.0 to 50.0)	Advanced function setting
0D34	2D1A	Program Time Unit	H'00000000 (0): Hours, minutes H'00000001 (1): Minutes, seconds	Initial setting
0D36	2D1B	Step Time/Rate of Rise Programming	H'00000000 (0): Step time programming H'00000001 (1): Rate of rise programming	
0D38	2D1C	Time Unit of Ramp Rate	H'00000000 (0): Minutes H'00000001 (1): Hours	
0D3A	2D1D	PV Start	H'00000000 (0): SP start H'00000001 (1): PV start	
0D3C	2D1E	Reset Operation	H'00000000 (0): Stop control H'00000001 (1): Fixed SP operation	
0E00	2E00	Transfer Output Type	H'00000000 (0): OFF H'00000001 (1): Present SP H'00000002 (2): PV H'00000003 (3): MV (heating) H'00000004 (4): MV (cooling) H'00000005 (5): Valve opening (*Only for Position-proportional Models.)	
0E02	2E01	Transfer Output Signal	H'00000000 (0): 4 to 20 mA H'00000001 (1): 1 to 5 V	
0E0C	2E06	Control Output 1 Assignment	Control output 1 is a relay output or voltage output (for driving SSR): H'00000000 (0): Not assigned. H'00000001 (1): Control output (heating) H'00000002 (2): Control output (cooling) H'00000003 (3): Alarm 1 H'00000004 (4): Alarm 2 H'00000005 (5): Alarm 3 H'00000006 (6): Alarm 4 H'00000007 (7): Heater alarm H'00000008 (8): HB alarm H'00000009 (9): HS alarm H'0000000A (10): Input error H'0000000B (11): Program end output* H'0000000C (12): Stage output H'0000000D (13): RUN output H'0000000E (14): Time signal 1 output H'0000000F (15): Time signal 2 output H'00000010 (16): Integrated alarm H'00000011 (17): Work bit 1 H'00000012 (18): Work bit 2 H'00000013 (19): Work bit 3 H'00000014 (20): Work bit 4 H'00000015 (21): Work bit 5 H'00000016 (22): Work bit 6 H'00000017 (23): Work bit 7 H'00000018 (24): Work bit 8 When control output 1 is a linear current output: H'00000000 (0): Not assigned. H'00000001 (1): Control output (heating) H'00000002 (2): Control output (cooling)	Advanced function setting
0E0E	2E07	Control Output 2 Assignment	Control output 2 is a relay output or voltage output (for driving SSR): H'00000000 to H'00000018 (0 to 24) Note: Same as for the Control Output 1 Assignment parameter. When control output 2 is a linear current output: H'00000000 to H'00000002 (0 to 2) Note: Same as for the Control Output 1 Assignment parameter.	

Address		Parameter name	Setting (monitor) value	Level
Four-byte mode	Two-byte mode			
0E14	2E0A	Event Input Assignment 1	H'00000000 (0): None H'00000001 (1): RUN (OFF)/RESET (ON) H'00000002 (2): RUN (ON)/RESET (OFF) H'00000003 (3): Auto/Manual Switch H'00000004 (4): RESET H'00000005 (5): RUN H'00000006 (6): Hold/clear hold H'00000007 (7): Hold H'00000008 (8): Advance H'00000009 (9): Program No. switch 0 H'0000000A (10): Program No. switch 1 H'0000000B (11): Program No. switch 2 H'0000000C (12): Direct/reverse operation H'0000000D (13): Program SP mode/fixed SP mode H'0000001E (14): 100% AT execute/cancel H'0000001F (15): 40% AT execute/cancel H'00000010 (16): All PID 100% AT execute/cancel H'00000011 (17): All PID 40% AT execute/cancel H'00000012 (18): Setting Change Enable/Disable H'00000013 (19): Communications Writing Enable/Disable* ¹ H'00000014 (20): Alarm Latch Cancel H'00000015 (21): Wait enable (ON)/Disable (OFF)	Initial setting
0E16	2E0B	Event Input Assignment 2	H'00000000 to H'00000015 (0 to 21) Note: Same as for Event Input Assignment 1.	
0E18	2E0C	Event Input Assignment 3	H'00000000 to H'00000015 (0 to 21) Note: Same as for Event Input Assignment 1.	
0E1A	2E0D	Event Input Assignment 4	H'00000000 to H'00000015 (0 to 21) Note: Same as for Event Input Assignment 1.	
0E1C	2E0E	Event Input Assignment 5	H'00000000 to H'00000015 (0 to 21) Note: Same as for Event Input Assignment 1.	
0E1E	2E0F	Event Input Assignment 6	H'00000000 to H'00000015 (0 to 21) Note: Same as for Event Input Assignment 1.	
0E20	2E10	Auxiliary Output 1 Assignment	H'00000000 (0): Not assigned. H'00000001 (1): Control output (heating) H'00000002 (2): Control output (cooling) H'00000003 (3): Alarm 1 H'00000004 (4): Alarm 2 H'00000005 (5): Alarm 3 H'00000006 (6): Alarm 4 H'00000007 (7): Heater alarm H'00000008 (8): HB alarm H'00000009 (9): HS alarm H'0000000A (10): Input error H'0000000B (11): Program end output H'0000000C (12): Stage output H'0000000D (13): RUN output H'0000000E (14): Time signal 1 output H'0000000F (15): Time signal 2 output H'00000010 (16): Integrated alarm H'00000011 (17): Work bit 1 H'00000012 (18): Work bit 2 H'00000013 (19): Work bit 3 H'00000014 (20): Work bit 4 H'00000015 (21): Work bit 5 H'00000016 (22): Work bit 6 H'00000017 (23): Work bit 7 H'00000018 (24): Work bit 8	Advanced function setting
0E22	2E11	Auxiliary Output 2 Assignment	H'00000000 to H'00000018 (0 to 24) Note: Same as for the Auxiliary Output 1 Assignment parameter.	
0E24	2E12	Auxiliary Output 3 Assignment	H'00000000 to H'00000018 (0 to 24) Note: Same as for the Auxiliary Output 1 Assignment parameter.	
0E26	2E13	Auxiliary Output 4 Assignment	H'00000000 to H'00000018 (0 to 24) Note: Same as for the Auxiliary Output 1 Assignment parameter.	

*1 Valid only with external communications.

Address		Parameter name	Setting (monitor) value	Level
Four-byte mode	Two-byte mode			
0E28	2E14	Transfer Output Upper Limit	H'FFFFFF831 to H'0000270F (–1999 to 9999) *1	Initial setting
0E2A	2E15	Transfer Output Lower Limit	H'FFFFFF831 to H'0000270F (–1999 to 9999) *1	
0E48	2E24	Extraction of Square Root Enable	H'00000000 (0): OFF H'00000001 (1): ON	
0E52	2E29	Travel Time	H'00000001 to H'000003E7 (1 to 999)	
0E54	2E2A	Valve Completely Closed Position	H'00000000 to H'0000270F (0 to 9999)	
0E56	2E2B	Valve Completely Open Position	H'00000000 to H'0000270F (0 to 9999)	
0E58	2E2C	Potentiometer Specification Setting	H'00000000 to H'00000005 (0 to 5)	
0F00	2F00	Alarm 1 Type	H'00000000 (0): Alarm function OFF H'00000001 (1): Upper and lower-limit alarm H'00000002 (2): Upper-limit alarm H'00000003 (3): Lower-limit alarm H'00000004 (4): Upper and lower-limit range alarm H'00000005 (5): Upper and lower-limit alarm with standby sequence H'00000006 (6): Upper-limit alarm with standby sequence H'00000007 (7): Lower-limit alarm with standby sequence H'00000008 (8): Absolute-value upper-limit alarm H'00000009 (9): Absolute-value lower-limit alarm H'0000000A (10): Absolute-value upper-limit alarm with standby sequence H'0000000B (11): Absolute-value lower-limit alarm with standby sequence H'0000000C (12): LBA (Loop Burnout Alarm) H'0000000D (13): PV change rate alarm H'0000000E (14): SP absolute-value upper-limit alarm H'0000000F (15): SP absolute-value lower-limit alarm H'00000010 (16): MV absolute-value upper-limit alarm H'00000011 (17): MV absolute-value lower-limit alarm	
0F02	2F01	Alarm 1 Latch	H'00000000 (0): OFF H'00000001 (1): ON	Advanced function setting
0F04	2F02	Alarm 1 Hysteresis	H'00000001 to H'0000270F (0.1 to 999.9 for temperature input) (0.01 to 99.99 for analog input)	Initial setting
0F06	2F03	Alarm 2 Type	H'00000000 to H'00000011 (0 to 17) Note: Same settings as the Alarm 1 Type. However, the LBA (loop burnout alarm) cannot be set.	
0F08	2F04	Alarm 2 Latch	H'00000000 (0): OFF H'00000001 (1): ON	Advanced function setting
0F0A	2F05	Alarm 2 Hysteresis	H'00000001 to H'0000270F (0.1 to 999.9 for temperature input) (0.01 to 99.99 for analog input)	Initial setting
0F0C	2F06	Alarm 3 Type	H'00000000 to H'00000011 (0 to 17) Note: Same settings as the Alarm 1 Type. However, the LBA (loop burnout alarm) cannot be set.	
0F0E	2F07	Alarm 3 Latch	H'00000000 (0): OFF H'00000001 (1): ON	Advanced function setting
0F10	2F08	Alarm 3 Hysteresis	H'00000001 to H'0000270F (0.1 to 999.9 for temperature input) (0.01 to 99.99 for analog input)	Initial setting
0F12	2F09	Alarm 4 Type	H'00000000 to H'00000011 (0 to 17) Note: Same settings as the Alarm 1 Type. However, the LBA (loop burnout alarm) cannot be set.	

*1 The setting (monitor) range depends on the transfer output type setting. Refer to *Section 6 Parameters* in the *E5□C-T Digital Temperature Controller User's Manual* (Cat. No. H185).

Address		Parameter name	Setting (monitor) value	Level
Four-byte mode	Two-byte mode			
0F14	2F0A	Alarm 4 Latch	H'00000000 (0): OFF H'00000001 (1): ON	Advanced function setting
0F16	2F0B	Alarm 4 Hysteresis	H'00000001 to H'0000270F (0.1 to 999.9 for temperature input) (0.01 to 99.99 for analog input)	Initial setting
0F18	2F0C	Standby Sequence Reset	H'00000000 (0): Condition A H'00000001 (1): Condition B	Advanced function setting
0F1A	2F0D	Auxiliary Output 1 Open in Alarm	H'00000000 (0): Close in alarm H'00000001 (1): Open in alarm	
0F1C	2F0E	Auxiliary Output 2 Open in Alarm	H'00000000 (0): Close in alarm H'00000001 (1): Open in alarm	Advanced function setting
0F1E	2F0F	Auxiliary Output 3 Open in Alarm	H'00000000 (0): Close in alarm H'00000001 (1): Open in alarm	
0F20	2F10	Auxiliary Output 4 Open in Alarm	H'00000000 (0): Close in alarm H'00000001 (1): Open in alarm	
0F22	2F11	Alarm 1 ON delay	H'00000000 to H'000003E7 (0 to 999)	
0F24	2F12	Alarm 2 ON delay	H'00000000 to H'000003E7 (0 to 999)	
0F26	2F13	Alarm 3 ON delay	H'00000000 to H'000003E7 (0 to 999)	
0F28	2F14	Alarm 4 ON delay	H'00000000 to H'000003E7 (0 to 999)	
0F2A	2F15	Alarm 1 OFF delay	H'00000000 to H'000003E7 (0 to 999)	
0F2C	2F16	Alarm 2 OFF delay	H'00000000 to H'000003E7 (0 to 999)	
0F2E	2F17	Alarm 3 OFF delay	H'00000000 to H'000003E7 (0 to 999)	
0F30	2F18	Alarm 4 OFF delay	H'00000000 to H'000003E7 (0 to 999)	
1000	3000	PV/SP No. 1 Display Selection	H'00000000 (0): Nothing displayed. H'00000001 (1): PV/SP H'00000002 (2): PV H'00000003 (3): SP/SP (character display)/Nothing displayed H'00000004 (4): PV/SP/MV (heating) (valve opening for Position-proportional Models) H'00000005 (5): PV/SP/MV (cooling) H'00000006 (6): PV/SP/Program No. or segment No. H'00000007 (7): PV/SP/Remaining segment time	
1006	3003	Automatic Display Return Time	H'00000000 (0): OFF H'00000001 to H'00000063 (1 to 99)	
1008	3004	Display Refresh Period	H'00000000 (0): OFF H'00000001 (1): 0.25 H'00000002 (2): 0.5 H'00000003 (3): 1.0	
1010	3008	PV/SP No. 2 Display Selection	H'00000000 to H'00000007 (0 to 7) Note: Same as PV/SP No. 1 Display Selection.	
1014	300A	Display Brightness	H'00000001 to H'00000003 (1 to 3)	
1018	300C	Move to Protect Level Time	H'00000001 to H'0000001E (1 to 30)	
1022	3011	PV Status Display Function	H'00000000 (0): OFF H'00000001 (1): Manual H'00000002 (2): RESET H'00000003 (3): Alarm 1 H'00000004 (4): Alarm 2 H'00000005 (5): Alarm 3 H'00000006 (6): Alarm 4 H'00000007 (7): Alarm 1 to 4 OR status H'00000008 (8): Heater alarm H'00000009 (9): Standby	
1024	3012	SV Status Display Function	H'00000000 to H'00000009 (0 to 9) Note: Same as for PV Status Display Function.	

Address		Parameter name	Setting (monitor) value	Level
Four-byte mode	Two-byte mode			
1100	3100	Protocol Setting (See note.) ^{*1}	H'00000000 (0): CompoWay/F H'00000001 (1): Modbus H'00000002 (2): CMP H'00000003 (3): FINS H'00000004 (4): MCP4	Communications setting
1102	3101	Communications Unit No.	H'00000000 to H'00000063 (0 to 99)	
1104	3102	Communications Baud Rate ^{*1}	H'00000003 (3): 9.6 H'00000004 (4): 19.2 H'00000005 (5): 38.4 H'00000006 (6): 57.6	
1106	3103	Communications Data Length ^{*1}	H'00000007 (7): 7 H'00000008 (8): 8	
1108	3104	Communications Stop Bits ^{*1}	H'00000001 (1): 1 H'00000002 (2): 2	
110A	3105	Communications Parity ^{*1}	H'00000000 (0): None H'00000001 (1): Even H'00000002 (2): Odd	
110C	3106	Send Data Wait Time ^{*1}	H'00000000 to H'00000063 (0 to 99)	

^{*1} After communications parameters have been changed, reset the Digital Controller to enable them.

Address		Parameter name	Setting (monitor) value	Level
Four-byte mode	Two-byte mode			
1200	3200	PF Setting	H'00000000 (0): Disabled H'00000001 (1): Run H'00000002 (2): RESET H'00000003 (3): RUN/RESET H'00000004 (4): Hold/clear hold H'00000005 (5): Advance H'00000006 (6): 100% AT execute/cancel H'00000007 (7): 40% AT execute/cancel H'00000008 (8): All PID 100% AT execute/cancel H'00000009 (9): All PID 40% AT execute/cancel H'0000000A (10): Alarm latch cancel H'0000000B (11): Auto/manual switch H'0000000C (12): Monitor/setting item H'0000000D (13): Digit shift key	Advanced function setting
1204	3202	Monitor/Setting Item 1	H'00000000 (0): Disabled H'00000001 (1): PV/SP/Program No. monitor or segment No. monitor H'00000002 (2): PV/SP/MV (heating) (valve opening for Position-proportional Models) H'00000003 (3): PV/SP/MV (cooling) H'00000004 (4): PV/SP/Remaining segment time H'00000005 (5): Program No. H'00000006 (6): Segment No. monitor H'00000007 (7): Remaining standby time monitor H'00000008 (8): Elapsed program time monitor H'00000009(9): Remaining program time monitor H'0000000A (10): Elapsed segment time monitor H'0000000B (11): Remaining segment time monitor H'0000000C (12): Program execution repetitions monitor H'0000000D (13): Proportional band H'0000000E (14): Integral time H'0000000F (15): Derivative time H'00000010 (16): Proportional band (cooling) H'00000011 (17): Integral time (cooling) H'00000012 (18): Derivative time (cooling) H'00000013 (19): Alarm value 1 H'00000014 (20): Alarm value upper limit 1 H'00000015 (21): Alarm value lower limit 1 H'00000016 (22): Alarm value 2 H'00000017 (23): Alarm value upper limit 2 H'00000018 (24): Alarm value lower limit 2 H'00000019 (25): Alarm value 3 H'0000001A (26): Alarm value upper limit 3 H'0000001B (27): Alarm value lower limit 3 H'0000001C (28): Alarm value 4 H'0000001D (29): Alarm value upper limit 4 H'0000001E (30): Alarm value lower limit 4	
1206	3203	Monitor/Setting Item 2	H'00000000 to H'0000001E (0 to 30) Note: Same as for Monitor/Setting Item 1.	
1208	3204	Monitor/Setting Item 3	H'00000000 to H'0000001E (0 to 30) Note: Same as for Monitor/Setting Item 1.	
120A	3205	Monitor/Setting Item 4	H'00000000 to H'0000001E (0 to 30) Note: Same as for Monitor/Setting Item 1.	
120C	3206	Monitor/Setting Item 5	H'00000000 to H'0000001E (0 to 30) Note: Same as for Monitor/Setting Item 1.	

Address		Parameter name	Setting (monitor) value	Level
Four-byte mode	Two-byte mode			
1300	3300	Startup Operation	H'00000000 (0): Continue control at final SP H'00000001 (1): RESET H'00000002 (2): RUN H'00000003 (3): Manual* ¹	Initial setting
1302	3301	SP Tracking	H'00000000 (0): OFF H'00000001 (1): ON	Advanced function setting
1304	3302	PID Set Automatic Selection Data	H'00000000 (0): PV H'00000001 (1): DV H'00000002 (2): SP	
1306	3303	PID Set Automatic Selection Hysteresis	H'0000000A to H'0000270F (0.10 to 99.99)	
1308	3304	PV Dead Band	H'00000000 to H'0000270F (0 to 9999)	
130A	3305	Cold Junction Compensation Method	H'00000000 (0): OFF H'00000001 (1): ON	
1312	3309	Integral/Derivative Time Unit	H'00000000 (0): 1 s H'00000001 (1): 0.1 s	
1314	330A	α	H'00000000 to H'00000064 (0.00 to 1.00)	
1318	330C	Manual Output Method	H'00000000 (0): HOLD H'00000001 (1): INIT	
131A	330D	Manual MV Initial Value	Standard control or close position-proportional control: H'FFFFFFCE to H'0000041A (-5.0 to 105.0) Heating and cooling control: H'FFFFFFBE6 to H'0000041A (-105.0 to 105.0)	
131E	330F	AT Calculated Gain	H'00000001 to H'00000064 (0.1 to 10.0)	
1320	3310	AT Hysteresis	H'00000001 to H'0000270F (0.1 to 999.9 for temperature input) H'00000001 to H'000003E7 (0.01 to 9.99 for analog input)	
1322	3311	Limit Cycle MV Amplitude	H'00000032 to H'000001F4 (5.0 to 50.0)	
1328	3314	Heater Burnout Latch	H'00000000 (0): OFF H'00000001 (1): ON	
132A	3315	Heater Burnout Hysteresis	H'00000001 to H'000001F4 (0.1 to 50.0)	
132C	3316	HS Alarm Latch	H'00000000 (0): OFF H'00000001 (1): ON	
132E	3317	HS Alarm Hysteresis	H'00000001 to H'000001F4 (0.1 to 50.0)	
1334	331A	Operation End Operation	H'00000000 (0): RESET H'00000001 (1): Continue control at final SP H'00000002 (2): Fixed SP mode* ²	
1338	331C	HB ON/OFF	H'00000000 (0): OFF H'00000001 (1): ON	Advanced function setting
133A	331D	Program End ON Time	H'00000000 to H'00000064 (0.0 to 10.0) H'FFFFFFF (-1): ON	
133C	331E	Integrated Alarm Assignment	H'00000000 to H'000000FF (0 to 255)	
1344	3322	RT	H'00000000 (0): OFF H'00000001 (1): ON Note: Valid only with temperature input.	
1346	3323	HS Alarm Use	H'00000000 (0): OFF H'00000001 (1): ON	
1348	3324	LBA Detection Time	H'00000000 to H'0000270F (0 to 9999)	
134A	3325	LBA Level	H'00000001 to H'0000270F (0.1 to 999.9 for temperature input) (0.01 to 99.99 for analog input)	
134C	3326	LBA Band	H'00000000 to H'0000270F (0.0 to 999.9 for temperature input) (0.00 to 99.99 for analog input)	

*1 Selection is not possible when ON/OFF control is set.

*2 Selection is not possible if the Reset Operation parameter is set to fixed SP operation.

Address		Parameter name	Setting (monitor) value	Level
Four-byte mode	Two-byte mode			
1350	3328	Alarm SP Selection	H'00000000 (0): Set point during SP ramp H'00000001 (1): Set point	Advanced function setting
1356	332B	Manual MV Limit Enable	H'00000000 (0): OFF H'00000001 (1): ON	
1358	332C	Direct Setting of Position Proportional MV	H'00000000 (0): OFF H'00000001 (1): ON	
135A	332D	PV Rate of Change Calculation Period	H'00000001 to H'000003E7 (1 to 999)	
135C	332E	Heating/Cooling Tuning Method	H'00000000 (0): Same as heating control. H'00000001 (1): Linear H'00000002 (2): Air cooling H'00000003 (3): Water cooling	
136A	3335	LCT Cooling Output Minimum ON Time	H'00000001 to H'0000000A (0.1 to 1.0)	
136C	3336	Standby Time Unit	H'00000000 (0): Hours, minutes H'00000001 (1): Days, hours	
1370	3338	All PID AT Upper Limit SP	SP lower limit to SP upper limit	Initial setting

Address		Parameter name	Setting (monitor) value	Level
4 bytes	2 bytes			
1500	3500	PID 1 Proportional Band	H'00000001 to H'0000270F (0.1 to 999.9)	PID Setting
1502	3501	PID 1 Integral Time	Standard, heating/cooling, or close position-proportional control: H'00000000 to H'0000270F (0 to 9999: Integral/derivative time unit is 1 s.) (0.0 to 999.9: Integral/derivative time unit is 0.1 s.) Floating position-proportional control: H'00000001 to H'0000270F (1 to 9999: Integral/derivative time unit is 1 s.) (0.1 to 999.9: Integral/derivative time unit is 0.1 s.)	
1504	3502	PID 1 Derivative Time	H'00000000 to H'0000270F	
1506	3503	PID 1 MV Upper Limit	Standard control or close position-proportional control: MV lower limit + 0.1 to H'0000041A (MV lower limit + 0.1 to 105.0) Heating/cooling control: H'00000000 to H'0000041A (0.0 to 105.0)	
1508	3504	PID 1 MV Lower Limit	Standard control or close position-proportional control: H'FFFFFFCE to MV upper limit – 0.1 (–5.0 to MV upper limit – 0.1) Heating/cooling control: H'FFFFFFBE6 to H'00000000 (–105.0 to 0.0)	
150A	3505	PID 1 Automatic Selection Range Upper Limit	Temperature input: H'FFFFFF831 to H'0000270F (–1999 to 9999) Analog input: H'FFFFFFCE to H'0000041A (–5.0 to 105.0)	
150E	3507	PID 1 LBA Detection Time	H'00000000 to H'0000270F (0 to 9999)	
1510	3508	PID 1 Proportional Band (Cooling)	H'00000001 to H'0000270F	
1512	3509	PID 1 Integral Time (Cooling)	H'00000000 to H'0000270F (0 to 9999: Integral/derivative time unit is 1 s.) (0.0 to 999.9: Integral/derivative time unit is 0.1 s.)	
1514	350A	PID 1 Derivative Time (Cooling)	H'00000000 to H'0000270F (0 to 9999: Integral/derivative time unit is 1 s.) (0.0 to 999.9: Integral/derivative time unit is 0.1 s.)	
1516	350B	PID 1 Dead Band	Temperature input: H'FFFFFF831 to H'0000270F (–1999 to 999.9) Analog input: H'FFFFFF831 to H'0000270F (–199.9 to 999.9)	
1518	350C	PID 1 Manual Reset Value	H'00000000 to H'000003E8 (0.0 to 100.0)	
1520	3510	PID 2 Proportional Band	Temperature input: H'00000001 to H'0000270F (0.1 to 999.9) Analog input: H'00000001 to H'0000270F (0.1 to 999.9)	
		to		
1538	351C	PID 2 Manual Reset Value	H'00000000 to H'0000270F (0 to 9999)	
1540	3520	PID 3 Proportional Band	Temperature input: H'00000001 to H'0000270F (0.1 to 999.9) Analog input: H'00000001 to H'0000270F (0.1 to 999.9)	
		to		
1558	352C	PID 3 Manual Reset Value	H'00000000 to H'0000270F (0 to 9999)	
1560	3530	PID 4 Proportional Band	Temperature input: H'00000001 to H'0000270F (0.1 to 999.9) Analog input: H'00000001 to H'0000270F (0.1 to 999.9)	
		to		
1578	353C	PID 4 Manual Reset Value	H'00000000 to H'0000270F (0 to 9999)	
1580	3540	PID 5 Proportional Band	Temperature input: H'00000001 to H'0000270F (0.1 to 999.9) Analog input: H'00000001 to H'0000270F (0.1 to 999.9)	
		to		
1598	354C	PID 5 Manual Reset Value	H'00000000 to H'0000270F (0 to 9999)	
15A0	3550	PID 6 Proportional Band	Temperature input: H'00000001 to H'0000270F (0.1 to 999.9) Analog input: H'00000001 to H'0000270F (0.1 to 999.9)	
		to		
15B8	355C	PID 6 Manual Reset Value	H'00000000 to H'0000270F (0 to 9999)	
15C0	3560	PID 7 Proportional Band	Temperature input: H'00000001 to H'0000270F (0.1 to 999.9) Analog input: H'00000001 to H'0000270F (0.1 to 999.9)	
		to		
15D8	356C	PID 7 Manual Reset Value	H'00000000 to H'0000270F (0 to 9999)	

Address		Parameter name	Setting (monitor) value	Level
4 bytes	2 bytes			
15E0	3570	PID 8 Proportional Band	Temperature input: H'00000001 to H'0000270F (0.1 to 999.9) Analog input: H'00000001 to H'0000270F (0.1 to 999.9)	PID Setting
		to		
15F8	357C	PID 8 Manual Reset Value	H'00000000 to H'0000270F (0 to 9999)	

Address		Parameter name	Setting (monitor) value	Level
4 bytes	2 bytes			
1900	3900	Segment 0 Type* ¹	H'00000000 (0): Ramp H'00000001 (1): Soak H'00000002 (2): Step	Program setting
1902	3901	Segment 0 SP* ¹	SP lower limit to SP upper limit	
1904	3902	Segment 0 Slope* ¹	H'00000000 to H'0000270F (0 to 9999)	
1906	3903	Segment 0 Time* ¹	H'00000000 to H'00009959 (0.00 to 99.59) (hours, minutes) H'00000000 to H'00009959 (0.00 to 99.59) (minutes, seconds)	
1908	3904	Segment 1 Type* ¹	Same as for segment 0.	
	to	to		
1910	3908	Segment 2 Type* ¹		
	to	to		
1918	390C	Segment 3 Type* ¹		
	to	to		
1920	3910	Segment 4 Type* ¹		
	to	to		
1928	3914	Segment 5 Type* ¹		
	to	to		
1930	3918	Segment 6 Type* ¹		
	to	to		
1938	391C	Segment 7 Type* ¹		
	to	to		
1940	3920	Segment 8 Type* ¹		
	to	to		
1948	3924	Segment 9 Type* ¹		
	to	to		
1950	3928	Segment 10 Type* ¹		
	to	to		
1958	392C	Segment 11 Type* ¹		
	to	to		
1960	3930	Segment 12 Type* ¹		
	to	to		
1968	3934	Segment 13 Type* ¹		
	to	to		
1970	3938	Segment 14 Type* ¹		
	to	to		
1978	393C	Segment 15 Type* ¹		
	to	to		
1980	3940	Segment 16 Type* ¹		
	to	to		
1988	3944	Segment 17 Type* ¹		
	to	to		

*¹ These parameters apply to the program that is currently being executed.
In reset status, they apply to the program specified with the Program No. parameter.

Address		Parameter name	Setting (monitor) value	Level
4 bytes	2 bytes			
1990	3948	Segment 18 Type ^{*1}		Program setting
	to	to		
1998	394C	Segment 19 Type ^{*1}		
	to	to		
19A0	3950	Segment 20 Type ^{*1}		
	to	to		
19A8	3954	Segment 21 Type ^{*1}		
	to	to		
19B0	3958	Segment 22 Type ^{*1}		
	to	to		
19B8	395C	Segment 23 Type ^{*1}		
	to	to		
19C0	3960	Segment 24 Type ^{*1}		
	to	to		
19C8	3964	Segment 25 Type ^{*1}		
	to	to		
19D0	3968	Segment 26 Type ^{*1}		
	to	to		
19D8	396C	Segment 27 Type ^{*1}		
	to	to		
19E0	3970	Segment 28 Type ^{*1}		
	to	to		
19E8	3974	Segment 29 Type ^{*1}		
	to	to		
19F0	3978	Segment 30 Type ^{*1}		
	to	to		
19F8	397C	Segment 31 Type ^{*1}		
	to	to		

*1 These parameters apply to the program that is currently being executed.
In reset status, they apply to the program specified with the Program No. parameter.

5-2 Status

The status data for Modbus is the same as that for CompoWay/F. Refer to page 4-11.

6

Programless Communications

This section describes programless communications for the E5□C-T.

6-1	Programless Communications	6-3
6-1-1	Introduction	6-3
6-1-2	Features	6-3
6-1-3	Operation for Programless Communications	6-4
6-1-4	Timing of Turning Power ON and OFF	6-4
6-1-5	Connectable PLCs	6-5
6-2	E5□C-T Controller Setup	6-6
6-2-1	Protocol Setting	6-6
6-2-2	Communications Unit No. and Communications Baud Rate	6-7
6-2-3	Send Data Wait Time	6-7
6-2-4	Highest Communications Unit No.	6-7
6-2-5	Areas and First Address of Linked Data	6-8
6-2-6	Receive Data Wait Time	6-10
6-2-7	Communications Node Number	6-10
6-2-8	Upload Settings and Download Settings	6-11
6-2-9	Copying Parameter Settings	6-15
6-2-10	Communications Writing	6-18
6-2-11	Communications Monitor Parameter	6-19
6-3	Controlling Programless Communications	6-20
6-3-1	Controlling Programless Communications with the Request Flag	6-20
6-3-2	Response Flag	6-21
6-3-3	Range of Operation for Programless Communications	6-22
6-3-4	Operation Command Codes	6-22
6-3-5	Confirming Operation of Programless Communications	6-22
6-3-6	Write Mode	6-22
6-3-7	Troubleshooting	6-23
6-4	Connecting to CP-series PLCs	6-24
6-4-1	Configuration and Procedure	6-24
6-4-2	Switch Settings and Wiring	6-25
6-4-3	PLC Setup	6-25
6-4-4	E5□C-T Controller Setup	6-28
6-4-5	Checking Operation	6-30

6-5	Connecting to CJ-series PLCs	6-35
6-5-1	Configuration and Procedure	6-35
6-5-2	Switch Settings and Wiring	6-36
6-5-3	PLC Setup	6-36
6-5-4	E5□C-T Controller Setup	6-39
6-5-5	Checking Operation	6-39
6-6	Connecting to MELSEC Q-series PLCs	6-40
6-6-1	Configuration and Procedure	6-40
6-6-2	Wiring	6-41
6-6-3	PLC Setup	6-41
6-6-4	E5□C-T Controller Setup	6-46
6-6-5	Checking Operation	6-47

6-1 Programless Communications

6-1-1 Introduction

With programless communications you can read and write E5□C-T parameters or start and reset the E5□C-T from a Programmable Controller (PLC). Communications with the PLC are performed automatically by the E5□C-T, so there is no need to program communications.

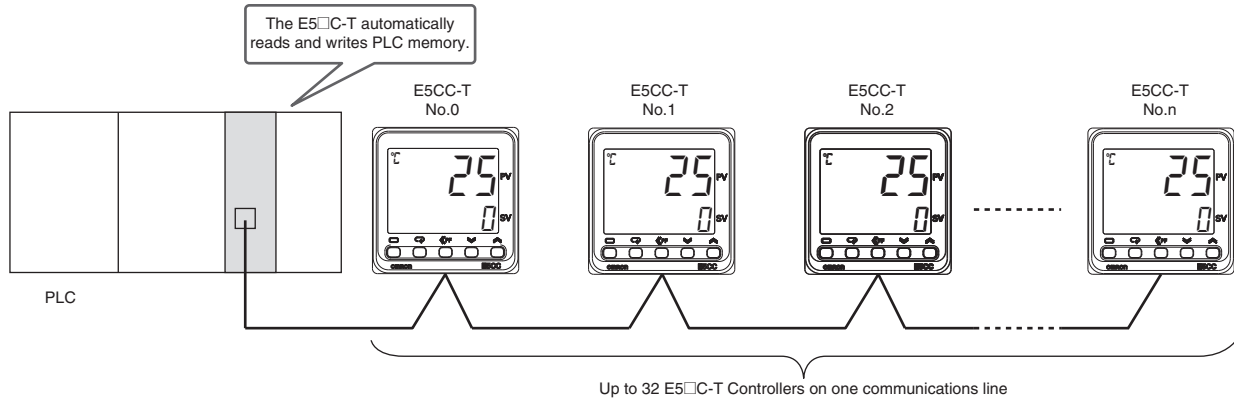

6-1-2 Features

- You can connect to an OMRON CS/CJ-series or CP-series PLC or to a Mitsubishi Q-series or L-series PLC.
- Up to 23 E5□C-T parameters can be assigned for reading and up to 43 E5□C-T parameters can be assigned for writing in PLC memory. Each E5□C-T Controller is allocated 70 words of PLC memory. (A total of 2,240 words are allocated if 32 E5□C-T Controllers are connected.)
- You can set the PLC memory area and addresses to use for programless communications.
- You can copy settings between E5□C-T Controllers to greatly reduce setup work and setting mistakes.

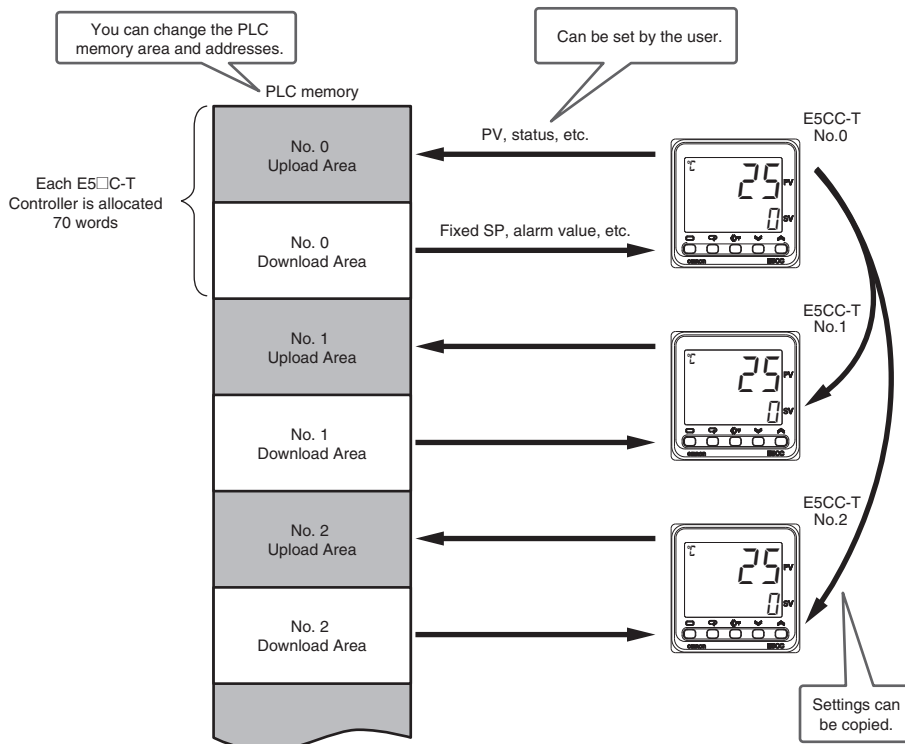

6-1-3 Operation for Programless Communications

Programless communications are performed in the following order of communications unit numbers.

0 (master) → 1 → 2 → ... → Highest communications unit number → 0 → 1...

The master (the Controller with communications unit number 0) starts programless communications approximately five seconds after the power supply to it is turned ON. (Communications are not performed until the power supply to the master is turned ON.) When the master starts communications, the slaves (the Controllers with a communications unit number other than 0) also start communications. After communications have started, they will continue for the remaining E5□C-T Controllers even if one or more of them (including the master) stop. However, the communications cycle will increase while waiting for communications from the stopped E5□C-T Controllers.

6-1-4 Timing of Turning Power ON and OFF

● Turning ON Power

Turn ON the power supply to the E5□C-T Controllers either after the PLC or at the same time as the PLC. The following may occur if the power supply is turned ON to the PLC after programless communications have started.

- The PLC may detect a communications error.
- The Response Flag may change to \overline{E} once at startup.

● Turning OFF Power to Mitsubishi PLCs

To turn OFF the power supply while communications with the PLC are active, change the E5□C-T Controller to the initial setting level first, and then turn OFF the power supply. If you turn OFF the power supply to an E5□C-T Controller during programless communications, the PLC may detect a communications error.

● Restarting only the E5□C-T Controllers

Use the following procedure to restart the E5□C-T Controllers.

- 1** Change all of the E5□C-T Controllers to the initial setting level.
- 2** Cycle the power supply in order to the slaves (the Controllers with a communications unit number other than 0) and then to the master (the Controller with a communications unit number of 0), or change the slaves and then the master back to the operation level.

Note: If the above procedure is not followed and the PLC detects an error, clear the error from the program in the PLC.

6-1-5 Connectable PLCs

The PLCs that can be connected are given below.

SYSMAC CS/CJ-series and CP-series PLCs

Name	Model number	Communications ports	
		Port 1	Port 2
Serial Communications Units	CJ1W-SCU21-V1 CJ1W-SCU22	RS-232C	RS-232C
	CJ1W-SCU41-V1 CJ1W-SCU42	RS-422A/485 (Cannot be used.)	
	CS1W-SCU21-V1	RS-232C	
Serial Communications Board	CS1W-SCB21-V1	RS-232C	RS-232C
	CS1W-SCB41-V1		RS-422A/485 (Cannot be used.)
CPU Units	CS1/CJ1M CPU Units	RS-232C	
	CJ2 CPU Units	RS-232C or option board slot	
	CP-series CPU Units	RS-232C	RS-485*2 or option board slot
Serial Communications Option Boards *1	CP1W-CIF11 CP1W-CIF12	RS-422A/485	

Note: The CJ1W-CIF11 RS-422A Converter is required to use an RS-232C port.

*1 The Option Board is mounted in the option board slot that is given above.

*2 An RS-485 port is built into only the CP1E-N□□S1.

MELSEC Q-series and L-series PLCs

Name	Model number	Communications ports	
		Port 1	Port 2
Q Corresponding Serial Communication Module	QJ71C24N	RS-232C (Cannot be used.)	RS-422/485
	QJ71C24N-R4	RS-422/485	
L Corresponding Serial Communication Module	LJ71C24	RS-232C (Cannot be used.)	

6-2 E5□C-T Controller Setup

The parameters that are used for programless communications are shown with a gray background in the following diagram. All of these parameters are displayed if you set the Protocol Setting parameter to *FINS* or *MCP4*. (Some of the parameters are always displayed.) The parameters in the communications setting level are described first, followed by those in the adjustment level.

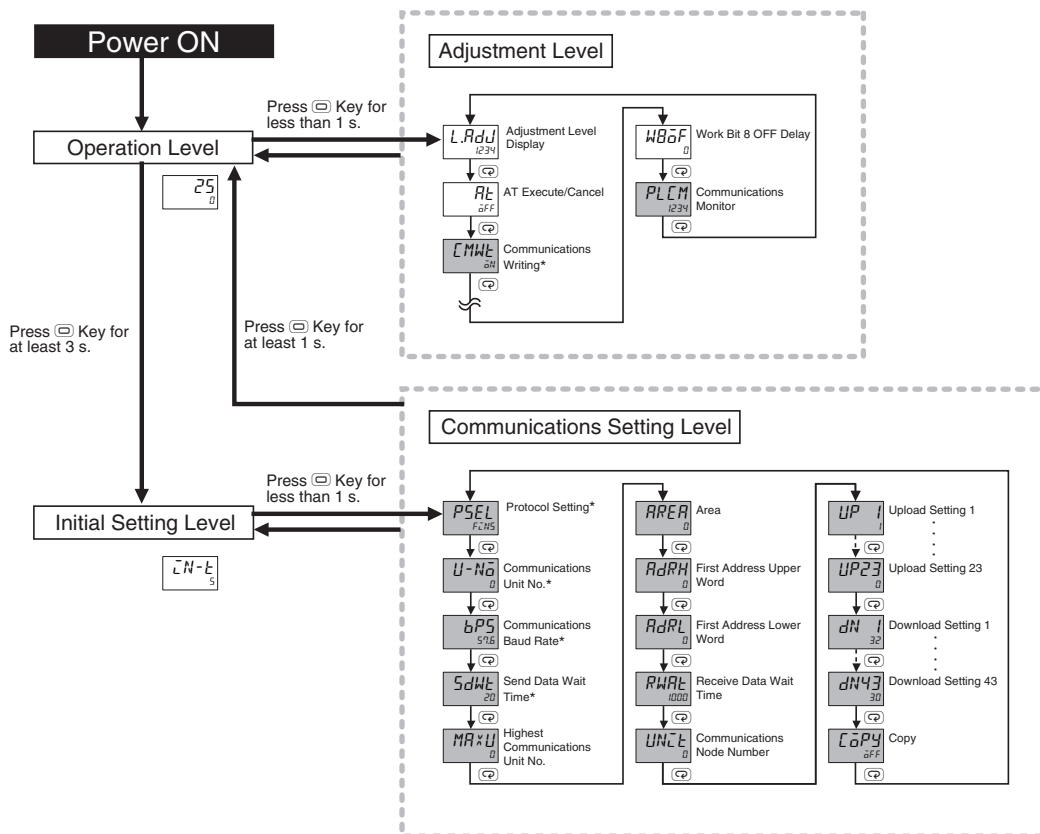

* These parameters are displayed regardless of the setting of the Protocol Setting parameter.
 Note: The Communications Data Length, Communications Stop Bits, and Communications Parity parameters in the communications setting level are not displayed.

6-2-1 Protocol Setting

Set the Protocol Setting parameter to *FINS* to connect to an OMRON PLC and to *MCP4* to connect to a Mitsubishi PLC. Set the Protocol Setting parameter to *EMP* to use component communications. Refer to 6-1-5 *Connectable PLCs* for lists of the PLCs that can be connected. Refer to 7-1 *Component Communications* for information on component communications.

Communications Setting Level
 Display condition: None

Parameter name	Displayed characters	Setting range	Default
Protocol Setting	PSEL	EWF: CompoWay/F Mod: ModbusRTU EMP: Component communications FINS: Host Link (FINS) MCP4: MC protocol (format 4)	EWF

6-2-2 Communications Unit No. and Communications Baud Rate

Always assign communications unit numbers in order starting from 0. Do not skip any numbers. Communications unit number 0 is for the master. The numbers from 1 on are for the slaves. We recommend a communications baud rate setting of 57.6. Set the same communications baud rate for all of the E5□C-T Controllers and the PLC. (Setting the PLC is required only for programless communications.)

Communications Setting Level

Display condition: None

Parameter name	Displayed characters	Setting range	Default
Communications Unit No.	$U-N\bar{0}$	0: Master 1 to 31: Slaves	1
Communications Baud Rate	$bP5$	9.6: 9600bps 19.2: 19200bps 38.4: 38400bps 57.6: 57600bps	9.6

6-2-3 Send Data Wait Time

This is the time that the E5□C-T will wait from the time that it receives a response from the PLC (or, for component communications, from an E5□C-T slave) until it sends the next command. Increase the set value of this parameter if the command is sent too soon to allow the PLC (or, for component communications, the E5□C-T slave) to receive it.

Communications Setting Level

Display condition: None

Parameter name	Displayed characters	Setting range	Default
Send Data Wait Time	$SdWt$	0 to 99 ms	20 ms

6-2-4 Highest Communications Unit No.

Set the Highest Communications Unit No. parameter to the highest communications unit number that is actually set on the connected E5□C-T Controllers.

Make sure that setting of the Highest Communications Unit No. parameter agrees with the unit numbers of the E5□C-T Controllers that are actually connected.

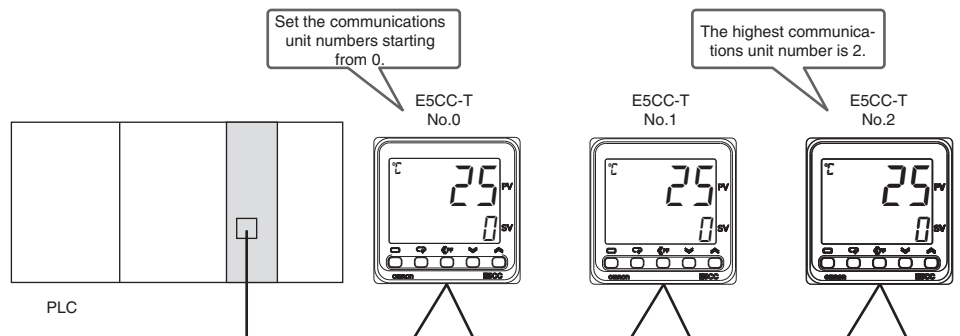

Communications Setting Level

Display condition: The Protocol Setting parameter must be set to F_{LNS} or $M_{L P 4}$

The Protocol Setting parameter must be set to L_{MP} and the Communications Unit No. parameter must be set to 0 (master).

Parameter name	Displayed characters	Setting range	Default
Highest Communications Unit No.	$M_{R \times U}$	0 to 99	0

6-2-5 Areas and First Address of Linked Data

Two areas are used in PLC memory by the E5□C-T, an upload area and a download area. The upload area is used to monitor the process value, status, and other information from the E5□C-T. The download area is used to write the fixed SP, segment SPs, segment times, alarm values, and other values to the E5□C-T.

	Address	Data in PLC memory	
Upload Area	XXXX	Response Flag	This flag indicates the completion of processing for the Request Flag.
	+1	Communications Status	The status that is given at this address is used in the PLC to check the operation of programless communications.
	+2	Monitor Value 1	Information from the E5□C-T, such as the PV or status, is set at these addresses. The parameters that are actually used are set in the upload settings.
	+3	Monitor Value 2	
		...	
+24	Monitor Value 23		
Download Area	+25	Request Flag	This flag is used to control programless communications.
	+26	Operation Command Code	The operation command that corresponds to the code is sent.
	+27	Set Value 1	The set values at these addresses are written to the E5□C-T, such as to the fixed SP, segment SPs, segment times, and alarm values. The parameters that are actually used are set in the download settings.
	+28	Set Value 2	
		...	
+69	Set Value 43		

The Response Flag, Communications Status, Request Flag, and Operation Command Code all have special functions that cannot be changed. Refer to the following sections for application methods.

Request Flag: 6-3-1 *Controlling Programless Communications with the Request Flag*

Response Flag: 6-3-2 *Response Flag*

Operation Command Code: 6-3-4 *Operation Command Codes*

Communications Status: 6-3-5 *Confirming Operation of Programless Communications*

The portion of PLC memory to use is set with the Area, First Address Upper Word, and First Address Lower Word parameters.

Note: If more than one E5□C-T Controller is connected to the same communications line, set the starting address to the same value for all of them. The E5□C-T Controller with communications unit number 0 will use the words that start from the specified starting address, the E5□C-T Controller with unit number 1 will use the words that start from the specified starting address plus 70 words, and the E5□C-T Controller with unit number 2 will use the words that start from the specified starting address plus 140 words

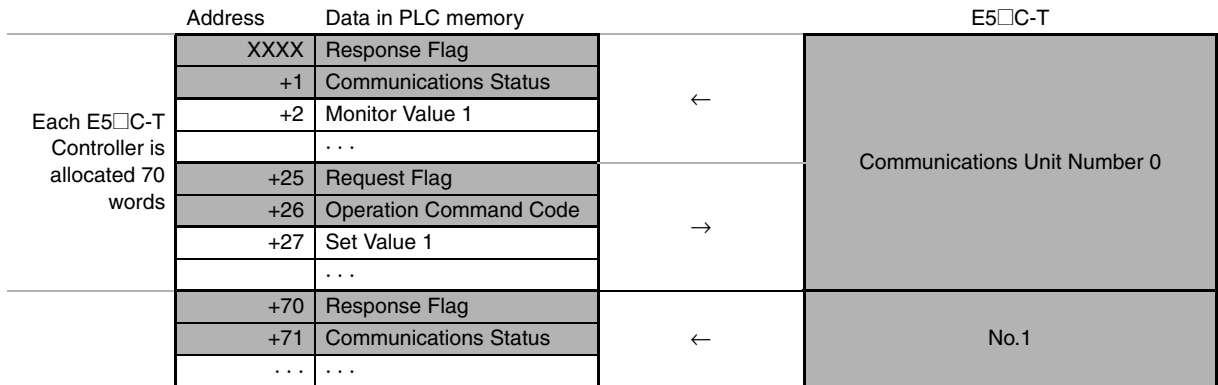

Communications Setting Level

Display condition: The Protocol Setting parameter must be set to *F2NS* or *MCP4*.

Parameter name	Displayed characters	Setting range	Default
Area	<i>AREA</i>	0: DM (D data registers) 1: EM0 (W link registers) 2: EM1 (R file registers) 3: EM2 (ZR file registers) 4: EM3 5: EM4 6: EM5 7: EM6 8: EM7 9: EM8 10: EM9 11: EMA 12: EMB 13: EMC 14: EMD 15: EME 16: EMF 17: EM10 18: EM11 19: EM12 20: EM13 21: EM14 22: EM15 23: EM16 24: EM17 25: EM18 Information in parentheses is applicable when the Protocol Setting parameter is set to <i>MCP4</i> . Also, all set values of 4 and higher specify D data registers.	0
First Address Upper Word	<i>ADRH</i>	0 to 99	0
First Address Lower Word	<i>ADRL</i>	0 to 9999	0

Note: 1 The First Address Upper Word and First Address Lower Word parameters together specify the first address.

Example: If the first address is 123456, set the First Address Upper Word parameter to 12 and the First Address Lower Word parameter to 3456.

- 2 Set the same first address in all of the E5□C-T Controllers (e.g., set the same value as the value that is set for the E5□C-T with communications unit number 0).

Applicable PLC Memory Addresses

Protocol setting	Area	Applicable address range
Host Link (FINS)	DM	0 to 32767
	EM0 to EM18	
MC protocol (format 4)	D data registers	0 to 12287
	W link registers	0 to 8191 (1FFF hex)
	R file registers	0 to 32767
	ZR file registers	0 to 999999 (F423F hex)

Note: The address ranges depend on the type of PLC. Refer to the manual for your PLC and set the first address within an applicable range. The last address that is used by the E5□C-T is calculated as follows:

$$\text{Last address} = \text{First address} + (\text{highest communication unit number} + 1) \times 70 - 1$$

Example: The following example is for three E5□C-T Controllers (highest communications unit number = 2). The first address is set to 100.

$$\text{Last address} = 100 + 3 \times 70 - 1 = 309$$

6-2-6 Receive Data Wait Time

The receive data wait time is the time that the E5□C-T waits for a response from the PLC (or, for component communications, from an E5□C-T slave). You can normally use the default setting.

If you change the receive data wait time, the time at which programless communications start will change after the power supply is cycled. Use the following formula to calculate the start time.

$$\text{Start time} = \text{Approx. } 1 \text{ s} + \text{Receive data wait time} \times 4$$

Example: For the default setting of 1,000 ms, the start time is approximately 5 s.

Communications Setting Level

Display condition: The Protocol Setting parameter must be set to *FINS* or *MCP4*.

The Protocol Setting parameter must be set to *MP* and the Communications Unit No. parameter must be set to 0 (master).

Parameter name	Displayed characters	Setting range	Default
Receive Data Wait Time	<i>RWRL</i>	100 to 9999 ms	1000 ms

6-2-7 Communications Node Number

Set the communications node number to the Host Link unit number for an OMRON PLC and to the station number for a Mitsubishi PLC.

You can normally use the default setting.

Communications Setting Level

Display condition: The Protocol Setting parameter must be set to *FINS* or *MCP4*.

Parameter name	Displayed characters	Setting range	Default
Communications Node Number	<i>UNLE</i>	0 to 99	0

6-2-8 Upload Settings and Download Settings

There are 23 upload settings and 43 download settings.

Communications Setting Level

Display condition: The Protocol Setting parameter must be set to *FLNS* or *MCP4*.

Parameter name	Displayed characters	Setting range		Default
Upload Setting 1	UP 1	0 to 179	1	Communications Monitor
Upload Setting 2	UP 2		2	Status (Upper Word)
Upload Setting 3	UP 3		3	Status (Lower Word)
Upload Setting 4	UP 4		4	Status 2 (Upper Word)
Upload Setting 5	UP 5		6	Decimal Point Monitor
Upload Setting 6	UP 6		7	Process Value
Upload Setting 7	UP 7		8	Present SP
Upload Setting 8	UP 8		9	Heater Current 1 Value Monitor
Upload Setting 9	UP 9		13	MV Monitor (Heating)
Upload Setting 10	UP 10		16	PID Set No. Monitor
Upload Setting 11	UP 11		17	Program No. Monitor
Upload Setting 12	UP 12		18	Segment No. Monitor
Upload Setting 13	UP 13		19	Remaining Standby Time Monitor
Upload Setting 14	UP 14		20	Elapsed Program Time Monitor
Upload Setting 15	UP 15		21	Remaining Program Time Monitor
Upload Setting 16	UP 16		22	Elapsed Segment Time Monitor
Upload Setting 17	UP 17		23	Remaining Segment Time Monitor
Upload Setting 18	UP 18		24	Program Execution Repetitions Monitor
Upload Setting 19	UP 19		0	Nothing assigned.
Upload Setting 20	UP20		0	Nothing assigned.
Upload Setting 21	UP21		0	Nothing assigned.
Upload Setting 22	UP22		0	Nothing assigned.
Upload Setting 23	UP23		0	Nothing assigned.
Download Setting 1	DN 1	30 to 179	32	Fixed SP
Download Setting 2	DN 2		42	PID 1 Proportional Band
Download Setting 3	DN 3		43	PID 1 Integral Time
Download Setting 4	DN 4		44	PID 1 Derivative Time
Download Setting 5	DN 5		78	Program 0 Alarm Value 1
Download Setting 6	DN 6		79	Program 0 Alarm Upper Limit 1
Download Setting 7	DN 7		80	Program 0 Alarm Lower Limit 1
Download Setting 8	DN 8		81	Program 0 Alarm Value 2
Download Setting 9	DN 9		82	Program 0 Alarm Upper Limit 2
Download Setting 10	DN 10		83	Program 0 Alarm Lower Limit 2
Download Setting 11	DN 11		36	Heater Burnout Detection 1
Download Setting 12	DN 12		40	Process Value Input Shift
Download Setting 13	DN 13		33	Wait Band
Download Setting 14	DN 14		34	Standby Time
Download Setting 15	DN 15		35	Program SP Shift Value

Parameter name	Displayed characters	Setting range	Default	
Download Setting 16	<i>dN16</i>	30 to 179	101	Program 0 Segment 0 SP
Download Setting 17	<i>dN17</i>		103	Program 0 Segment 0 Time
Download Setting 18	<i>dN18</i>		106	Program 0 Segment 1 SP
Download Setting 19	<i>dN19</i>		108	Program 0 Segment 1 Time
Download Setting 20	<i>dN20</i>		111	Program 0 Segment 2 SP
Download Setting 21	<i>dN21</i>		113	Program 0 Segment 2 Time
Download Setting 22	<i>dN22</i>		116	Program 0 Segment 3 SP
Download Setting 23	<i>dN23</i>		118	Program 0 Segment 3 Time
Download Setting 24	<i>dN24</i>		121	Program 0 Segment 4 SP
Download Setting 25	<i>dN25</i>		123	Program 0 Segment 4 Time
Download Setting 26	<i>dN26</i>		126	Program 0 Segment 5 SP
Download Setting 27	<i>dN27</i>		128	Program 0 Segment 5 Time
Download Setting 28	<i>dN28</i>		131	Program 0 Segment 6 SP
Download Setting 29	<i>dN29</i>		133	Program 0 Segment 6 Time
Download Setting 30	<i>dN30</i>		136	Program 0 Segment 7 SP
Download Setting 31	<i>dN31</i>		138	Program 0 Segment 7 Time
Download Setting 32	<i>dN32</i>		141	Program 0 Segment 8 SP
Download Setting 33	<i>dN33</i>		143	Program 0 Segment 8 Time
Download Setting 34	<i>dN34</i>		146	Program 0 Segment 9 SP
Download Setting 35	<i>dN35</i>		148	Program 0 Segment 9 Time
Download Setting 36	<i>dN36</i>		30	Nothing assigned.
Download Setting 37	<i>dN37</i>		30	Nothing assigned.
Download Setting 38	<i>dN38</i>		30	Nothing assigned.
Download Setting 39	<i>dN39</i>		30	Nothing assigned.
Download Setting 40	<i>dN40</i>		30	Nothing assigned.
Download Setting 41	<i>dN41</i>		30	Nothing assigned.
Download Setting 42	<i>dN42</i>		30	Nothing assigned.
Download Setting 43	<i>dN43</i>		30	Nothing assigned.

● Example of Changing a Setting:

To set the Program 0 Alarm Value 3 parameter for Download Setting 11, you would change the set value from 36 (Heater Burnout Detection 1) to 84 (Program 0 Alarm Value 3).

You can use the settings in the following table for the upload settings and download settings.

Set value		Set value		
Upload settings (Cannot be used for download settings.)	0	Nothing assigned.	Upload or Download Settings	
	1	Communications Monitor		
	2	Status (Upper Word)		
	3	Status (Lower Word)		
	4	Status 2 (Upper Word)		
	5	Status 2 (Lower Word)		
	6	Decimal Point Monitor		
	7	Process Value		
	8	Present SP		
	9	Heater Current 1 Value Monitor		
	10	Heater Current 2 Value Monitor		
	11	Leakage Current 1 Monitor		
	12	Leakage Current 2 Monitor		
	13	MV Monitor (Heating)		
	14	MV Monitor (Cooling)		
	15	Valve Opening Monitor		
	16	PID Set No. Monitor		
	17	Program No. Monitor		
	18	Segment No. Monitor		
	19	Remaining Standby Time Monitor		
	20	Elapsed Program Time Monitor		
	21	Remaining Program Time Monitor		
	22	Elapsed Segment Time Monitor		
	23	Remaining Segment Time Monitor		
	24	Program Repetitions Monitor		
	25	Nothing assigned.		
		
	29	Nothing assigned.		
	Upload or Download Settings	30		Nothing assigned.
31		Manual MV	52	MV at Reset
32		Fixed SP	53	MV at PV Error
33		Wait Band	54	PID 1 MV Upper Limit
34		Standby Time	55	PID 1 MV Lower Limit
35		Program SP Shift Value	56	MV Change Rate Limit
36		Heater Burnout Detection 1	57	Position Proportional Dead Band
37		Heater Burnout Detection 2	58	Open/Close Hysteresis
38		HS Alarm 1	59	Extraction of Square Root Low-cut Point
39		HS Alarm 2	60	Work Bit 1 ON Delay
40		Process Value Input Shift	61	Work Bit 1 OFF Delay
41		PV Slope Coefficient	62	Work Bit 2 ON Delay
42		PID 1 Proportional Band	63	Work Bit 2 OFF Delay
43		PID 1 Integral Time	64	Work Bit 3 ON Delay
44		PID 1 Derivative Time	65	Work Bit 3 OFF Delay
45		PID 1 Proportional Band (Cooling)	66	Work Bit 4 ON Delay
46		PID 1 Integral Time (Cooling)	67	Work Bit 4 OFF Delay
47		PID 1 Derivative Time (Cooling)	68	Work Bit 5 ON Delay
48		PID 1 Dead Band	69	Work Bit 5 OFF Delay
49		PID 1 Manual Reset Value	70	Work Bit 6 ON Delay
50		Hysteresis (Heating)	71	Work Bit 6 OFF Delay
			72	Work Bit 7 ON Delay
			73	Work Bit 7 OFF Delay
			74	Work Bit 8 ON Delay
			75	Work Bit 8 OFF Delay
			76	Program 0 No. of Segments Used
		77	Nothing assigned.	
		78	Program 0 Alarm Value 1	
		79	Program 0 Alarm Upper Limit 1	
		80	Program 0 Alarm Lower Limit 1	
		81	Program 0 Alarm Value 2	
		82	Program 0 Alarm Upper Limit 2	
		83	Program 0 Alarm Lower Limit 2	
		84	Program 0 Alarm Value 3	
		85	Program 0 Alarm Upper Limit 3	
		86	Program 0 Alarm Lower Limit 3	
		87	Program 0 Alarm Value 4	
		88	Program 0 Alarm Upper Limit 4	
		89	Program 0 Alarm Lower Limit 4	
		90	Program 0 Program Repetitions	
		91	Nothing assigned.	
		92	Program 0 Time Signal 1 Set Segment	
		93	Program 0 Time Signal 1 ON Time	
		94	Program 0 Time Signal 1 OFF Time	
		95	Program 0 Time Signal 2 Set Segment	
		96	Program 0 Time Signal 2 ON Time	
		97	Program 0 Time Signal 2 OFF Time	
		98	Nothing assigned.	
		99	Nothing assigned.	

	Set value	
Upload or Download Settings	100	Program 0 Segment 0 Type
	101	Program 0 Segment 0 SP
	102	Program 0 Segment 0 Slope
	103	Program 0 Segment 0 Time
	104	Nothing assigned.
	105	Program 0 Segment 1 Type
	106	Program 0 Segment 1 SP
	107	Program 0 Segment 1 Slope
	108	Program 0 Segment 1 Time
	109	Nothing assigned.
	110	Program 0 Segment 2 Type
	111	Program 0 Segment 2 SP
	112	Program 0 Segment 2 Slope
	113	Program 0 Segment 2 Time
	114	Nothing assigned.
	115	Program 0 Segment 3 Type
	116	Program 0 Segment 3 SP
	117	Program 0 Segment 3 Slope
	118	Program 0 Segment 3 Time
119	Nothing assigned.	
120	Program 0 Segment 4 Type	
121	Program 0 Segment 4 SP	
122	Program 0 Segment 4 Slope	
123	Program 0 Segment 4 Time	
124	Nothing assigned.	
125	Program 0 Segment 5 Type	
126	Program 0 Segment 5 SP	
127	Program 0 Segment 5 Slope	
128	Program 0 Segment 5 Time	
129	Nothing assigned.	
130	Program 0 Segment 6 Type	
131	Program 0 Segment 6 SP	
132	Program 0 Segment 6 Slope	
133	Program 0 Segment 6 Time	
134	Nothing assigned.	
135	Program 0 Segment 7 Type	
136	Program 0 Segment 7 SP	
137	Program 0 Segment 7 Slope	
138	Program 0 Segment 7 Time	
139	Nothing assigned.	

	Set value	
Upload or Download Settings	140	Program 0 Segment 8 Type
	141	Program 0 Segment 8 SP
	142	Program 0 Segment 8 Slope
	143	Program 0 Segment 8 Time
	144	Nothing assigned.
	145	Program 0 Segment 9 Type
	146	Program 0 Segment 9 SP
	147	Program 0 Segment 9 Slope
	148	Program 0 Segment 9 Time
	149	Nothing assigned.
	150	Program 0 Segment 10 Type
	151	Program 0 Segment 10 SP
	152	Program 0 Segment 10 Slope
	153	Program 0 Segment 10 Time
	154	Nothing assigned.
	155	Program 0 Segment 11 Type
	156	Program 0 Segment 11 SP
	157	Program 0 Segment 11 Slope
	158	Program 0 Segment 11 Time
159	Nothing assigned.	
160	Program 0 Segment 12 Type	
161	Program 0 Segment 12 SP	
162	Program 0 Segment 12 Slope	
163	Program 0 Segment 12 Time	
164	Nothing assigned.	
165	Program 0 Segment 13 Type	
166	Program 0 Segment 13 SP	
167	Program 0 Segment 13 Slope	
168	Program 0 Segment 13 Time	
169	Nothing assigned.	
170	Program 0 Segment 14 Type	
171	Program 0 Segment 14 SP	
172	Program 0 Segment 14 Slope	
173	Program 0 Segment 14 Time	
174	Nothing assigned.	
175	Program 0 Segment 15 Type	
176	Program 0 Segment 15 SP	
177	Program 0 Segment 15 Slope	
178	Program 0 Segment 15 Time	
179	Nothing assigned.	

Note: 1 If nothing is assigned for an upload setting, the corresponding address in the upload area will contain 0. If nothing is assigned for a download setting, nothing will be done in the download area.

- 2 If the same value is set for more than one download setting, only the download setting with the lower number will be valid. The other download setting will be treated as if nothing was assigned. All upload settings are valid even if the same value is set more than once.

6-2-9 Copying Parameter Settings

You can copy the settings of all parameters except for the Communications Unit No. parameter from the master (i.e., the Controller with communications unit number 0) to one or more of the slaves (i.e., the Controllers with communications unit numbers other than 0). Copying parameters is possible only between Controllers with the same model number. You also cannot copy parameter settings to a Controller with a version that is older than the version of the master. All of the slaves are automatically reset after the copying operation is completed. Make sure that the system will not be adversely affected before you copy parameter settings.

Case in which copying is possible	The model numbers and versions are the same. Example: Copying data from the E5CC-TRX3ASM-002 (V1.0) to the E5CC-TRX3ASM-002 (V1.0)
Cases in which copying is not possible	The model numbers are different. Example: Copying data from the E5CC-TRX3ASM-002 to the E5CC-TQX3ASM-002
	The versions are different. Example: Copying data from the E5CC-TRX3ASM-002 (V1.0) to the E5CC-TRX3ASM-002 (V1.1)

Communications Setting Level

Display condition: The Protocol Setting parameter must be set to *EMP*, *FNS*, or *MPY* and the Communications Unit No. parameter must be set to 0 (master).

Parameter name	Displayed characters	Setting range	Default
Copy	<i>COPY</i>	<i>OFF</i> (Copying failed: <i>EO**</i>) <i>ALL</i> 1 to 31	<i>OFF</i>

Copying Procedure Starting from the Initial Status

- (1) Connect the master and slaves with RS-485 connections and turn ON the power supply.
- (2) Set the Communications Unit No. parameters of the slaves in order starting from 1 and then return to the operation level.
- (3) Set all of the parameters in the master except for those in the communications setting level.
- (4) Change the master to the communications setting level and change the communications settings as given below.

Change the Protocol Setting parameter, set the Communications Unit No. parameter to 0, set the Communications Baud Rate parameter to 57.6, set the Send Data Wait Time parameter to 1, and set the Highest Communications Unit No. parameter to the highest communications unit number that is set.

Change the other parameters in the communications setting level as required.

Do not return to the operation level while you are changing the parameter settings. If you mistakenly return to the communications setting level, return the Communications Baud Rate parameter to 9.6, return to the operation level, and then set the Communications Baud Rate parameter again.

(5) *COPY* and execute the copy operation.

If you select *ALL*, the parameters settings will be copied to all of the slaves. If you select a number, the parameters settings will be copied to the slave with the selected communications unit number.

Set value	Description
<i>OFF</i> (<i>EQ**</i>)	Copying is not in progress. The display will automatically return to <i>OFF</i> when the copy operation is completed normally. If the copy operation fails, <i>**</i> will be displayed instead of <i>OFF</i> . The asterisks will be replaced with the communications unit number of the slave where copying failed. Example: If copying failed at the slave with communications unit number 2, <i>EQ02</i> will be displayed.
<i>ALL</i>	The parameter settings are copied to the slaves starting with the slave with communications unit number 1 and continuing on to the slave with the communications unit number that is set in the Highest Communications Unit No. parameter. When copying is started, the PV display on the slave will change to <i>COPY</i> . The copying operation is completed when all of the slaves are reset.
1 to 31	The parameter settings are copied to the slave with the specified communications unit number, and then all of the slaves are automatically reset.

Note: 1 You cannot cancel copying once the copying operation has been started. Even if you change the set value during the copying operation, the current processing will be continued.

- 2 If copying fails, the copying operation will be aborted and the parameter settings will not be copied to the remaining slaves.
- 3 The following parameters are not copied.
 - Auto/Manual
 - RUN/RESET
 - SP Mode
 - Hold
 - Manual MV

For a Mitsubishi PLC, the ERR. indicator on the Serial Communications Module will light during the copying process, but this does not indicate an error. The ERR. indicator will go out when the PLC is restarted.

Refer to 6-4-4 *E5□C-T Controller Setup* for specific copying procedures.

Troubleshooting

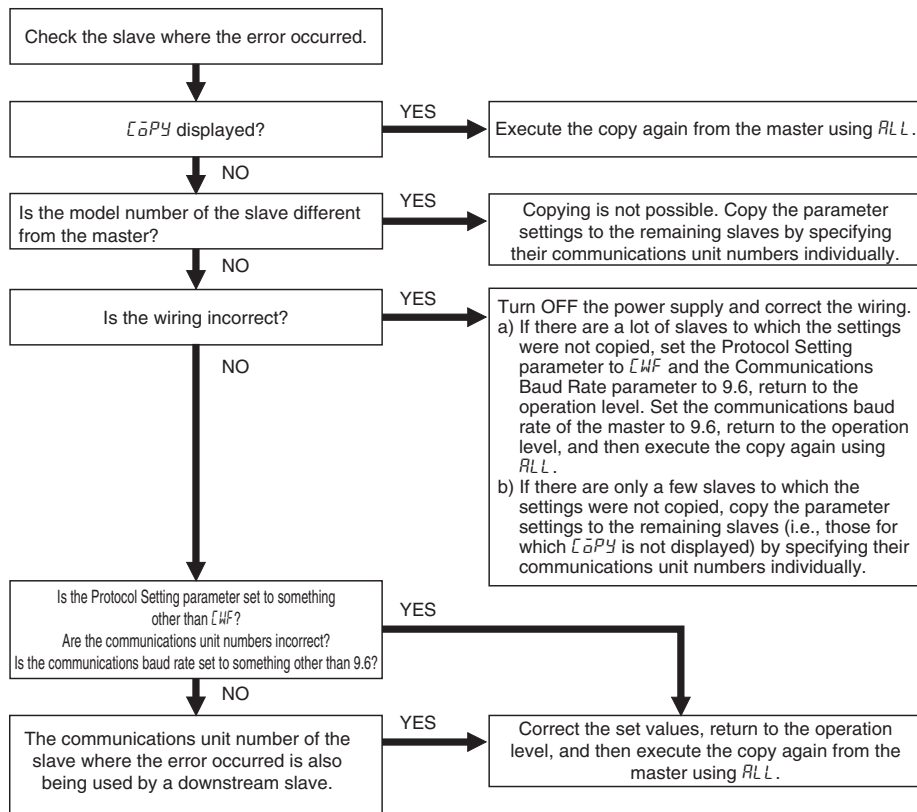

- Note: 1 If you cycle the power supply to the E5□C-T Controllers after the error occurs, perform procedure “a” given above.
- 2 If you cannot solve the problem with the above flowchart or if the situation becomes too confusing, cycle the power supply to all of the E5□C-T Controllers and then perform procedure “a” given above to copy the parameter settings to all of the slaves.

Copying Procedure When Replacing a Controller

- **Replacing a Slave (i.e., a Controller with a Communications Unit Number Other Than 0)**

- (1) Replace the E5□C-T, wire it, and then turn ON the power supply.
- (2) Change all of the E5□C-T Controllers to the initial setting level and stop programless communications.
- (3) Set the Communications Unit No. parameter and Communications Baud Rate parameter (57.6) in the new E5□C-T Controller and then return to the operation level.
- (4) Copy the parameter set values from the master to the new E5□C-T Controller by specifying the number of the Controller.
- (5) Return all of the slaves and the master in order to the operation level. This completes the replacement.

- **Replacing the Master (i.e., the Controller with a Communications Unit Number of 0)**

To copy the parameter settings, one of the slaves will function as the master, which means that the No. 0 Upload Area and the No. 1 Upload Area will temporarily change in PLC memory. Turn OFF the power supply to the PLC or otherwise make sure that the system will not be adversely affected before you perform the following procedure.

- (1) Perform steps 1 and 2 in the above procedure.
- (2) Record the communications unit number and communications baud rate of the slave with communications unit number 1, and then temporarily change the communications unit number to 0 (master). Do not return to the operation level after you change the communications unit number.
- (3) Set the Communications Unit No. parameter and the Communications Baud Rate parameter of the new E5□C-T to the values that you recorded, and then change to the operation level.
- (4) Copy the parameter settings from the temporary master, specifying the communications unit number of the new E5□C-T.
- (5) Reverse the communications unit numbers of the temporary master and the new E5□C-T.
- (6) Return all of the slaves and the master in order to the operation level. This completes the replacement.

6-2-10 Communications Writing

Writing can be enabled and disabled from the PLC. The Communications Writing parameter is normally left ON (enabled). However, if it is necessary to change set values from the display section of the E5□C-T in an emergency, temporarily change the setting to OFF (disabled). If you disable communications when writing is being performed from the PLC, an error will occur in the PLC. (An error code will be set in the Response Flag in PLC memory.) If you cycle the power supply to the E5□C-T or move to the initial setting level and then go back to the operation level, the Communications Writing parameter will automatically change to ON.

6-2-11 Communications Monitor Parameter

This parameter displays the communications cycle time of the E5□C-T. If communications with the PLC are not possible, *ERR* is displayed and then the cycle time is displayed again when communications are restored.

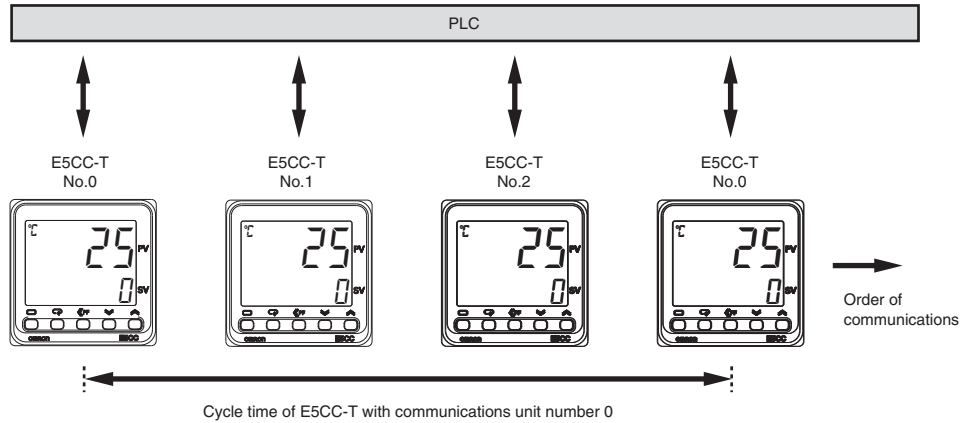

Adjustment Level

Display condition: The Protocol Setting parameter must be set to *FN5* or *MP4*.

Parameter name	Displayed characters	Monitor range*	Default
Communications Monitor	<i>PLEM</i>	Normal operation: 0 to 9999 ms. If 9,999 ms is exceeded, <i>ERR</i> is displayed. Error: <i>ERR</i>	---

Note: If this parameter is monitored in PLC memory, the cycle time is given as 0 to FFFF hex (0 to 65,535 decimal). An error is indicated by FFFF hex.

6-3 Controlling Programless Communications

The section describes the methods that are used to control programless communications from the PLC.

6-3-1 Controlling Programless Communications with the Request Flag

There are the following three ways to control programless communications. The Request Flag in PLC memory is used to change the control method.

1. Updating Monitor Values (Disable Writing Request)

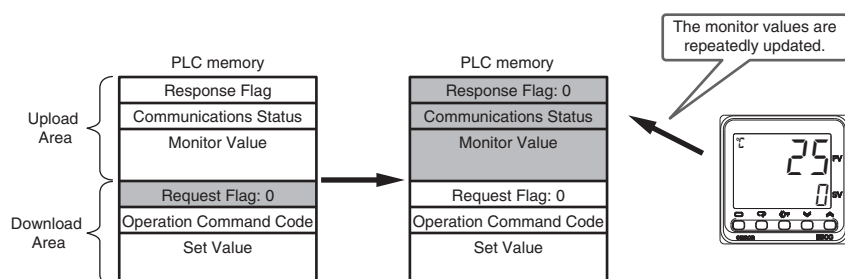

If you set the Request Flag to 0, the Response Flag will change to 0 and the monitor values will be updated.

2. Writing Set Values and Updating Monitor Values (Enable Writing Request)

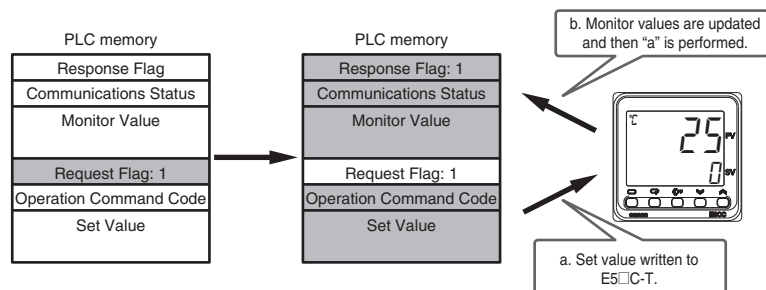

If you set the Request Flag to 1, the set values will be written to the E5□C-T and then the operation command will be written to the E5□C-T. Finally the Response Flag will change to 1 and the monitor values will be updated. The operation command is processed only the first time, but the set values are written each time. Therefore, you cannot change the parameters that are specified for download settings at the E5□C-T. To change parameters that are specified for download settings at the E5□C-T, refer to 6-2-10 *Communications Writing*.

3. Initializing the Download Area

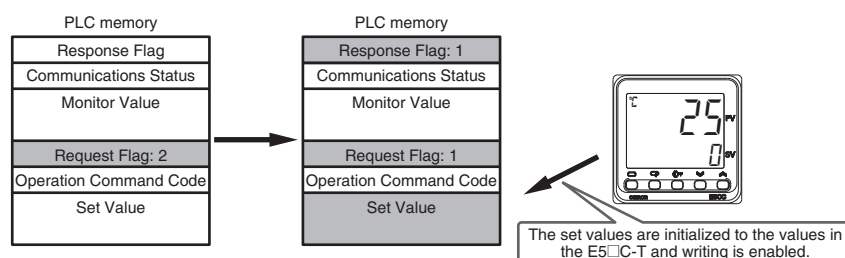

If you set the Request Flag to 2, the set values in the download area will be initialized to the values from the E5□C-T and then the Request Flag and Response Flag will change to 1. Finally, the operation described above for control method 2 is performed.

6-3-2 Response Flag

The Response Flag changes as shown below for the values of the Request Flag.

Request Flag	Response Flag	
	Normal	Error
0: Disable Writing	0 *	EEEE
1: Enable Writing	1	EDD 1 to ED43 8000 or Operation Command Code
2: Initialize Download Areas	1	EEEE

* If a communications error prevents reading data for the Request Flag, the Response Flag will change to EEEE.

Response Flag at error	Cause of error
EEEE	There was no response or a communications error occurred when reading the download area.
EDD 1 to ED43 *1	<ul style="list-style-type: none"> The write data is out of the setting range. The Communications Writing parameter is set to OFF.
8000 (hex) or Operation Command Code *2	<ul style="list-style-type: none"> The operation command code is incorrect. The current status of the E5□C-T prevents it from acknowledging the operation command. The Communications Writing parameter is set to OFF.

*1 The Response Flag gives the number of the download setting where the error occurred. If more than one error occurs, the smallest number is given first. When the error is cleared, the next error number is given.

Example: If errors occur for download settings 10 and 12, the Response Flag will be ED 12.

*2 An OR of 8000 and the operation command code is given. If a setting range error occurs at the same time, indicating the operation command error will be given priority.

Example: If an error occurs for operation command code 1101, the Response Flag will be 9 10 1.

● Precautions for AT (Auto-tuning)

Do not change the set values in the download area from the start of auto-tuning until auto-tuning is completed or canceled. Programless communications cannot be used to change the set values of the E5□C-T after auto-tuning starts. Also, if the Request Flag is set to 1 (Enable Writing) at the completion of auto-tuning, the set values in the download area are initialized to the set values from the E5□C-T. This is to update the PID constants. (It occurs even if PID constants are not set in the download area.) To prevent initialization, change the Request Flag to 0 (Disable Writing) after auto-tuning starts. If you change the Request Flag to 1 (Enable Writing) after the completion of auto-tuning, the values in PLC memory will be written to the E5□C-T. If you change the Request Flag to 2 (Initialize Download Areas) after the completion of auto-tuning, the download area will be initialized with the set values from the E5□C-T.

6-3-3 Range of Operation for Programless Communications

Programless communications start operating after the power supply is turned ON or after the E5□C-T is reset. They stop operating when the initial setting level is entered.

Levels		Programless communications
Operation level, program setting level, adjustment level, PID setting level, manual control level, monitor/setting item level, and protect level	Setting area 0	Operates
Initial setting level, communications setting level, advanced function setting level, and calibration level	Setting area 1	Stops

6-3-4 Operation Command Codes

The following table gives the operation command codes that can be set. For details on operation commands, refer to *2-3-8 Operation Command*.

Operation command	Operation command code	Switch
RUN/RESET	0100	RUN
	0101	RESET
AT Execute/Cancel	030E	All PID 40% AT Execute
	030F	All PID 100% AT Execute
	0300	AT Cancel
	0301	100% AT Execute
	0302	40% AT Execute
Write Mode	0400	Backup Mode
	0401	RAM Write Mode
Save RAM Data	0500	Save RAM Data
Software Reset	0600	Software Reset
Auto/Manual	0900	Automatic Mode
	0901	Manual Mode
Alarm Latch Cancel	0C00	Alarm 1 Latch Cancel
	0C01	Alarm 2 Latch Cancel
	0C02	Alarm 3 Latch Cancel
	0C03	Heater Burnout Latch Cancel
	0C04	HS Alarm Latch Cancel
	0C05	Alarm 4 Latch Cancel
	0C0F	All Latch Cancel
SP Mode	0D00	Program SP Mode
	0D01	Fixed SP Mode
Invert Direct/Reverse Operation	0E00	Do Not Invert
	0E01	Invert
Hold	1300	Hold cleared.
	1301	Hold
Advance	1400	

6-3-5 Confirming Operation of Programless Communications

You can check the operation of programless communications in the Communications Status in the upload area.

The value of the Communications Status changes between 0 and 1 each time the upload area is updated.

6-3-6 Write Mode

The E5□C-T normally writes the set values to non-volatile memory (i.e., in Backup Mode). If you frequently change set values with programless communications, use an operation command to change to RAM Write Mode.

In RAM Write Mode, however, the set values will be restored to the values in non-volatile memory every time the power supply is cycled. If you need to maintain the current set values before the power supply is turned OFF, use an operation command to save them to RAM before the power supply turns OFF.

6-3-7 Troubleshooting

Possible problems that can occur with programless communications and corrective actions are given in the following table.

Status	Cause and corrective action	Page	
The Response Flag changes to $E0^{**}$.	The write value for the set value for download setting ** is out of range.	3-4 to 3-7	
	The Communications Writing parameter is set to OFF.	6-18	
The Response Flag changes to 8^{***} (hex) or 9^{***} (hex).	The operation command code is incorrect.	6-22	
	The current status of the E5□C-T prevents it from acknowledging the operation command.	2-18 to 2-20	
	The Communications Writing parameter is set to OFF.	6-18	
The Response Flag changes to $EEEE$.	The power supply to the E5□C-T Controllers was turned ON before the power supply to the PLC.	6-4	
	The PLC memory address is out of range.	6-8	
	There may be noise interference. Shield the communications line or attach terminating resistance to the end of the communications line.	6-25	
		6-36 6-41	
<ul style="list-style-type: none"> The communications indicator on the PLC flashes irregularly. The value of the Communications Monitor parameter in the E5□C-T is too long. 	The Highest Communications Unit No. parameter is not set to the highest communications unit number that is actually set.	6-7	
	<ul style="list-style-type: none"> Communications unit numbers are not set consecutively from 0 or the same communications unit number is set more than once. The setting of the Communications Baud Rate parameter is not the same for all E5□C-T Controllers. 	6-7	
	The E5□C-T was moved to the initial setting level (setting area 1).	6-22	
<ul style="list-style-type: none"> The communications indicator on the PLC is not lit. The Communications Monitor parameter in the E5□C-T is $E.ERR$. 	The power supply is not turned ON to the E5□C-T Controller with communications unit number 0.	6-4	
	The wiring is not correct.	6-25 6-36 6-41	
		The communications settings are not the same between the PLC and the E5□C-T.	6-25 6-36 6-41 6-28
		The E5□C-T was moved to the initial setting level (setting area 1).	6-22
	Check the cycle time of the PLC. If it is longer than the value set for the Receive Data Wait Time parameter, change the set value of this parameter so that it is longer than the cycle time.	6-10	
The ERR. indicator on the Serial Communications Module is lit (for a Mitsubishi PLC).	The power supply to the E5□C-T Controllers was not turned ON or OFF at the proper time.	6-4	

Note: For information on other problems, refer to *A-2 Troubleshooting*.

6-4 Connecting to CP-series PLCs

6-4-1 Configuration and Procedure

The following configuration is used as an example in giving the setup and application procedures for programless communications.

- All of the E5CC-T Controllers must be the same model. (Copying parameter settings is not possible if the models are different.)
- D0000 to D0209 are used in the PLC memory. The default E5CC-T parameter allocations are used.
- A commercially available USB2.0, A/B cable is used.

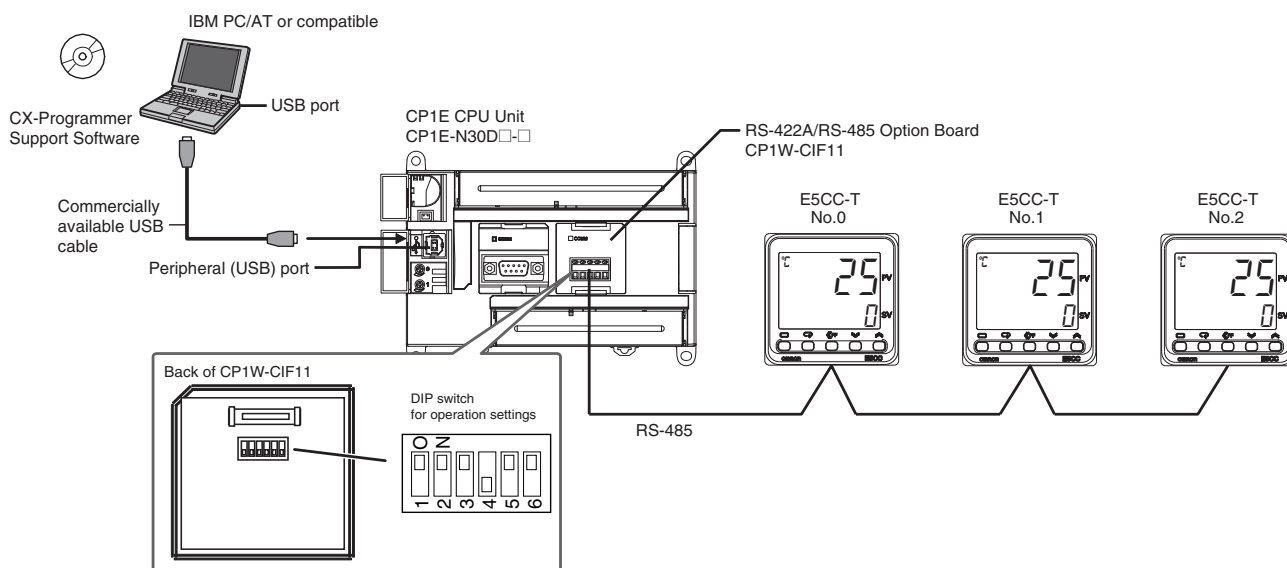

Note: Refer to the *CX-Programmer Operation Manual* (Cat. No. W446) for information on installing the CX-Programmer and USB driver.

The application procedure is given below.

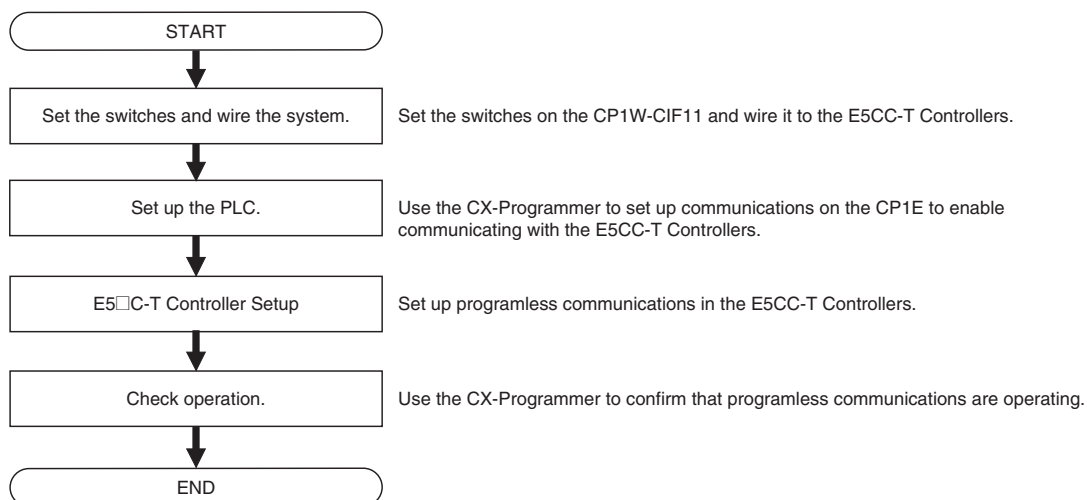

6-4-2 Switch Settings and Wiring

Before you attach the CP1W-CIF11 to the CP1E, turn OFF pin 4 on the DIP switch for operation settings on the back of the CP1W-CIF11 and turn ON the rest of the pins.

Pin	OFF	ON	Setting
1	No terminating resistance	Terminating resistance on both ends	Terminating resistance selection
2	4-wire	2-wire	2-wire or 4-wire selection
3	4-wire	2-wire	Same as above.
4	---	---	Not used.
5	RS control disabled. (Signal always received.)	RS control enabled.	RS control selection for RD
6	RS control disabled. (Signal always sent.)	RS control enabled.	RS control selection for SD

Wire the CP1W-CIF11 to the E5CC-T Controllers as shown below.

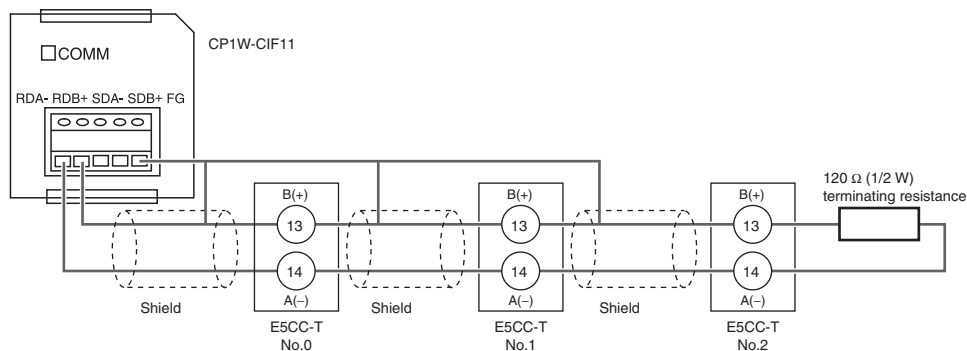

- Note: 1 The maximum transmission distance is 50 m for the CP1W-CIF11 and 500 m for the CP1W-CIF21.
 2 For wiring methods, refer to A-3-2 Recommended RS-422A/485 Wiring in the CP1E CPU Unit Hardware User's Manual (Cat. No. W479).

6-4-3 PLC Setup

Set up communications on the CP1E to enable communicating with the E5CC-T Controllers. PLC operation will stop and the power supply will be cycled during the setup procedure. Make sure that this will not create any problems in the controlled system.

● Connecting to the PLC

- (1) Connect the computer to the CP1E with a USB cable and then start the CX-Programmer.
- (2) Select **PLC – Auto Online – Direct Online** from the menu bar.

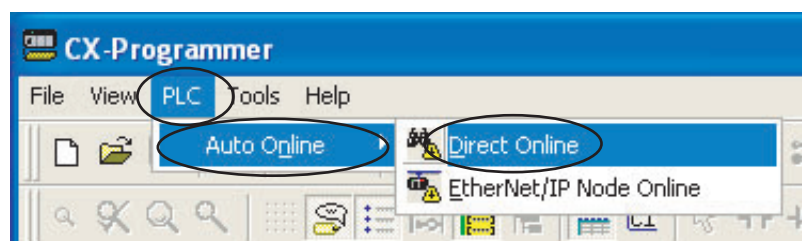

(3) Select the **USB connection** Check Box and click the **Connect** Button.

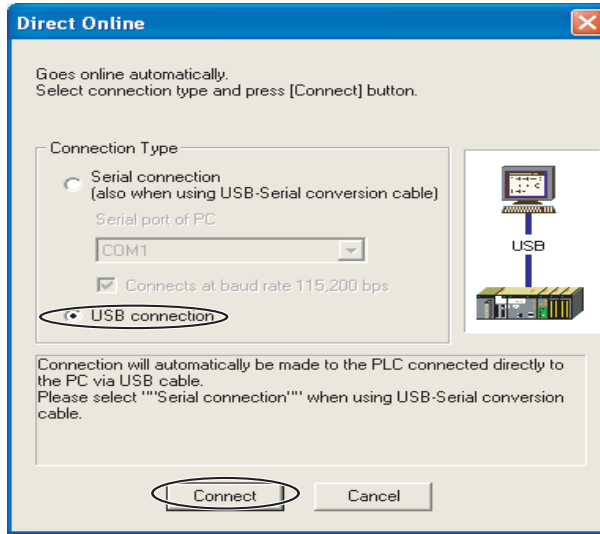

(4) Select the **Transfer IO table and Special Unit Setup** Check Box and click the **Yes** Button.

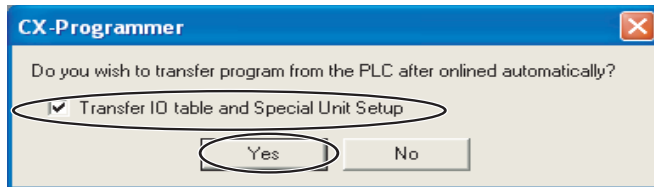

(5) After the data has been transferred, click the **OK** Button.

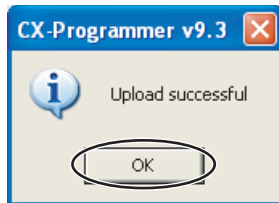

Communications Settings for the Serial Communications Option Board

- (1) The PLC operating mode must be changed to PROGRAM mode to enable changing the communications settings in the PLC Setup. Select *PLC – Operating Mode – Program* from the menu bar. A confirmation dialog box will be displayed. Click the Yes Button.

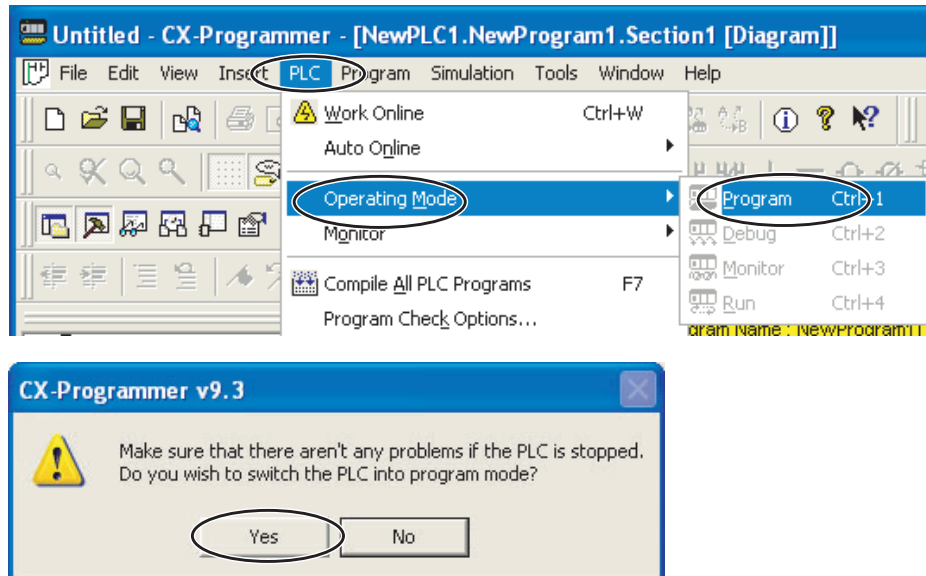

- (2) Double-click Settings. The PLC Setup Window will be displayed.

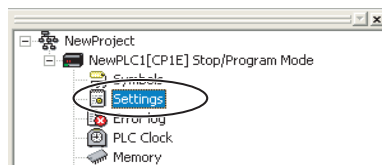

- (3) Click the Serial Option Port Tab, select the *Custom* Option, and set the baud rate to 57,600. Leave the other settings at their default values.

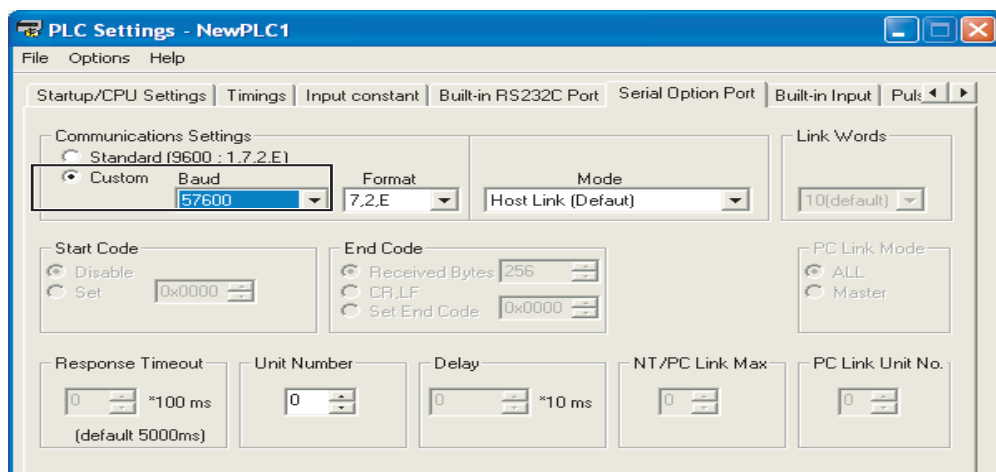

Note: If you change the unit number, refer to 6-2-7 Communications Node Number.

- (4) **Select *Options – Transfer to PLC*** from the menu bar in the window that is shown above. The settings will be transferred.
Close the window and cycle the power to the PLC. This completes the PLC setup procedure. You will use the CX-Programmer to check operation, so leave it online.

6-4-4 E5□C-T Controller Setup

This section describes the setup for programless communications. Refer to 6-2 *E5□C-T Controller Setup* for the procedure to display parameters. Here we will assume that all parameters other than those for communications have already been set. Make sure that all of the E5□C-T Controllers are the same model. The parameter settings cannot be copied if the models are different.

- (1) **Set the Communications Unit No. parameter ($U-N\bar{a}$) in the communications setting level to 1 for the No. 1 Controller (E5CC-T) and set it to 2 for the No. 2 Controller.**

The default communications unit number is 1, so the Communications Unit No. parameter for the No. 1 Controller does not need to be changed.

Always set the communications unit numbers of the slaves in order from 1.

To enable the changes to the settings, always return to the operation level.

- (2) **Change the parameter settings in the communications setting level of the No. 0 Controller to the values that are given below.**

Protocol Setting ($PSEL$): $FN5$ (Set $MP4$ for a Mitsubishi PLC.)

Communications Unit No. ($U-N\bar{a}$): 0

Communications Baud Rate (bPS): 57.6

Send Data Wait Time ($sdWT$): 1

Highest Communications Unit No. ($MRxU$): 2

Do not return to the operation level even after you finish making the settings.

Here we will assume that all parameters other than those for communications have already been set. If parameters other than those for communications need to be set, change them first and then change the communications settings last.

- (3) **Perform the following procedure to copy the parameter settings in the No. 0 Controller to the No. 1 and No. 2 Controllers.**

(a) **Display the $\bar{C}\bar{a}PY$ parameter in the communications setting level on the No. 0 Controller.**

(b) **Press the Up Key to select ALL and wait for three seconds. The completion of the copy operation must be confirmed, so do not move to any other levels or parameters. If you do change to any other levels or parameters, display the $\bar{C}\bar{a}PY$ parameter again.**

(c) **The PV displays on the No. 1 and No. 2 Controllers will change to $\bar{C}\bar{a}PY$ and then these Controllers will be reset.**

(d) **Confirm that the setting of the $\bar{C}\bar{a}PY$ parameter on the No. 0 Controller changes to $\bar{a}FF$ (i.e., copying completed), and then return the No. 0 Controller to the operation level.**

(e) **Programless communications should now be operating. Confirm that the COMM indicator on the CP1W-CIF11 is flashing.**

If you are using the CJ1W-SCU21-V1, the SD1 and RD1 indicators will flash. If you are using the QJ71C24N-R4, the SD and RD indicators for channel 1 (CH1) will flash.

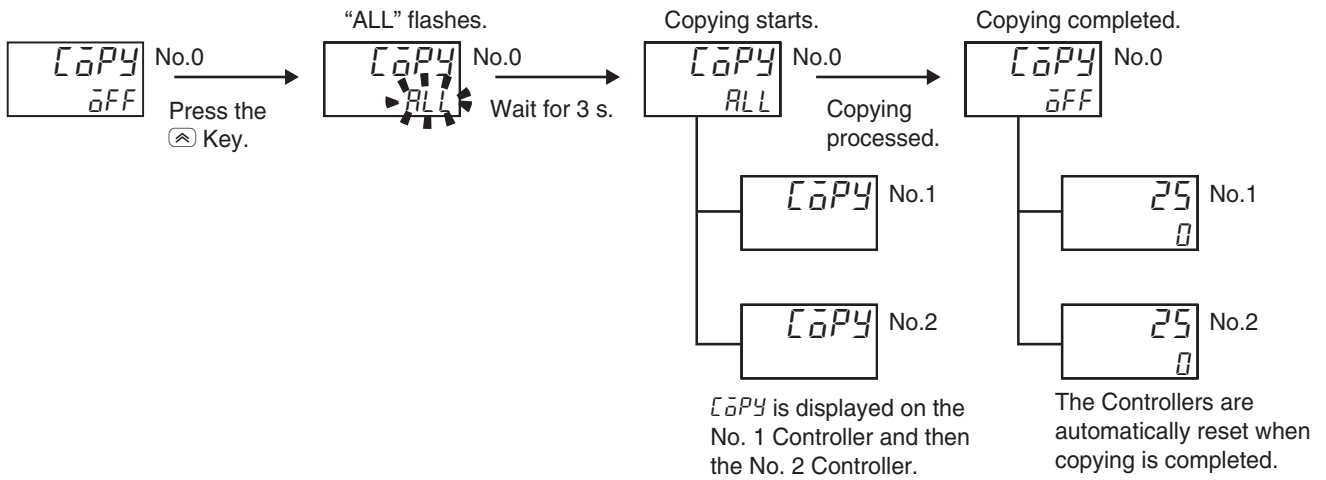

CP1W-CIF11

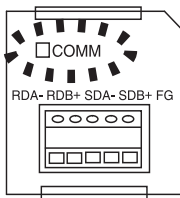

CJ1W-SCU21-V1

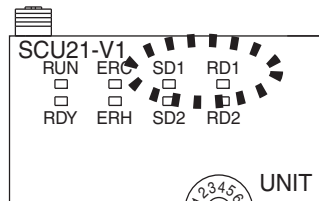

QJ71C24N-R4

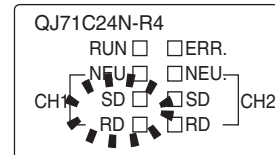

For a Mitsubishi PLC, the ERR. indicator on the Serial Communications Module will light during the copying process. Ignore it and check the operation. The ERR. indicator will go out when the PLC is restarted.

Note: Refer to 6-2-9 Copying Parameter Settings for details on the copying operation.

6-4-5 Checking Operation

The SP and RUN/RESET status of the E5□C-T Controllers will be changed to check operation. Make sure that this will not create any problems in the controlled system.

● Checking E5CC-T Monitor Values

- (1) **The PLC operating mode must be changed to PROGRAM mode to enable changing values in PLC memory.**

Perform step 1 in *Communications Settings for the Serial Communications Option Board* in 6-4-3 PLC Setup to move to PROGRAM mode.

- (2) **Double-click Memory. The PLC Memory Window will be displayed.**

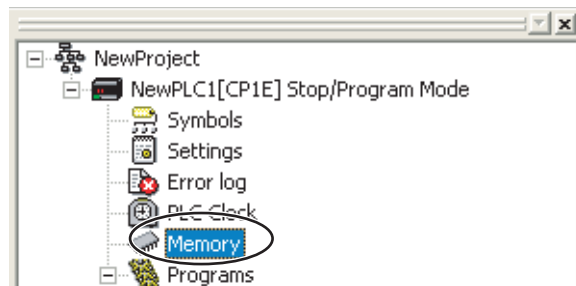

- (3) **We will monitor memory in the PLC Memory Window.**

Double-click **D** to select the DM Area in the left pane and then select **Online – Monitor** from the menu bar. The Monitor Memory Areas Dialog Box will be displayed. Click the **Monitor** Button.

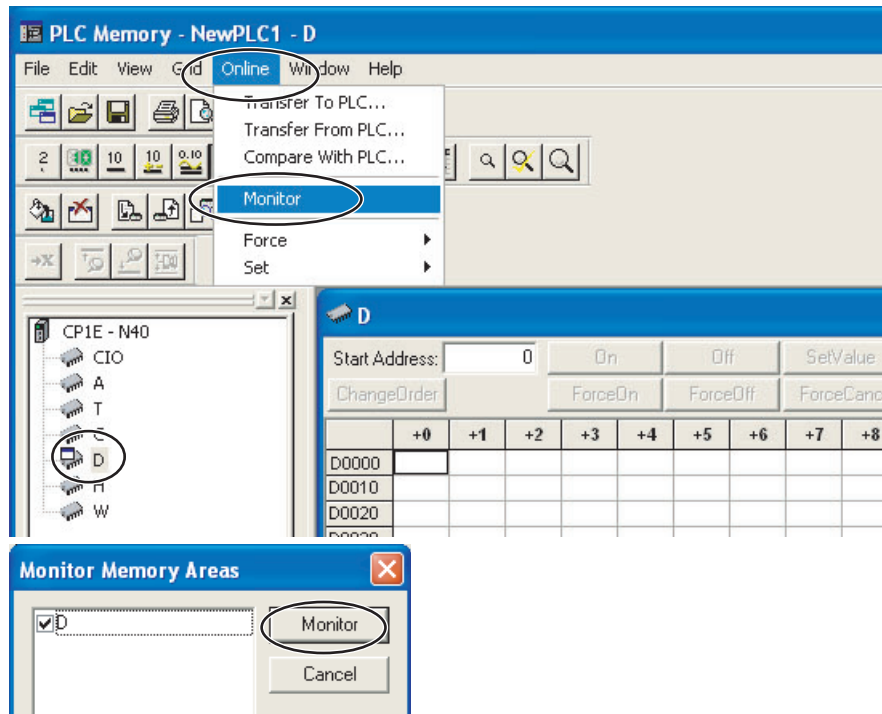

- (4) We will change the values that are displayed for PLC memory to signed decimal values.

Select **View – Display – Signed Decimal** from the menu bar. You can select **View – Display – Hexadecimal** to return the display to hexadecimal values.

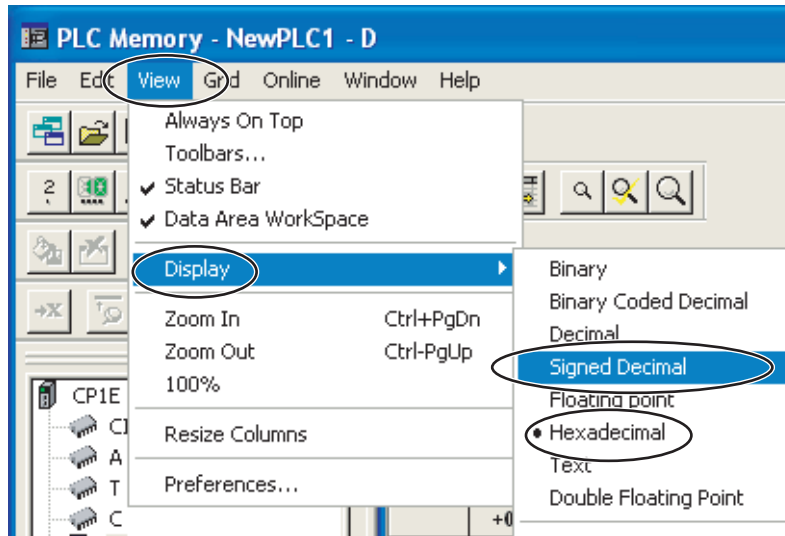

- (5) We will check the E5CC-T monitor values.

The area where monitor values are checked is called the upload area.

D0000 to D0024 is the upload area for the No. 0 Controller (E5CC-T), D0070 to D0094 is the upload area for the No. 1 Controller, and D0140 to D0164 is the upload area for the No. 2 Controller.

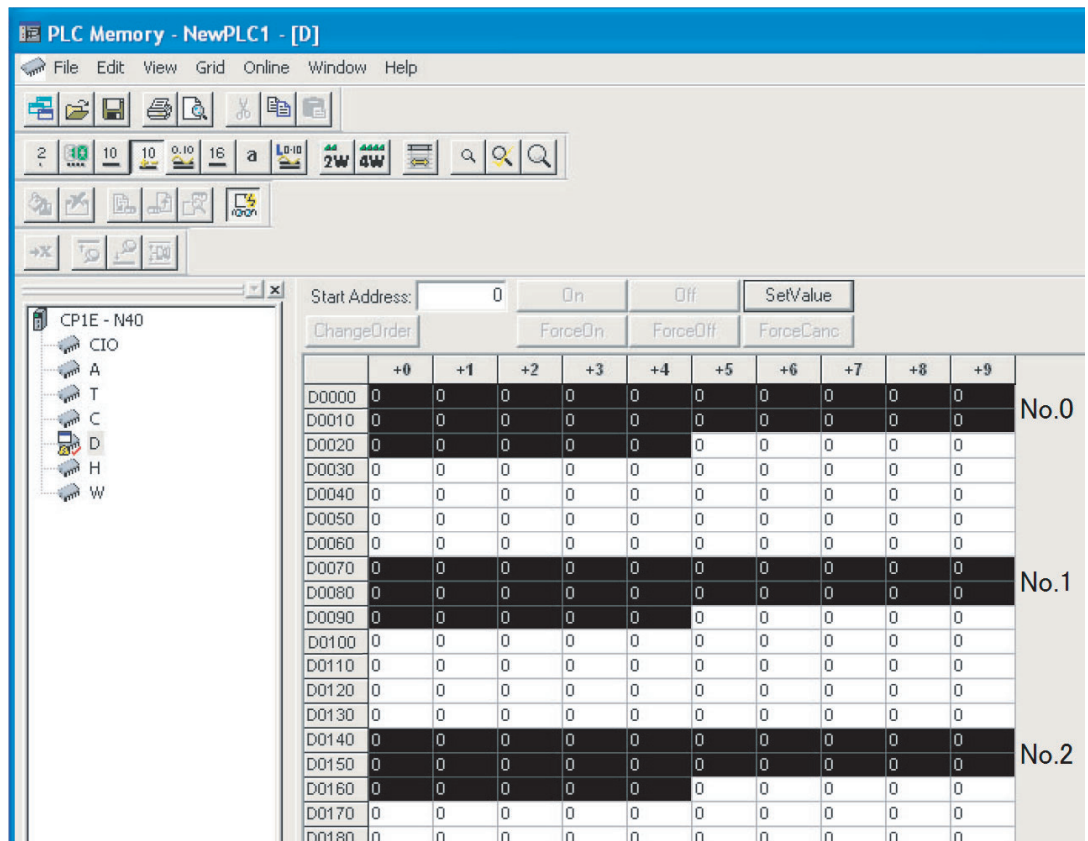

With the default settings, the following parameters are set for the upload areas. Check the values in the upload areas to see if they are the same as those that are given in the following table. (It is not necessary to check addresses for which “---” is given in the Value column.)

No.0	No.1	No.2	Parameter	Value
D0000	D0070	D0140	Response Flag (fixed)	0
D0001	D0071	D0141	Communications Status (fixed)	Alternates between 0 and 1.
D0002	D0072	D0142	Communications Monitor	---
D0003	D0073	D0143	Status (Upper Word)	---
D0004	D0074	D0144	Status (Lower Word)	---
D0005	D0075	D0145	Status 2 (Upper Word)	---
D0006	D0076	D0146	Decimal Point Monitor	---
D0007	D0077	D0147	Process Value	Process Value *
D0008	D0078	D0148	Present SP	---
D0009	D0079	D0149	Heater Current 1 Value Monitor	---
D0010	D0080	D0150	MV Monitor (Heating)	---
D0011	D0081	D0151	PID Set No. Monitor	---
D0012	D0082	D0152	Program No. Monitor	---
D0013	D0083	D0153	Segment No. Monitor	---
D0014	D0084	D0154	Remaining Standby Time Monitor	---
D0015	D0085	D0155	Elapsed Program Time Monitor	---
D0016	D0086	D0156	Remaining Program Time Monitor	---
D0017	D0087	D0157	Elapsed Segment Time Monitor	---
D0018	D0088	D0158	Remaining Segment Time Monitor	---
D0019	D0089	D0159	Program Execution Repetitions Monitor	---
...
D0024	D0094	D0164	Nothing assigned.	---

* If the default settings are used and a sensor is not connected, the PV display on the E5CC-T will show an input error (5.ERR) and the process value in the upload area will be 1320 (528 hex).

Changing E5CC-T Settings

- (1) We will check the area that is used to change E5CC-T set values.

The area that is used to change the set value is called the download area. D0025 to D0069 is the download area for the No. 0 Controller (E5CC-T), D0095 to D0139 is the download area for the No. 1 Controller, and D0165 to D0209 is the download area for the No. 2 Controller.

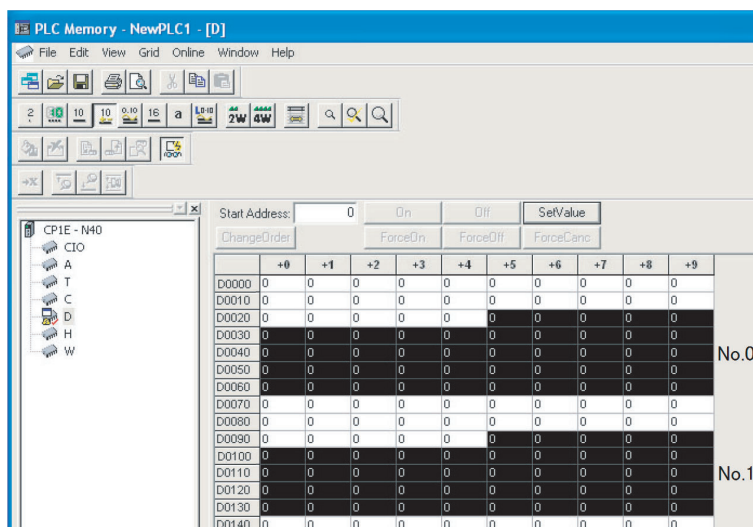

With the default settings, the following parameters are set for the download areas.

No.0	No.1	No.2	Parameter	Value
D0025	D0095	D0165	Request Flag (fixed)	1 (0001 hex)
D0026	D0096	D0166	Operation Command Code (fixed)	0 (0000 hex)
D0027	D0097	D0167	Fixed SP	0 (0000 hex)
D0028	D0098	D0168	PID 1 Proportional Band	80 (0050 hex)
D0029	D0099	D0169	PID 1 Integral Time	233 (00E9 hex)
D0030	D0100	D0170	PID 1 Derivative Time	40 (0028 hex)
D0031	D0101	D0171	Program 0 Alarm Value 1	0 (0000 hex)
D0032	D0102	D0172	Program 0 Alarm Upper Limit 1	0 (0000 hex)
D0033	D0103	D0173	Program 0 Alarm Lower Limit 1	0 (0000 hex)
D0034	D0104	D0174	Program 0 Alarm Value 2	0 (0000 hex)
D0035	D0105	D0175	Program 0 Alarm Upper Limit 2	0 (0000 hex)
D0036	D0106	D0176	Program 0 Alarm Lower Limit 2	0 (0000 hex)
D0037	D0107	D0177	Heater Burnout Detection 1	0 (0000 hex)
D0038	D0108	D0178	Process Value Input Shift	0 (0000 hex)
D0039	D0109	D0179	Wait Band	0 (0000 hex)
D0040	D0110	D0180	Standby Time	0 (0000 hex)
D0041	D0111	D0181	Program SP Shift Value	0 (0000 hex)
D0042	D0112	D0182	Program 0 Segment 0 SP	0 (0000 hex)
D0043	D0113	D0183	Program 0 Segment 0 Time	0 (0000 hex)
D0044	D0114	D0184	Program 0 Segment 1 SP	0 (0000 hex)
D0045	D0115	D0185	Program 0 Segment 1 Time	0 (0000 hex)
D0046	D0116	D0186	Program 0 Segment 2 SP	0 (0000 hex)
D0047	D0117	D0187	Program 0 Segment 2 Time	0 (0000 hex)
D0048	D0118	D0188	Program 0 Segment 3 SP	0 (0000 hex)
D0049	D0119	D0189	Program 0 Segment 3 Time	0 (0000 hex)
D0050	D0120	D0190	Program 0 Segment 4 SP	0 (0000 hex)
D0051	D0121	D0191	Program 0 Segment 4 Time	0 (0000 hex)
D0052	D0122	D0192	Program 0 Segment 5 SP	0 (0000 hex)
D0053	D0123	D0193	Program 0 Segment 5 Time	0 (0000 hex)
D0054	D0124	D0194	Program 0 Segment 6 SP	0 (0000 hex)
D0055	D0125	D0195	Program 0 Segment 6 Time	0 (0000 hex)
D0056	D0126	D0196	Program 0 Segment 7 SP	0 (0000 hex)
D0057	D0127	D0197	Program 0 Segment 7 Time	0 (0000 hex)
D0058	D0128	D0198	Program 0 Segment 8 SP	0 (0000 hex)
D0059	D0129	D0199	Program 0 Segment 8 Time	0 (0000 hex)
D0060	D0130	D0200	Program 0 Segment 9 SP	0 (0000 hex)
D0061	D0131	D0201	Program 0 Segment 9 Time	0 (0000 hex)
...
D0069	D0139	D0209	Nothing assigned.	

(2) We will initialize the download areas with the set values from the E5CC-T Controllers.

The download areas have not been initialized, so we will initialize them with the set values from the E5CC-T Controllers. Double-click **D0025** (Request Flag) in the PLC Memory Window. The following dialog box is displayed. Enter 2 (Initialize Download Areas) and click the **OK** Button.

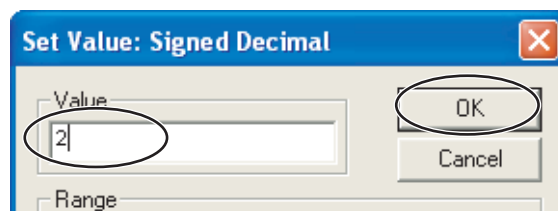

(3) We will confirm that the download areas have been initialized.

When initialization is completed, D0000 (Response Flag) will change to 1 (Normal End) and D0025 (Request Flag) will automatically change to 1 (Enable Writing). Check the download area to see if it has been initialized to the values given in the above table.

Confirm this for the No. 1 and No. 2 Controllers as well.

(4) We will change the fixed SP for the No. 0 Controller.

Double-click **D0027** (Fixed SP) in the PLC Memory Window, enter 100 (64 hex) for the value, and then click the **OK** Button. Confirm that D0000 (Request Flag) remains at 1 (Enable Writing) and that the SV Display on the No. 0 Controller changes to 100.

Confirm this for the No. 1 and No. 2 Controllers as well.

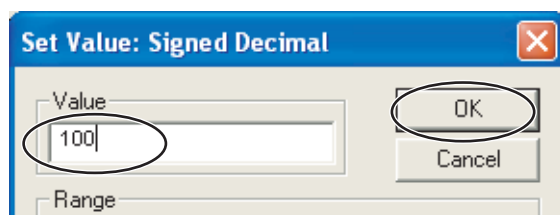

Resetting the E5CC-T Controllers

(1) We will change the values that are displayed for PLC memory to hexadecimal values.

In the PLC Memory Window, select **View – Display – Hexadecimal** from the menu bar.

(2) We will reset the No. 0 Controller.

Change the RUN/RESET parameter ($R-R$) in the operation level of the E5CC-T to RUN (RUN).

(3) The No. 0 Controller will change to reset status.

Confirm that **D0025** (Request Flag) in the PLC Memory Window is 0001 (Enable Writing), double-click **D0026** (Operation Command Code), enter 0101 hex (RESET), and then click the **OK** Button.

D0026 will change to 0000, D0000 (Response Flag) will remain at 0001 (Enable Writing), and "RST" will be displayed on the No. 0 E5CC-T Controller.

Confirm this for the No. 1 and No. 2 Controllers as well.

For details on other operation command codes, refer to *6-3-4 Operation Command Codes*.

6-5 Connecting to CJ-series PLCs

6-5-1 Configuration and Procedure

The following configuration is used as an example in giving the setup and application procedures for programless communications.

- All of the E5CC-T Controllers must be the same model. (Copying parameter settings is not possible if the models are different.)
- D0000 to D0209 are used in the PLC memory. The default E5CC-T parameter allocations are used.
- A commercially available USB2.0, A/B cable is used.

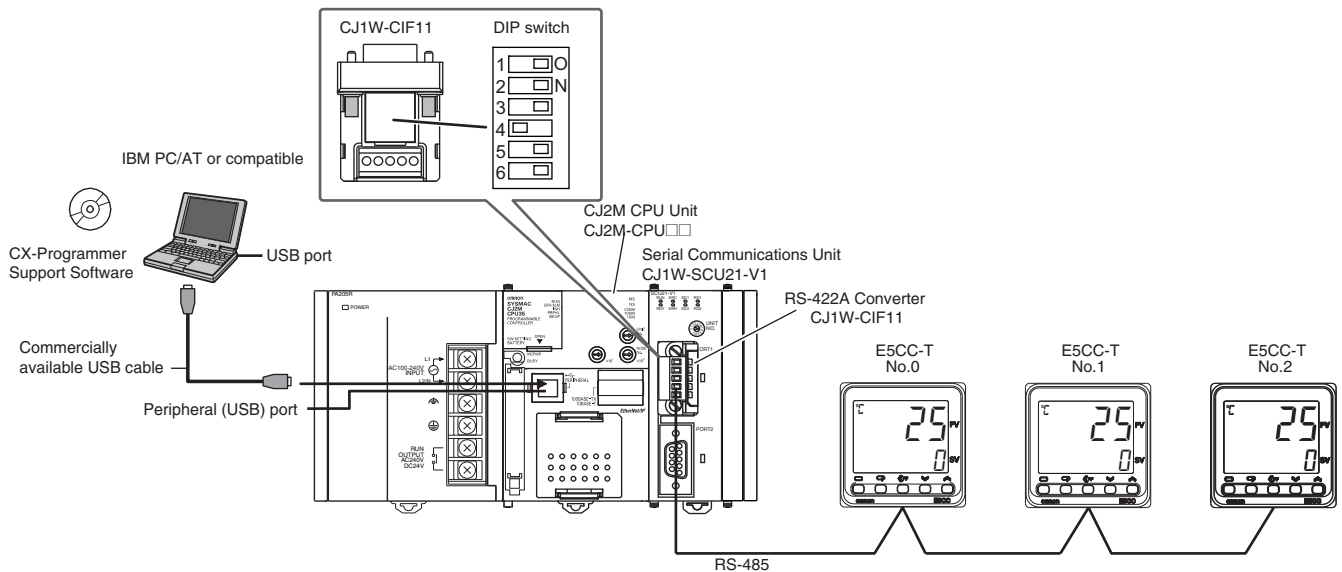

Note: Refer to the *CX-Programmer Operation Manual* (Cat. No. W446) for information on installing the CX-Programmer and USB driver.

The application procedure is given below.

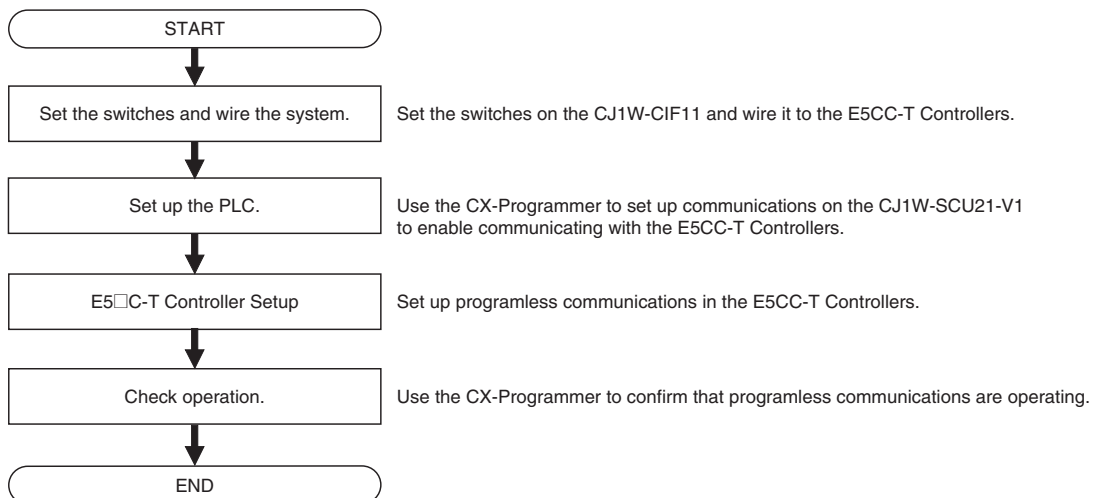

6-5-2 Switch Settings and Wiring

Before you attach the CJ1W-CIF11 to the CJ1W-SCU21-V1, turn OFF pin 4 on the DIP switch on the back of the CJ1W-CIF11 and turn ON the rest of the pins.

Pin	OFF	ON	Setting
1	No terminating resistance	Terminating resistance on both ends	Terminating resistance selection
2	4-wire	2-wire	2-wire or 4-wire selection
3	4-wire	2-wire	Same as above.
4	---	---	Not used.
5	RS control disabled. (Signal always received.)	RS control enabled.	RS control selection for RD
6	RS control disabled. (Signal always sent.)	RS control enabled.	RS control selection for SD

Wire the CP1W-CIF11 to the E5CC-T Controllers as shown below.

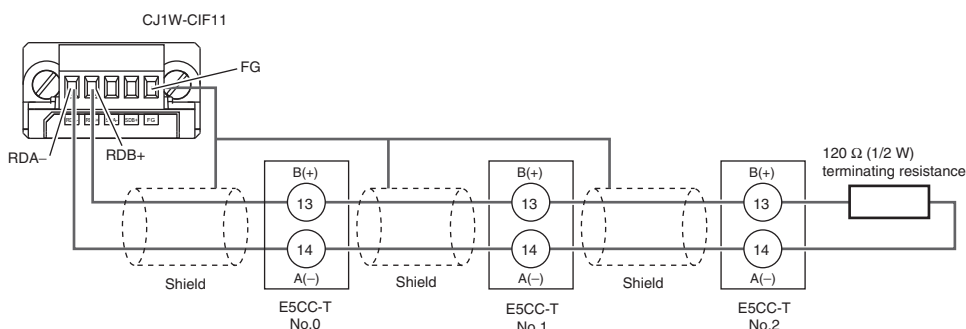

- Note: 1 The maximum transmission distance is 50 m.
 2 For wiring methods, refer to *Appendix G CJ1W-CIF11 RS-422A Converter* in the *SYSMAC CJ/NSJ Series Operation Manual* (Cat. No. W393).

6-5-3 PLC Setup

Set up communications on the CJ1W-SCU21-V1 to enable communicating with the E5CC-T Controllers.

PLC operation will stop and the power supply will be cycled during the setup procedure. Make sure that this will not create any problems in the controlled system.

Connecting to the PLC

Refer to *Connecting to the PLC* in *6-4-3 PLC Setup*.

Communications Settings in the Serial Communications Unit (SCU)

- (1) The PLC operating mode must be changed to PROGRAM mode to enable changing the SCU communications settings.

Select **PLC – Operating Mode – Program** from the menu bar. A confirmation dialog box will be displayed. Click the **Yes** Button.

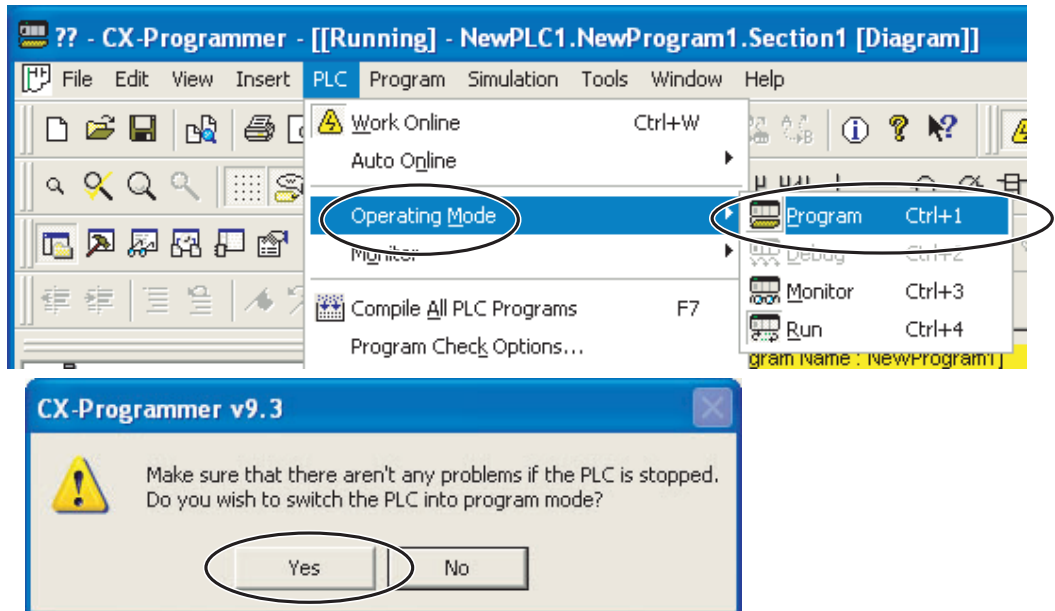

- (2) Double-click IO Table and Unit Setup. The IO Table Window will be displayed.

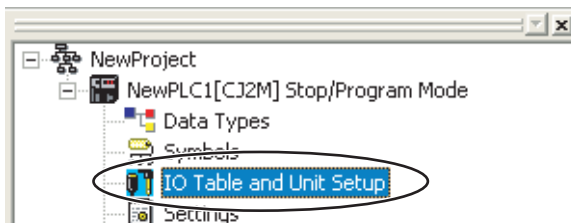

- (3) Double-click CJ1W-SCU21-V1. The CJ1W-SCU21-V1 Setting Window will be displayed.

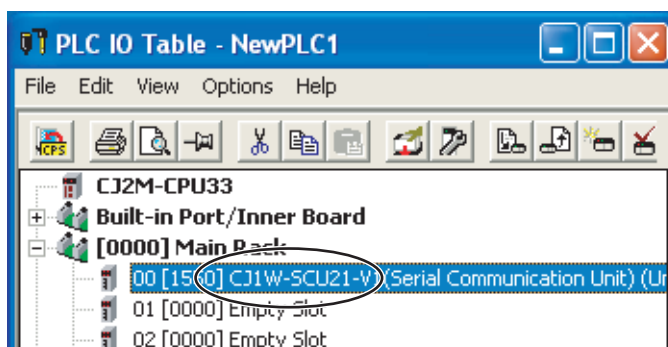

(4) We will change the communications settings for port 1.

Set Port 1: Port settings to User settings, set Port 1: Baud rate to 57600 bps, and then click the **Transfer [PC to Unit]** Button. Use the defaults settings for the other parameters.

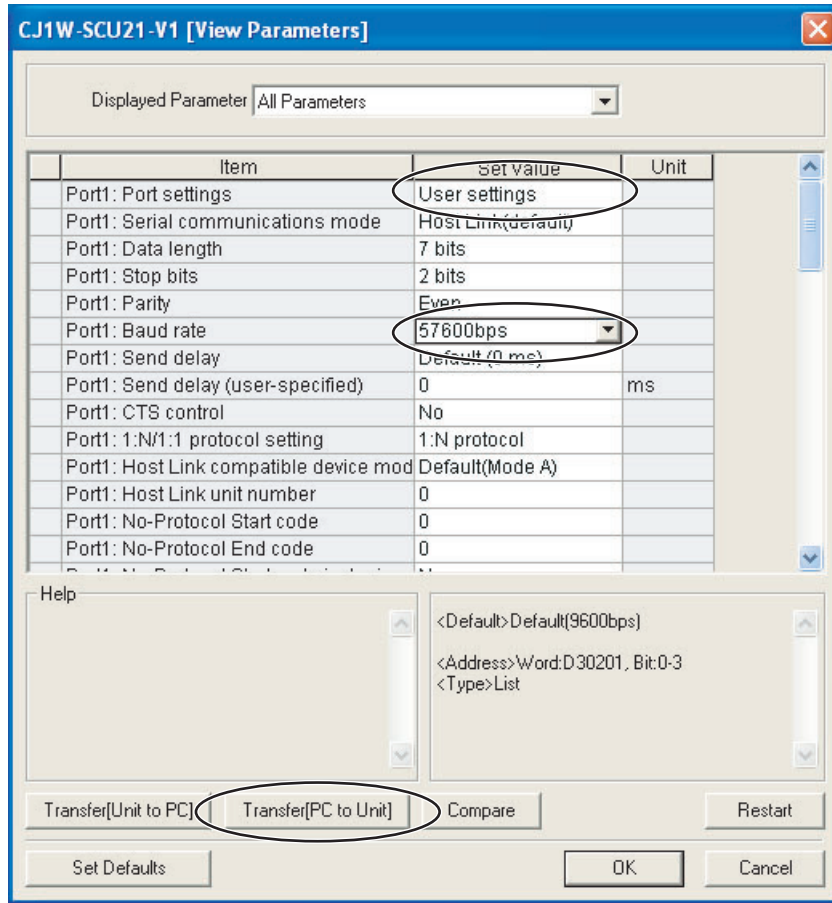

Note: If you change the unit number, refer to 6-2-7 Communications Node Number.

Click the **Yes** Button. The settings will be transferred. After the data has been transferred, click the **OK** Button.

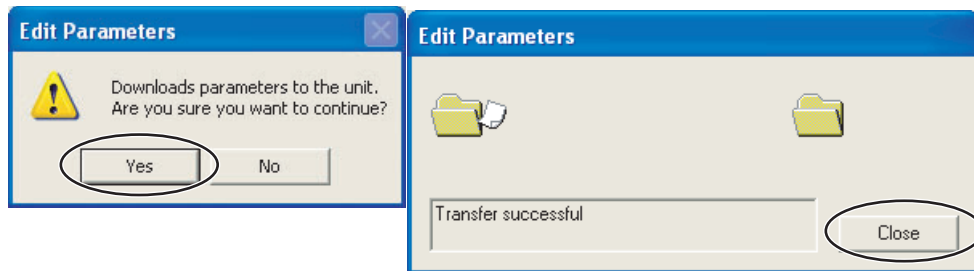

Click the **Yes** Button to restart the Unit. Select **All ports** and then click the **OK** Button. A dialog box will be displayed when the Unit has been restarted. Click the **OK** Button. This completes the PLC setup procedure. You will use the CX-Programmer to check operation, so leave it online.

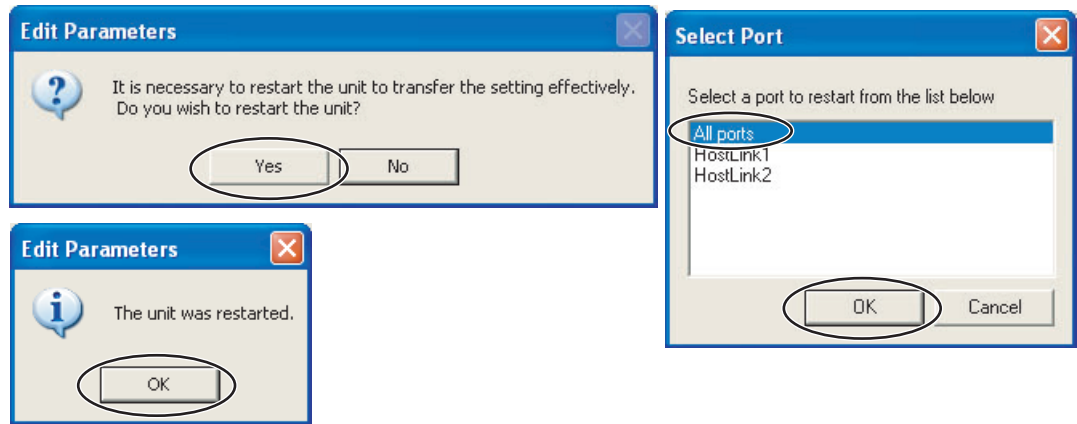

6-5-4 E5□C-T Controller Setup

Set up programless communications. Perform the procedure that is given in *6-4-4 E5□C-T Controller Setup*.

6-5-5 Checking Operation

Perform the procedure that is given in *6-4-5 Checking Operation*.

6-6 Connecting to MELSEC Q-series PLCs

6-6-1 Configuration and Procedure

The following configuration is used as an example in giving the setup and application procedures for programless communications.

- All of the E5CC-T Controllers must be the same model. (Copying parameter settings is not possible if the models are different.)
- D0 to D209 are used in the PLC memory. The default E5CC-T parameter allocations are used.
- A commercially available USB2.0, A/B cable is used.

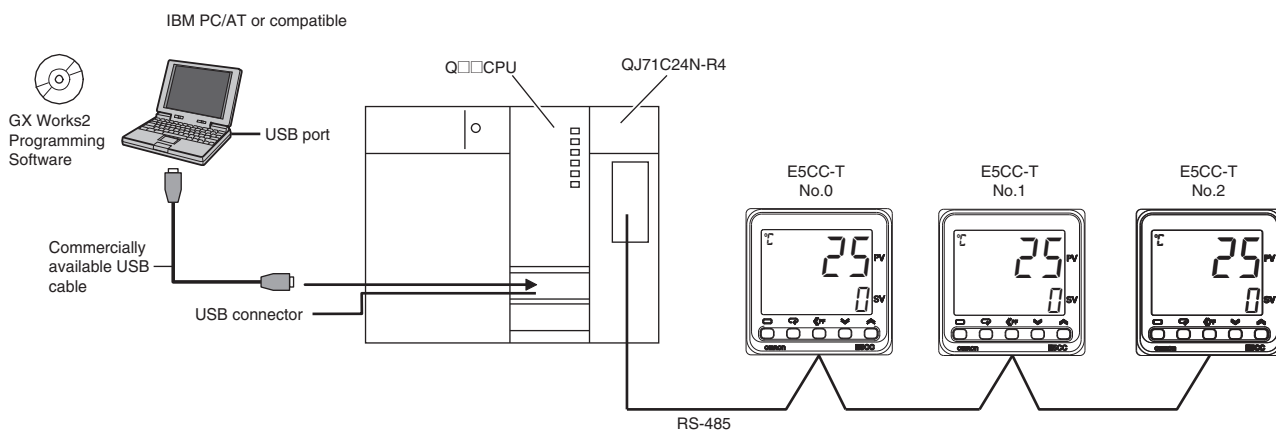

Note: Refer to the *GX Works2 Installation Instructions (BCN-P5713)* for information on installing the GX Works2 and to the *GX Works2 Version 1 Operating Manual (Common) (SH-080779ENG)* for information on installing the USB driver.

The application procedure is given below.

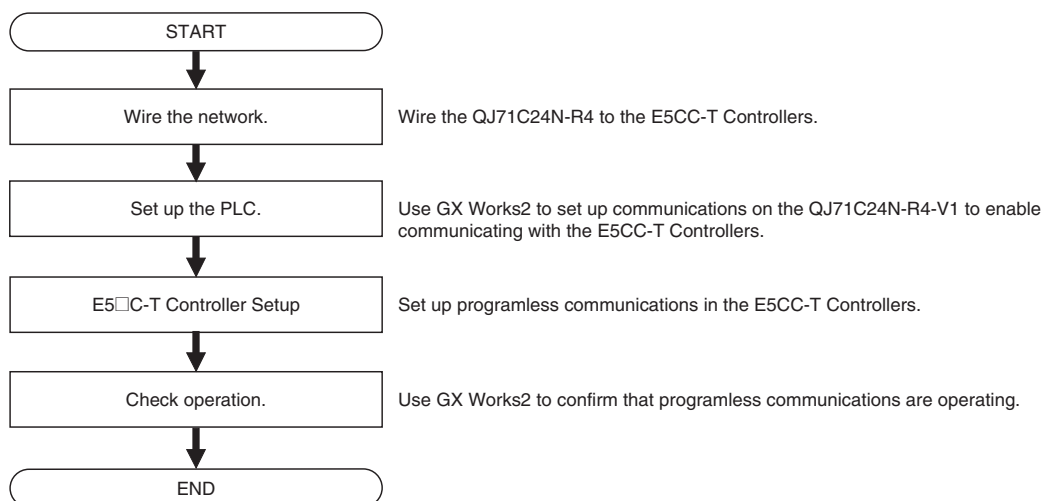

6-6-2 Wiring

Wire the QJ71C24N-R4 to the E5CC-T Controllers as shown below.

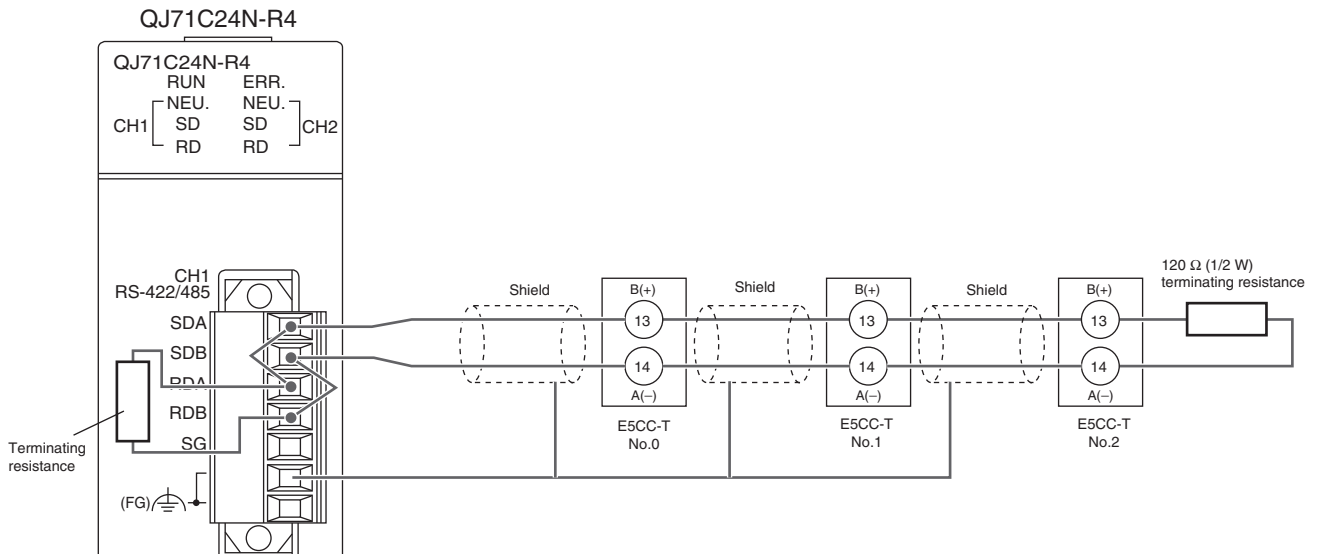

- Note:
- 1 Use a terminating resistance of at least 54 Ω.
 - 2 The maximum transmission distance is 500 m.
 - 3 For wiring methods, refer to 3.3 RS-422/485 Interface Specifications and 4.4.2 Connecting the RS-422/485 Interface in the Q Corresponding Serial Communication Module Users Manual (Basic) (SH-080006).

6-6-3 PLC Setup

Set up communications on the QJ71C24N-R4 to enable communicating with the E5CC-T Controllers. PLC operation will stop and the power supply will be cycled during the setup procedure. Make sure that this will not create any problems in the controlled system.

Connecting to the PLC

- (1) Connect the computer to the Q-series CPU Module and then start GX Works2.
- (2) Select **Online – Read from PLC** from the menu bar.

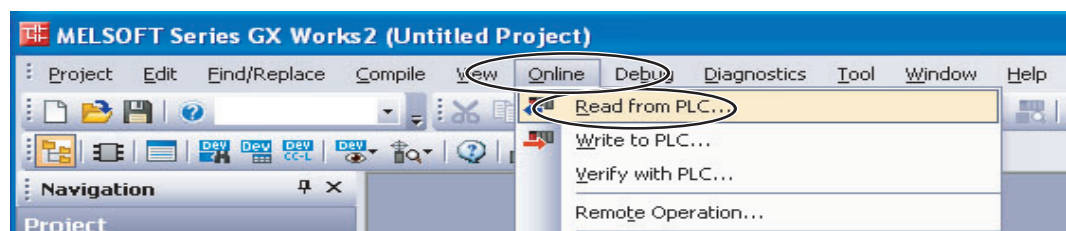

- (3) Select **QCPU (Q mode)**, and then click the OK Button.

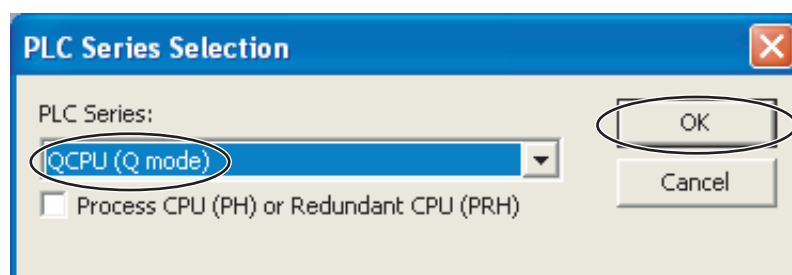

(4) Click the OK Button.

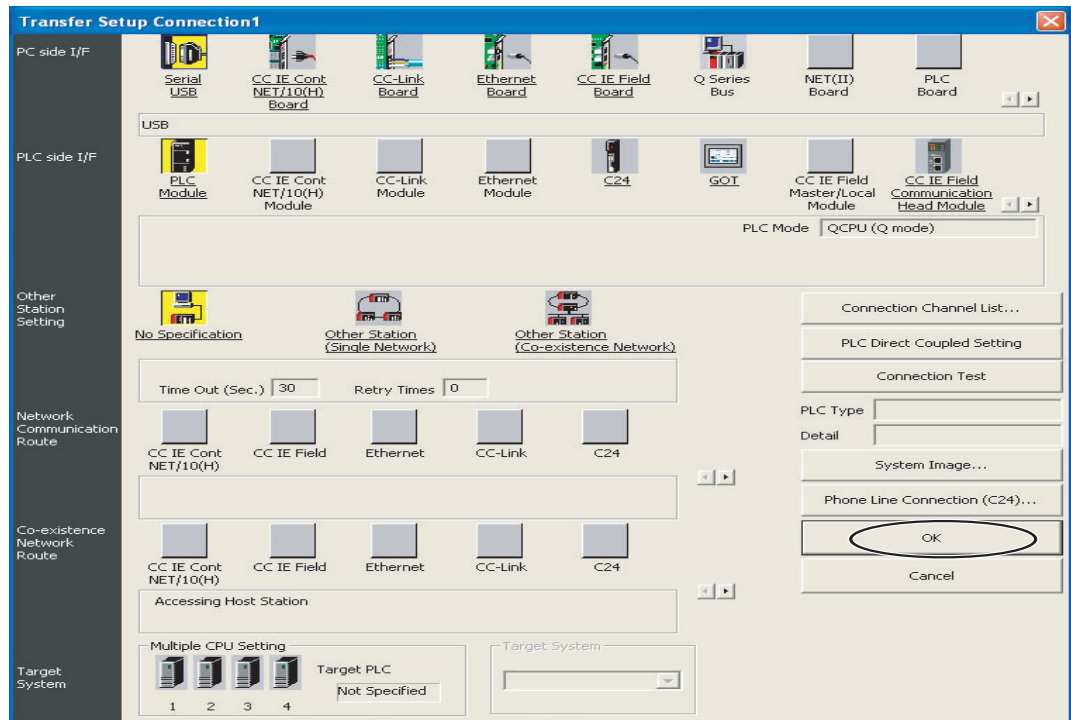

(5) Click the Execute Button.

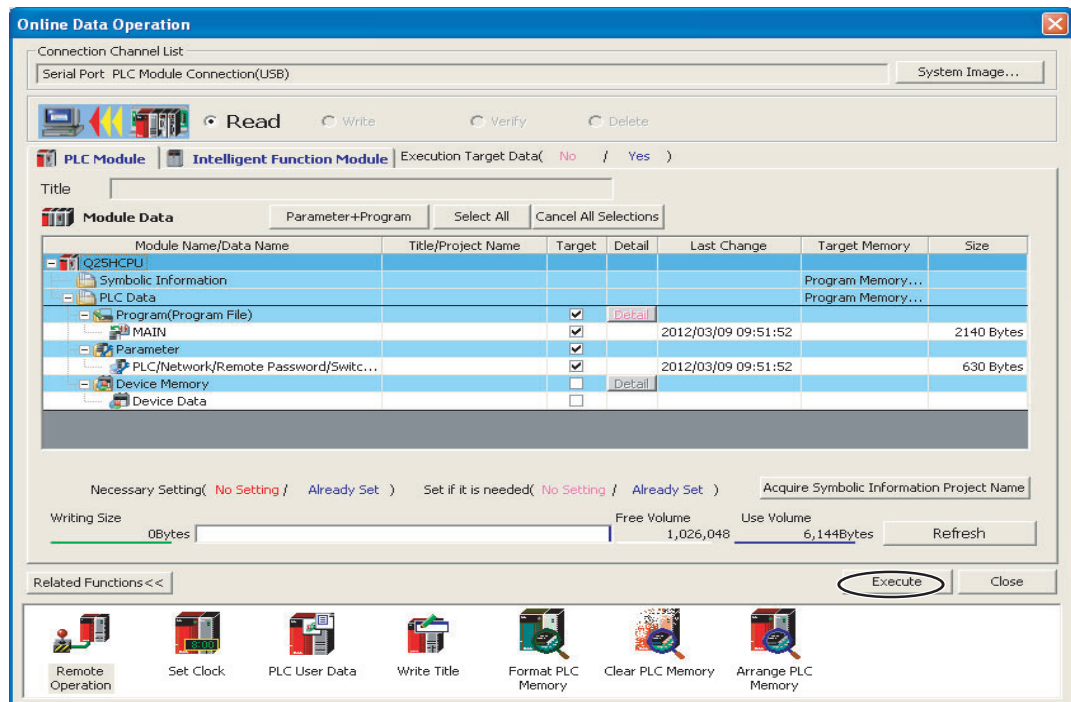

- (6) When the set values have been read, click the Close Button. Also close the above dialog box.

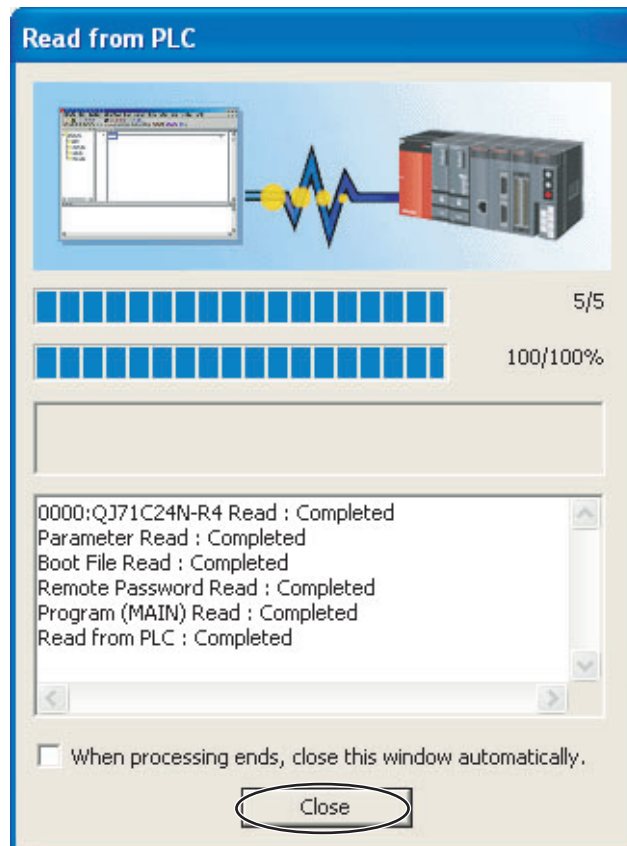

Communications Settings in the Serial Communication Module

- (1) Double-click Switch Setting. The Switch Setting Dialog Box for communications will be displayed.

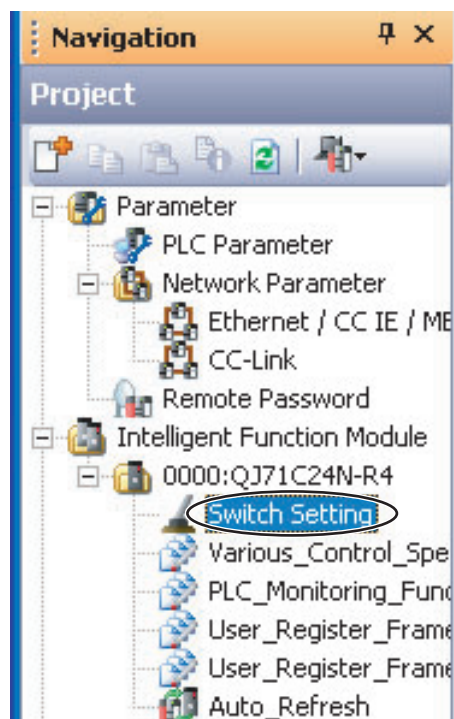

(2) We will change the communications settings for CH1.

Change the following settings, and then click the **OK** Button. Use the defaults settings for the other parameters.

- Parity Bit: Exist
- Even/odd parity: Even
- Stop bit: 2
- Sum check code: Exist
- Online Change: Enable
- Setting modifications: Enable
- Communication rate setting: 57600 bps (This setting can be changed after you change the communication protocol setting.)
- Communication protocol setting: MC protocol (Format 4)

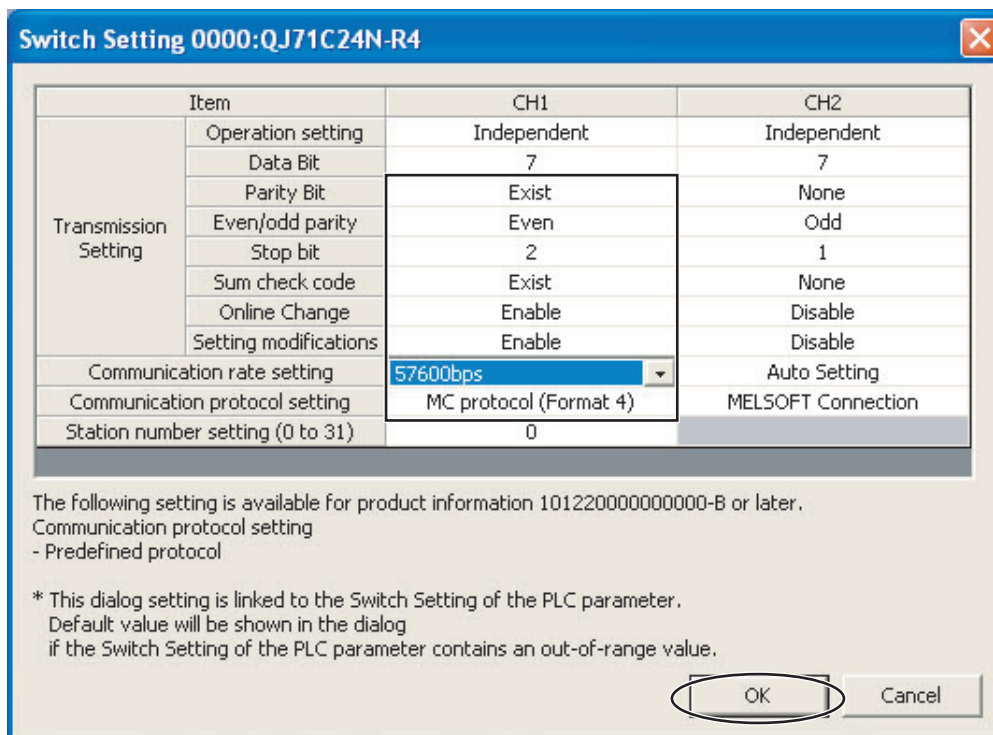

Note: If you change the station number setting, refer to *6-2-7 Communications Node Number*

(3) Select *Online - Write to PLC*. A dialog box to write the set values will be displayed.

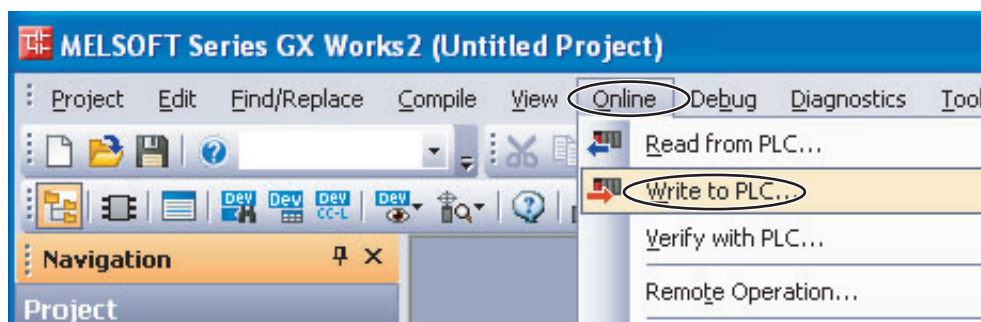

(4) We will write set values to the PLC.

Click the **Intelligent Function Module** Tab and select the check box for the Serial Communication Module in the *Valid* Column. Then click the **PLC Module** Tab, select the check box for the parameters in the Target Column, and then click the **Execute** Button.

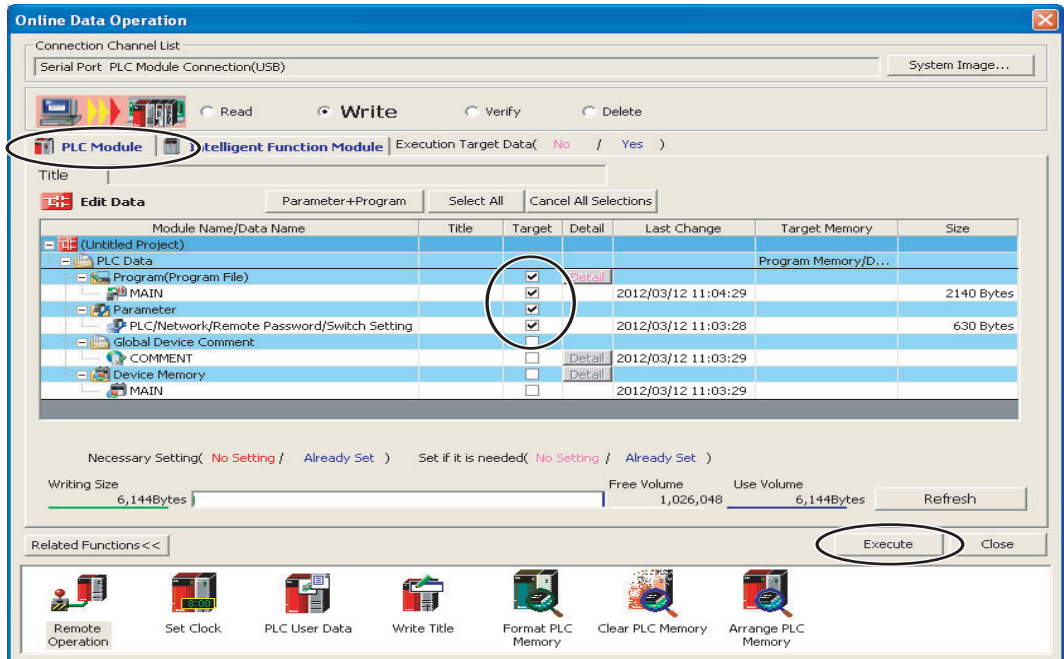
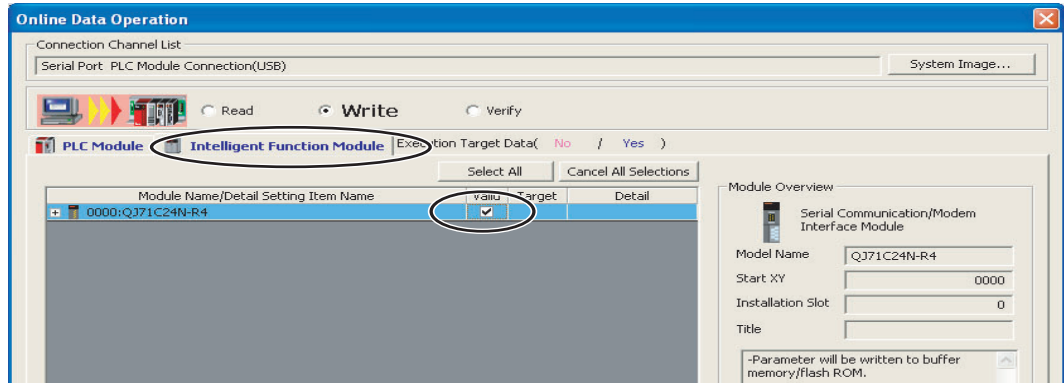

(5) We will write set values to the PLC.

Some dialog boxes will be displayed before and after the following dialog box. Click the **Yes** Button for of them, or click the **Yes to All** Button.

When the following dialog box is displayed, click the **Close** Button. Also close the dialog box to write set values, and then cycle the power supply to the PLC.

This completes the PLC setup procedure. You will use GX Works2 to check operation, so leave it online.

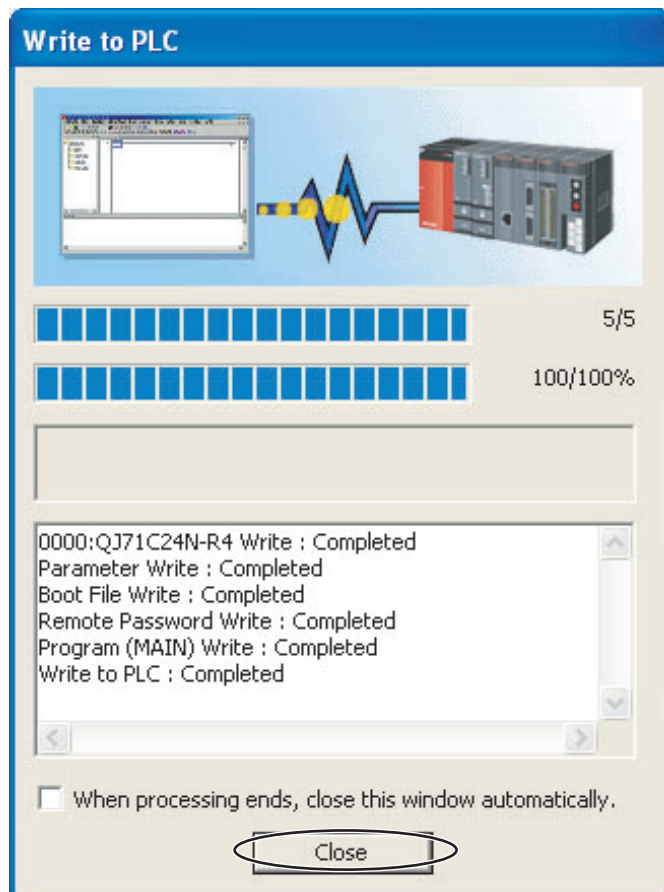
**6-6-4 E5□C-T Controller Setup**

Set up programless communications. Perform the procedure that is given in *6-4-4 E5□C-T Controller Setup*.

6-6-5 Checking Operation

The fixed SP and RUN/RESET status of the E5□C-T Controllers will be changed to check operation. Make sure that this will not create any problems in the controlled system.

● Checking E5CC-T Monitor Values

(1) We will display PLC memory in a dialog box.

Select **Online – Monitor – Device/Buffer Memory Batch Monitor**.

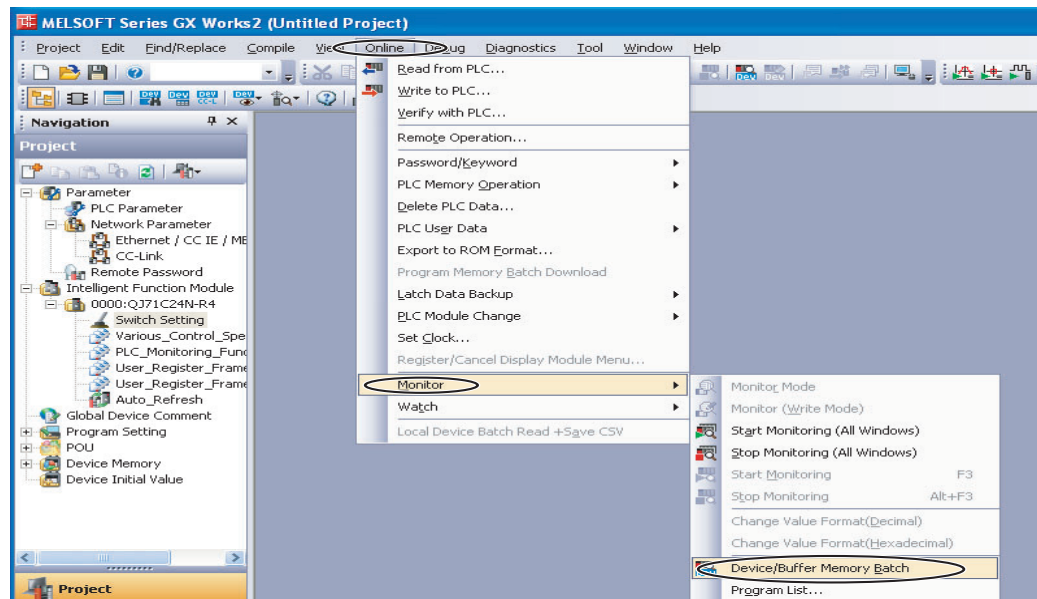

(2) We will monitor PLC memory in a dialog box.

Enter **D0** for in the *Device Name* Box and press the **Enter** Key on the computer's keyboard. Monitoring of D0 will be started.

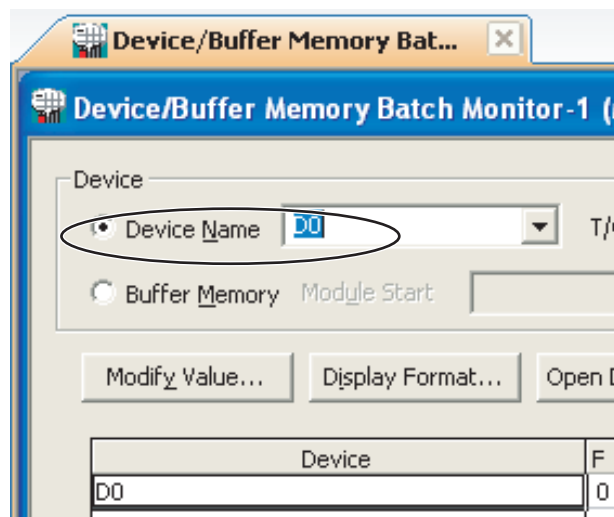

- (3) To make the value easier to check, we will change the values that are displayed to decimal values.

Click the **Display Format** Button in the above dialog box, select the *Word Multi-point* Option in the Monitor Format Area, select the *10 Points* Option in the Word Device Word Multi-point Format Area, and then click the **OK** Button.

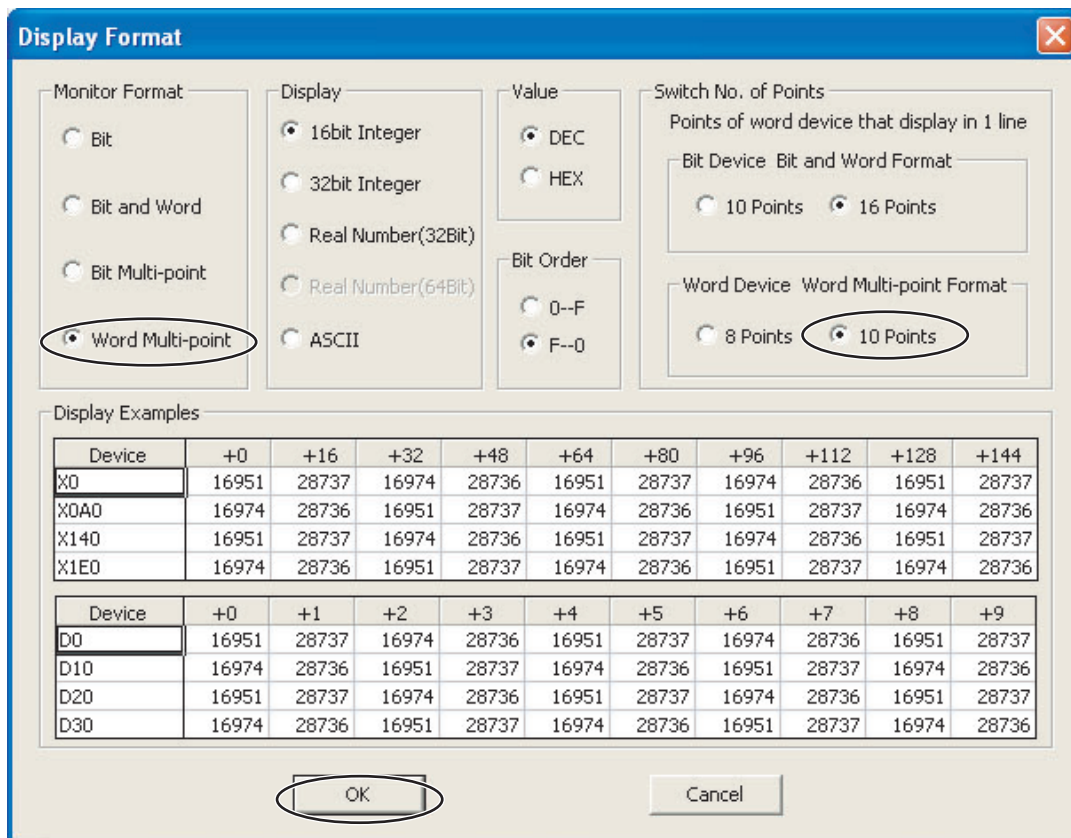

- (4) We will check the E5CC-T monitor values.

The area where monitor values are checked is called the upload area. D0 to D24 is the upload area for the No. 0 Controller (E5CC-T), D70 to D94 is the upload area for the No. 1 Controller, and D140 to D164 is the upload area for the No. 2 Controller.

Device Memory MAIN										
	+0	+1	+2	+3	+4	+5	+6	+7	+8	+9
D0	0	0	0	0	0	0	0	0	0	0
D10	0	0	0	0	0	0	0	0	0	0
D20	0	0	0	0	0	0	0	0	0	0
D30	0	0	0	0	0	0	0	0	0	0
D40	0	0	0	0	0	0	0	0	0	0
D50	0	0	0	0	0	0	0	0	0	0
D60	0	0	0	0	0	0	0	0	0	0
D70	0	0	0	0	0	0	0	0	0	0
D80	0	0	0	0	0	0	0	0	0	0
D90	0	0	0	0	0	0	0	0	0	0
D100	0	0	0	0	0	0	0	0	0	0
D110	0	0	0	0	0	0	0	0	0	0
D120	0	0	0	0	0	0	0	0	0	0
D130	0	0	0	0	0	0	0	0	0	0
D140	0	0	0	0	0	0	0	0	0	0
D150	0	0	0	0	0	0	0	0	0	0
D160	0	0	0	0	0	0	0	0	0	0
D170	0	0	0	0	0	0	0	0	0	0
D180	0	0	0	0	0	0	0	0	0	0

No.0
No.1
No.2

With the default settings, the following parameters are set for the upload areas.

Check the values in the upload areas to see if they are the same as those that are given in the following table. (It is not necessary to check address for which “---” is given in the Value column.)

No.0	No.1	No.2	Parameter	Value
D0000	D0070	D0140	Response Flag (fixed)	0
D0001	D0071	D0141	Communications Status (fixed)	Alternates between 0 and 1.
D0002	D0072	D0142	Communications Monitor	---
D0003	D0073	D0143	Status (Upper Word)	---
D0004	D0074	D0144	Status (Lower Word)	---
D0005	D0075	D0145	Status 2 (Upper Word)	---
D0006	D0076	D0146	Decimal Point Monitor	---
D0007	D0077	D0147	Process Value	Process Value *
D0008	D0078	D0148	Present SP	---
D0009	D0079	D0149	Internal Set Point	---
D0010	D0080	D0150	Heater Current 1 Value Monitor	---
D0011	D0081	D0151	PID Set No. Monitor	---
D0012	D0082	D0152	Program No. Monitor	---
D0013	D0083	D0153	Segment No. Monitor	---
D0014	D0084	D0154	Remaining Standby Time Monitor	---
D0015	D0085	D0155	Elapsed Program Time Monitor	---
D0016	D0086	D0156	Remaining Program Time Monitor	---
D0017	D0087	D0157	Elapsed Segment Time Monitor	---
D0018	D0088	D0158	Remaining Segment Time Monitor	---
D0019	D0089	D0159	Program Execution Repetitions Monitor	---
...
D0024	D0094	D0164	Not used.	---

* If the default settings are used and a sensor is not connected, the PV display on the E5CC-T will show an input error (S.ERR) and the process value in the upload area will be 1320 (528 hex).

● Changing E5CC-T Settings

(1) We will check the area that is used to change E5CC-T set values.

The area that is used to change the set value is called the download area.

D25 to D69 is the download area for the No. 0 Controller (E5CC-T), D95 to D139 is the download area for the No. 1 Controller, and D165 to D209 is the download area for the No. 2 Controller.

	+0	+1	+2	+3	+4	+5	+6	+7	+8	+9
D0	0	0	0	0	0	0	0	0	0	0
D10	0	0	0	0	0	0	0	0	0	0
D20	0	0	0	0	0	0	0	0	0	0
D30	0	0	0	0	0	0	0	0	0	0
D40	0	0	0	0	0	0	0	0	0	0
D50	0	0	0	0	0	0	0	0	0	0
D60	0	0	0	0	0	0	0	0	0	0
D70	0	0	0	0	0	0	0	0	0	0
D80	0	0	0	0	0	0	0	0	0	0
D90	0	0	0	0	0	0	0	0	0	0
D100	0	0	0	0	0	0	0	0	0	0
D110	0	0	0	0	0	0	0	0	0	0
D120	0	0	0	0	0	0	0	0	0	0
D130	0	0	0	0	0	0	0	0	0	0
D140	0	0	0	0	0	0	0	0	0	0
D150	0	0	0	0	0	0	0	0	0	0
D160	0	0	0	0	0	0	0	0	0	0
D170	0	0	0	0	0	0	0	0	0	0
D180	0	0	0	0	0	0	0	0	0	0

No.0

No.1

No.2

With the default settings, the following parameters are set for the download areas.

No.0	No.1	No.2	Parameter	Value
D0025	D0095	D0165	Request Flag (fixed)	1 (0001 hex)
D0026	D0096	D0166	Operation Command Code (fixed)	0 (0000 hex)
D0027	D0097	D0167	Fixed SP	0 (0000 hex)
D0028	D0098	D0168	PID 1 Proportional Band	80 (0050 hex)
D0029	D0099	D0169	PID 1 Integral Time	233 (00E9 hex)
D0030	D0100	D0170	PID 1 Derivative Time	40 (0028 hex)
D0031	D0101	D0171	Program 0 Alarm Value 1	0 (0000 hex)
D0032	D0102	D0172	Program 0 Alarm Upper Limit 1	0 (0000 hex)
D0033	D0103	D0173	Program 0 Alarm Lower Limit 1	0 (0000 hex)
D0034	D0104	D0174	Program 0 Alarm Value 2	0 (0000 hex)
D0035	D0105	D0175	Program 0 Alarm Upper Limit 2	0 (0000 hex)
D0036	D0106	D0176	Program 0 Alarm Lower Limit 2	0 (0000 hex)
D0037	D0107	D0177	Heater Burnout Detection 1	0 (0000 hex)
D0038	D0108	D0178	Process Value Input Shift	0 (0000 hex)
D0039	D0109	D0179	Wait Band	0 (0000 hex)
D0040	D0110	D0180	Standby Time	0 (0000 hex)
D0041	D0111	D0181	Program SP Shift Value	0 (0000 hex)
D0042	D0112	D0182	Program 0 Segment 0 SP	0 (0000 hex)
D0043	D0113	D0183	Program 0 Segment 0 Time	0 (0000 hex)
D0044	D0114	D0184	Program 0 Segment 1 SP	0 (0000 hex)
D0045	D0115	D0185	Program 0 Segment 1 Time	0 (0000 hex)
D0046	D0116	D0186	Program 0 Segment 2 SP	0 (0000 hex)
D0047	D0117	D0187	Program 0 Segment 2 Time	0 (0000 hex)
D0048	D0118	D0188	Program 0 Segment 3 SP	0 (0000 hex)
D0049	D0119	D0189	Program 0 Segment 3 Time	0 (0000 hex)
D0050	D0120	D0190	Program 0 Segment 4 SP	0 (0000 hex)
D0051	D0121	D0191	Program 0 Segment 4 Time	0 (0000 hex)
D0052	D0122	D0192	Program 0 Segment 5 SP	0 (0000 hex)
D0053	D0123	D0193	Program 0 Segment 5 Time	0 (0000 hex)
D0054	D0124	D0194	Program 0 Segment 6 SP	0 (0000 hex)
D0055	D0125	D0195	Program 0 Segment 6 Time	0 (0000 hex)
D0056	D0126	D0196	Program 0 Segment 7 SP	0 (0000 hex)
D0057	D0127	D0197	Program 0 Segment 7 Time	0 (0000 hex)
D0058	D0128	D0198	Program 0 Segment 8 SP	0 (0000 hex)
D0059	D0129	D0199	Program 0 Segment 8 Time	0 (0000 hex)
D0060	D0130	D0200	Program 0 Segment 9 SP	0 (0000 hex)
D0061	D0131	D0201	Program 0 Segment 9 Time	0 (0000 hex)
...
D0069	D0139	D0209	Not used.	

(2) We will initialize the download areas with the set values from the E5CC-T Controllers.

The download areas have not been initialized, so we will initialize them with the set values from the E5CC-T Controllers.

Double-click **D25** (Request Flag) on the Device Memory Dialog Box. The following dialog box is displayed. Enter 2 (Initialize Download Areas), click the **Set** Button, and then click the **Close** Button.

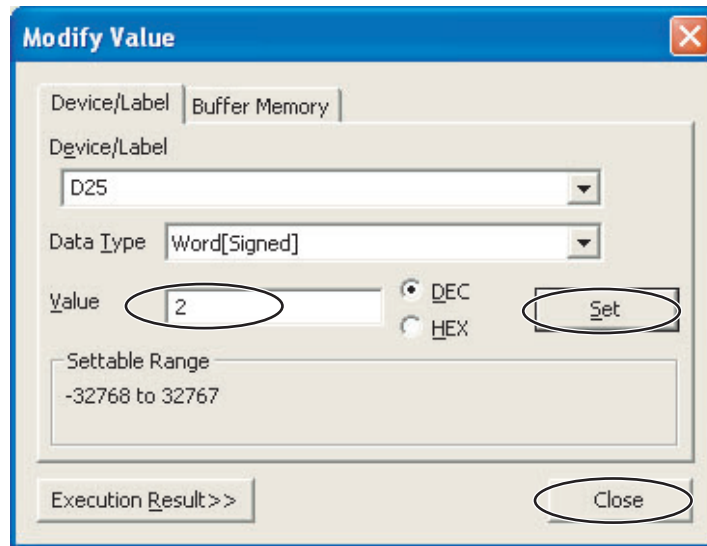
**(3) We will confirm that the download areas have been initialized.**

When initialization is completed, D0 (Response Flag) will change to 1 (Normal End) and D25 (Request Flag) will automatically change to 1 (Enable Writing). Check the download area to see if it has been initialized to the values given in the above table.

Confirm this for the No. 1 and No. 2 Controllers as well.

(4) We will change the set point for the No. 0 Controller.

Double-click **D27** (Fixed SP) in the Device Memory Dialog Box, enter 100 (64 hex) for the value, click the **Set** Button, and then click the **Close** Button. Confirm that D0 (Request Flag) remains at 1 (Enable Writing) and that the SV Display on the No. 0 Controller changes to 100.

Confirm this for the No. 1 and No. 2 Controllers as well.

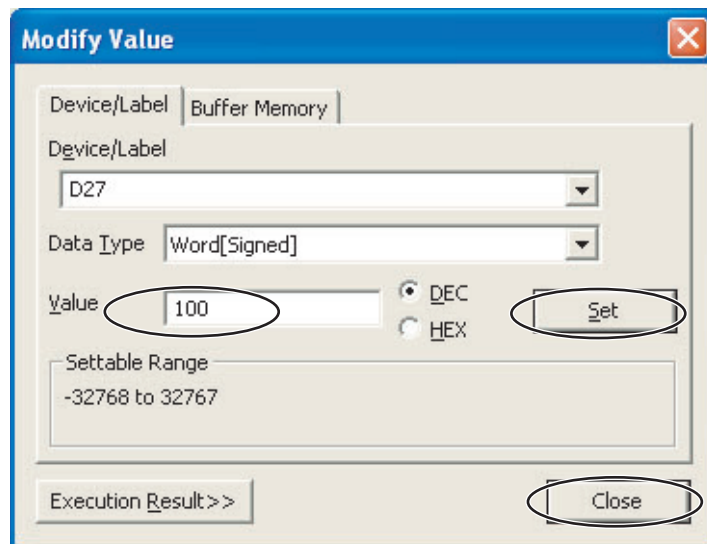

Resetting the E5CC-T Controllers

(1) We will run the No. 0 Controller.

Change the RUN/RESET parameter ($R-R$) in the operation level of the E5CC-T to RUN (RUN).

(2) The No. 0 Controller will change to reset status.

In the Device Memory Dialog Box, make sure that D25 (Request Flag) is 1 (Enable Writing) and then double-click **D26** (Operation Command Code). Select the HEX Option, enter 0101 hex (RESET), click the **Set** Button, and then click the **Close** Button. D26 will change to 0, D0 (Response Flag) will remain at 1 (Enable Writing), and "RST" will be displayed on the No. 0 E5CC-T Controller.

Confirm this for the No. 1 and No. 2 Controllers as well. For details on other operation command codes, refer to *6-3-4 Operation Command Codes*.

7

Component Communications

This section describes component communications for the E5□C-T.

7-1	Component Communications	7-2
7-1-1	Introduction	7-2
7-1-2	Wiring	7-3
7-1-3	E5□C-T Controller Setup	7-4
7-2	Operation for Component Communications	7-6
7-3	Troubleshooting	7-7

7-1 Component Communications

7-1-1 Introduction

You can use component communications to connect two or more E5□C slaves to the E5□C-T master via RS-485 and then transfer the fixed SP or program SP or change the RUN/RESET status for all of the Controllers at the same time. If you transfer the fixed SP or program SP or change the RUN/RESET status of the master (i.e., the Controller with a communications unit number of 0), the set points or RUN/RESET status of all of the slaves (i.e., the Controllers with communications unit numbers other than 0) that are connected via RS-485 will change automatically. When you transfer the set points, the set point from the master can be multiplied by a factor or offset at each slave.

- Transferring the Program SP (Program SP Mode)

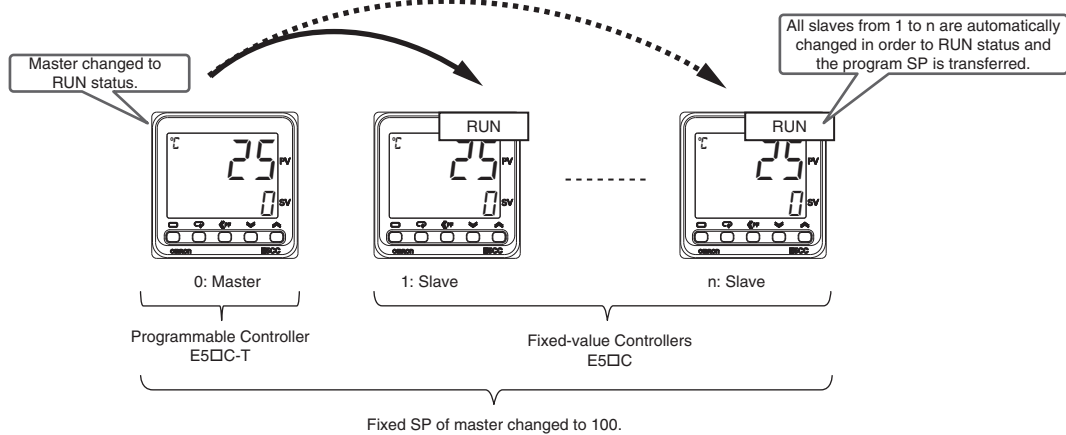

- Transferring the Fixed SP (Fixed SP Mode)

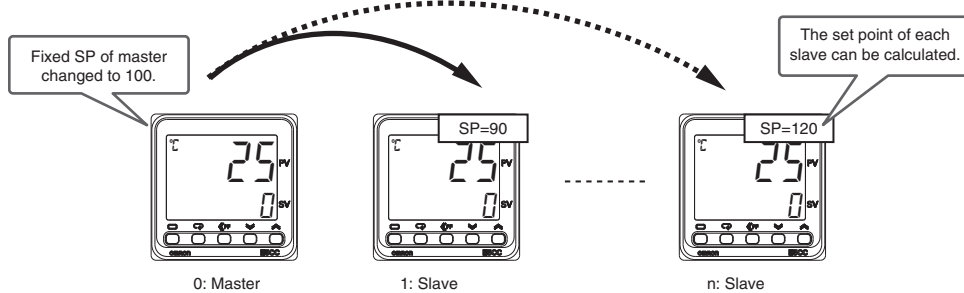

- Note 1 To use component communications, the input type and, if an analog input is used, the decimal point position must be set to the same values for all of the E5□C-T/E5□C Controllers. The operation will not work correctly if the position of the decimal point is different.
- 2 When the Reset Operation parameter is set to fixed SP operation, the SP mode status will automatically change according to the RUN/RESET status. In RUN status, the Controller will change to program SP mode. In RESET status, the Controller will change to fixed SP mode.
 - 3 The E5□C slave normally writes the set values to non-volatile memory (i.e., in Backup Mode). If you frequently change set values with component communications, use the Write Mode operation command to change to RAM Write Mode.

7-1-2 Wiring

Wire the E5□C-T Controllers as shown below.

E5CC-T/EC-T/AC-T

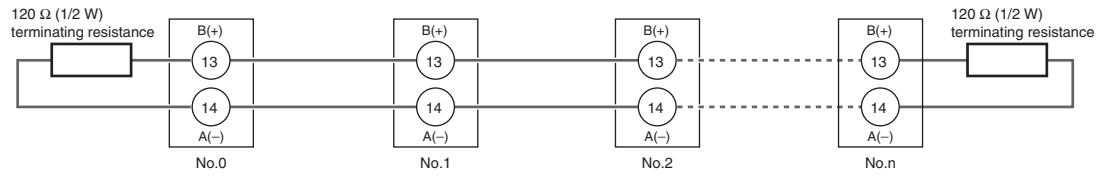

7-1-3 E5□C-T Controller Setup

This section describes the settings necessary to start component communications and the set point calculations that are used to perform target point calculations at the slaves.

To perform component communications, change the parameter settings in the communications setting level to the values that are given below.

* Parameter details are the same as for programless communications. Refer to 6-2 E5□C-T Controller Setup.

Parameter	Set value	
	Master (E5□C-T)	Slaves (E5□C)
Protocol setting	CMP	CMP
Communications unit number	0	A number is set for each slave in order from 1.
Communications baud rate	57.6 (recommended)	57.6 (recommended)
Send data wait time	1 (recommended)	1 (recommended)
Highest communications unit No.	Highest communications unit number of all the slaves	Setting is not necessary (The parameter is not displayed.)

Note: To use component communications, the input type and, if an analog input is used, the decimal point position must be set to the same values for all of the E5□C-T/E5□C Controllers. The operation will not work correctly if the position of the decimal point is different.

The parameters that are used for component communications are shown with a gray background in the following diagram. All of these parameters are displayed if you set the Protocol Setting parameter to *CMP*. (Some of the parameters are always displayed.)

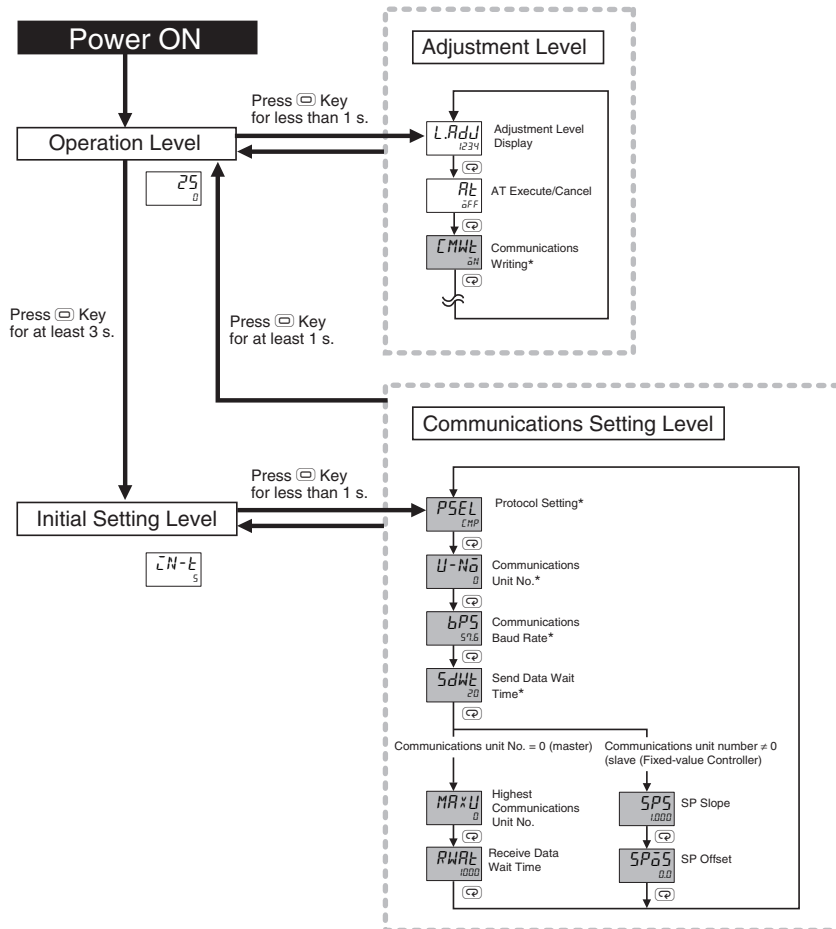

* These parameters are displayed regardless of the setting of the Protocol Setting parameter.

Note: The Communications Data Length, Communications Stop Bits, and Communications Parity parameters in the communications setting level are not displayed.

SP Calculations (Fixed-value Controllers Only)

The set point of a slave can be calculated from the fixed SP or program SP of the master as shown below. The slave performs the calculation only during operation. The value is not written to the slave if it exceeds the set point limiter.

During operation: Slave SP = Master SP × SP Slope + SP Offset

When stopped: Slave SP = Master SP

Communications Setting Level

Display condition: The Protocol Setting parameter must be set to \overline{MP} and the Communications Unit No. parameter must not be set to 0 (0 = master).

Parameter name	Displayed characters	Setting range	Unit	Default
SP Slope	\overline{SPS}	0.001 to 9.999	None	1.000
SP Offset	\overline{SPoS}	Temperature input: -199.9 to 999.9 Analog input: -1,999 to 9,999*	EU	0.0

* The decimal point position depends on the Decimal Point parameter setting.

7-2 Operation for Component Communications

Only two items can be sent from the master to the slaves: the fixed SP or program SP, and the RUN/RESET status.

If the set point or the RUN/RESET status is changed at the master, the new value is sent to the slaves starting with the slave with communications unit number 1 and continuing on to the slave with the highest communications unit number. The master sends values only during operation. Values are not sent while in the initial setting level.

If the RUN/RESET status is changed again while sending a previous value to the slaves, the original value will not be transferred correctly. Always wait for a value to be sent to all of the slaves before you change the RUN/RESET status again.

Levels		Component communications
Operation level, program setting level, adjustment level, PID setting level, manual control level, monitor/setting item level, and protect level	Setting area 0	Operates
Initial setting level, communications setting level, advanced function setting level, and calibration level	Setting area 1	Stops

For component communications, the master sends the value in order starting from slave 1. There will be a delay of up to 30 ms between when the set point or RUN/RESET status is sent to all of the slaves. However, in a control system with a fast response, the slaves may not be able to respond as quickly as the master. If you transfer the program SP with component communications, be prepared for a delay in operation due to a difference in timing.

If communications with a slave fail, the master will retry communications twice. If communications still fail, it will move to processing the next slave. To see if the value was sent correctly, check the display of the Set Point or STOP parameter on each slave.

● Exception Processing

Slaves	<ul style="list-style-type: none"> • SPs are not calculated when operation is stopped. • The value from the master is not received in the following cases. <ul style="list-style-type: none"> • When the set point from the master or the results of set point calculation exceeds the set point limiter of the slave. • When Communications Writing parameter is set to "OFF" • When RUN/RESET is assigned to an event input (Changes in the set point will be received.) • When a communications error occurs three times in a row
---------------	---

7-3 Troubleshooting

Possible problems that can occur with component communications and corrective actions are given in the following table.

Status	Cause and corrective action	Page
The set point or RUN/RESET status will not change for a slave (i.e., a Controller with a communications unit number other than 0).	The wiring to the slave is not correct.	7-3
	The communications settings for the slave are not correct. <ul style="list-style-type: none"> The Protocol Setting parameter is not set to \overline{CMP}. The Communications Unit No. parameter is set to the same value as another slave. The setting of the Communications Baud Rate parameter is not the same as the other slaves. The Highest Communications Unit No. parameter is not set to the highest communications unit number that is actually set. The Communications Writing parameter is set to OFF. 	7-4
	◆ When the RUN/RESET Does Not Change RUN/RESET is assigned to an event input for the slave.	7-6
	◆ When the Set Point Does Not Change The set point from the master or the results of set point calculations exceeds the set point limiter of the slave.	7-5 7-6
The set points or the RUN/RESET status will not change for any of the slaves.	The wiring to the master (i.e., the Controller with communications unit number 0) is not correct.	7-3
	The communications settings in the master are not correct. <ul style="list-style-type: none"> The Protocol Setting parameter is not set to \overline{CMP}. The Communications Unit No. parameter is not set to 0. The Communications Baud Rate parameter is not set to the same value as the slaves. The Highest Communications Unit No. parameter is not set to the highest communications unit number that is actually set. 	7-4
The set point is not calculated.	<ul style="list-style-type: none"> The SP Slope or SP Offset parameter is not set correctly. The set point was changed at the master when the slave was stopped (setting area 1). 	7-5
It is sometimes not possible to change the set points or RUN/RESET status.	There may be noise interference. Connect terminating resistance to both ends of the communications line.	7-3

Note: For information on other problems, refer to *A-2 Troubleshooting*.

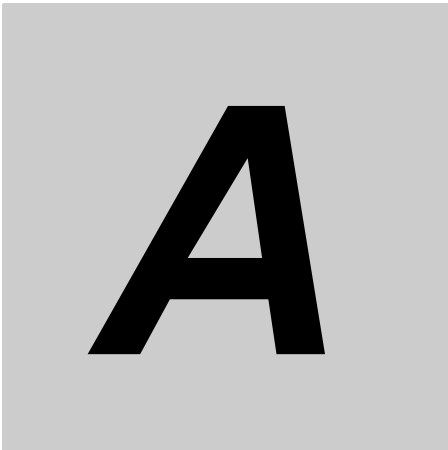

Appendices

A-1 ASCII List	A-2
A-2 Troubleshooting	A-3

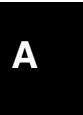

A-1 ASCII List

b8								
b7	0	0	0	0	1	1	1	1
b6	0	0	1	1	0	0	1	1
b5	0	1	0	1	0	1	0	1

b8	b7	b6	b5	b4	b3	b2	b1
↑ Even parity				0	0	0	0
				0	0	0	1
				0	0	1	0
				0	0	1	1
				0	1	0	0
				0	1	0	1
				0	1	1	0
				0	1	1	1
				1	0	0	0
				1	0	0	1
				1	0	1	0
				1	0	1	1
				1	1	0	0
				1	1	0	1
				1	1	1	0
				1	1	1	1

	C	0	1	2	3	4	5	6	7
R		0	1	2	3	4	5	6	7
0	NUL	DLE	SPACE	0	@	P	'	p	
1	SOH	DC1	!	1	A	Q	a	q	
2	STX	DC2	"	2	B	R	b	r	
3	ETX	DC3	#	3	C	S	c	s	
4	EOT	DC4	\$	4	D	T	d	t	
5	ENQ	NAK	%	5	E	U	e	u	
6	ACK	SYN	&	6	F	V	f	v	
7	BEL	ETB	'	7	G	W	g	w	
8	BS	CAN	(8	H	X	h	x	
9	HT	EM)	9	I	Y	i	y	
A	LF	SUB	*	:	J	Z	j	z	
B	VT	ESC	+	;	K	[k	{	
C	FF	FS	,	<	L	\	l		
D	CR	GS	-	=	M]	m	}	
E	S0	RS	.	>	N	^	n	~	
F	SI	US	/	?	O	_	o	DEL	

A-2 Troubleshooting

Before Requesting Repairs

If communications are not functioning properly, check the items in the following table before requesting repairs. If normal operation cannot be restored even after checking everything, return the product to your OMRON representative.

Problem: Communications are not possible or communications errors occur.

Item	Confirmation	Page
The communications wiring is not correct.	Correct the wiring.	1-4
The communications line has become disconnected.	Connect the communications line securely and tighten the screws.	---
The communications cable is broken.	Replace the cable.	---
The communications cable is too long.	The total cable length is 500 m maximum for RS-485 communications.	1-4
The wrong communications cable has been used.	Use a shielded, AWG24 to AWG18 (cross-sectional area of 0.205 to 0.823 mm ²) twisted-pair cable for the communications cable.	1-4
Too many communications devices are connected to the communications path.	When 1:N, RS-485 communications are used, a maximum of 32 nodes may be connected, including the host node.	1-4
An end node has not been set at each end of the communications line.	Set or connect terminating resistance at each end of the line. If the E5□C-T is the end node, 120-Ω (1/2-W) terminating resistance is used. Be sure that the combined resistance with the host device is 54 Ω minimum.	1-4
The specified power supply voltage is not being supplied to the Controller.	Supply the specified power supply voltage.	---
The specified power supply voltage is not being supplied to an Interface Converter (e.g., the K3SC).	Supply the specified power supply voltage.	---
The same baud rate and communications method are not being used by all of the Controllers, host devices, and other nodes on the same communications line.	Set the same values for the following on all nodes: baud rate, protocol, data length, stop bits, and parity.	1-2
The unit number specified in the command frame is different from the unit number set for the Controller.	Use the same unit number.	2-2 4-2
The same unit number as the Controller is being used for another node on the same communications line.	Set each unit number for only one node.	1-4
There is a mistake in programming in the host device.	Use a line monitor to check the commands.	---
The host device is detecting the absence of a response as an error before it receives the response from the Controller.	Shorten the send data wait time in the Controller or increase the response wait time in the host device.	1-5

Item	Confirmation	Page
The host device is detecting the absence of a response as an error after broadcasting a command or sending a software reset command.	The Controller does not return responses for broadcast or software reset commands.	2-2 2-17 4-2 4-14
The host device sent another command before receiving a response from the Controller.	Always read the response after sending a command (except for broadcast or software reset commands).	---
The host device sent the next command too soon after receiving a response from the Controller.	Wait for at least 2 ms after receiving a response before sending the next command.	1-2
The communications line became unstable when the Controller's power was turned ON or interrupted, and the host device read the unstable status as data.	Initialize the reception buffer in the host device before sending the first command and after turning OFF the power to the Controller.	---
The communications data was corrupted by noise from the environment.	Try using a slower baud rate. Separate the communications cable from the source of noise. Use a shielded, twisted-pair cable for the communications cable. Use as short a communications cable as possible and do not lay or loop extra cable. Do not run the communications cable parallel to a power line to prevent inductive noise. If noise countermeasures are difficult to implement, use an Optical Interface.	---



Index



Index

A	
<hr/>	
addresses	
CompoWay/F	2-7
Modbus	4-7
area definitions	2-6
areas and first address of linked data	6-8
ASCII list	A-2
B	
<hr/>	
BCC	2-2, 2-3
C	
<hr/>	
command frame	
CompoWay/F	2-2
Modbus	4-2
command text	2-2
communications baud rate	1-4, 1-5, 6-7
communications data	
CompoWay/F	2-4, 3-1
Modbus	5-1
communications data length	1-4, 1-5
communications monitor	6-19
communications node number	6-10
communications parameter setup	1-4
communications parameters	1-4
communications parity	1-4, 1-5
communications protocol	1-4, 1-5
communications specifications	1-2
communications stop bits	1-4, 1-5
communications unit No.	6-7
communications unit number	1-4, 1-5
communications writing	6-18
component communications	7-2
Composite Read from Variable Area	
(CompoWay/F)	2-7, 2-10
Composite Write to Variable Area	
(CompoWay/F)	2-7, 2-12
CompoWay/F	1-2, 2-1, 3-1
confirming operation of programless	
communications	6-22
copying parameter settings	6-15
CRC-16	4-2, 4-3
D	
<hr/>	
data	4-2
data format	
CompoWay/F	2-2
Modbus	4-2
description of communications parameters	1-5
double-word data	3-2
E	
<hr/>	
Echoback Test	
CompoWay/F	2-7, 2-15
Modbus	4-6, 4-14
end codes	
CompoWay/F	2-3, 2-4
error codes	
Modbus	4-5
ETX	2-2
F	
<hr/>	
FINS	1-2
Four-byte Mode	4-7, 5-2
function code	4-2
functions (Modbus)	
detailed description	4-8
list	4-6
H	
<hr/>	
highest communications unit No.	6-7
Host Link (FINS)	6-6, 6-10
I	
<hr/>	
interface	1-3
M	
<hr/>	
MC protocol (format 4)	6-6, 6-10
Modbus	1-2, 4-1, 5-1
N	
<hr/>	
no response	4-5
node number	2-2
number of elements	
CompoWay/F	2-7
Modbus	4-7
O	
<hr/>	
operation command	
CompoWay/F	2-7
Modbus	4-12
operation command codes	6-22
P	
<hr/>	
PDU structure	2-6
PLC	6-5
programless communications	6-3

protocol setting 1-5, 6-6

R

range of operation for programless
communications 6-22
Read Controller Attributes (CompoWay/F) 2-7, 2-13
Read Controller Status (CompoWay/F) 2-7, 2-14
Read Variable Area (CompoWay/F) 2-7, 2-8
receive data wait time 6-10
Request Flag 6-20
response code list (CompoWay/F) 2-22
Response Flag 6-21
response frame
CompoWay/F 2-3
Modbus 4-4
RS-485 1-3

S

send data wait time 1-4, 1-5, 6-7
services (CompoWay/F)
detailed description 2-8
list 2-7
set values (Modbus) 4-7
SID 2-2
single-word data 3-2
slave address 4-2
SP calculations 7-5
Status
CompoWay/F 3-31
Modbus 5-21
Status 2 (CompoWay/F) 3-31
STX 2-2
sub-address 2-2

T

transmission procedure 1-3
troubleshooting A-3
troubleshooting during component communications 7-7
troubleshooting during copying operation
under programless communications 6-17
troubleshooting during programless
communications 6-23
Two-byte Mode 4-7, 5-2
type code (variable type) 2-6

U

upload settings and download settings 6-11

V

variable area 4-7
variable area (setting range) list
CompoWay/F 3-2
Modbus 5-2
Variable Read, Multiple (Modbus) 4-8

variable type 2-6
Variable Write, Multiple (Modbus) 4-10
Variable Write, Single/Operation Command
(Modbus) 4-12
versions 10

W

wiring 1-3
Write Mode 6-22
Write Variable Area (CompoWay/F) 2-7, 2-9

OMRON Corporation Industrial Automation Company

Kyoto, JAPAN

Contact: www.ia.omron.com

Regional Headquarters

OMRON EUROPE B.V.

Wegalaan 67-69, 2132 JD Hoofddorp
The Netherlands
Tel: (31)2356-81-300/Fax: (31)2356-81-388

OMRON ELECTRONICS LLC

2895 Greenspoint Parkway, Suite 200
Hoffman Estates, IL 60169 U.S.A.
Tel: (1) 847-843-7900/Fax: (1) 847-843-7787

OMRON ASIA PACIFIC PTE. LTD.

No. 438A Alexandra Road # 05-05/08 (Lobby 2),
Alexandra Technopark,
Singapore 119967
Tel: (65) 6835-3011/Fax: (65) 6835-2711

OMRON (CHINA) CO., LTD.

Room 2211, Bank of China Tower,
200 Yin Cheng Zhong Road,
PuDong New Area, Shanghai, 200120, China
Tel: (86) 21-5037-2222/Fax: (86) 21-5037-2200

Authorized Distributor:

© OMRON Corporation 2014-2017 All Rights Reserved.
In the interest of product improvement,
specifications are subject to change without notice.

Cat. No. H186-E1-04

0117