

SIEMENS

SIMATIC

Industrial PC SIMATIC IPC127E

Operating Instructions





<u>Preface</u>	
<u>Overview</u>	1
<u>Safety instructions</u>	2
<u>Mounting and connecting the device</u>	3
<u>Commissioning the device and device functions</u>	4
<u>Device maintenance and repair</u>	5
<u>Technical specifications</u>	6
<u>Certificates and approvals</u>	7
<u>Directives and declarations</u>	8
<u>Dimension drawings</u>	9
<u>Hardware description</u>	10
<u>Technical support</u>	A
<u>Markings and symbols</u>	B
<u>List of abbreviations</u>	C

Legal information

Warning notice system

This manual contains notices you have to observe in order to ensure your personal safety, as well as to prevent damage to property. The notices referring to your personal safety are highlighted in the manual by a safety alert symbol, notices referring only to property damage have no safety alert symbol. These notices shown below are graded according to the degree of danger.

 DANGER
indicates that death or severe personal injury will result if proper precautions are not taken.
 WARNING
indicates that death or severe personal injury may result if proper precautions are not taken.
 CAUTION
indicates that minor personal injury can result if proper precautions are not taken.
NOTICE
indicates that property damage can result if proper precautions are not taken.

If more than one degree of danger is present, the warning notice representing the highest degree of danger will be used. A notice warning of injury to persons with a safety alert symbol may also include a warning relating to property damage.

Qualified Personnel

The product/system described in this documentation may be operated only by **personnel qualified** for the specific task in accordance with the relevant documentation, in particular its warning notices and safety instructions. Qualified personnel are those who, based on their training and experience, are capable of identifying risks and avoiding potential hazards when working with these products/systems.

Proper use of Siemens products

Note the following:

 WARNING
Siemens products may only be used for the applications described in the catalog and in the relevant technical documentation. If products and components from other manufacturers are used, these must be recommended or approved by Siemens. Proper transport, storage, installation, assembly, commissioning, operation and maintenance are required to ensure that the products operate safely and without any problems. The permissible ambient conditions must be complied with. The information in the relevant documentation must be observed.

Trademarks

All names identified by ® are registered trademarks of Siemens AG. The remaining trademarks in this publication may be trademarks whose use by third parties for their own purposes could violate the rights of the owner.

Disclaimer of Liability

We have reviewed the contents of this publication to ensure consistency with the hardware and software described. Since variance cannot be precluded entirely, we cannot guarantee full consistency. However, the information in this publication is reviewed regularly and any necessary corrections are included in subsequent editions.

Preface

Preface

These operating instructions contain all the information you need for commissioning and operation of the SIMATIC IPC127E.

It is intended both for programming and testing personnel who commission the device and connect it with other units (automation systems, programming devices), as well as for service and maintenance personnel who install add-ons or carry out fault/error analyses.

Basic knowledge required

A solid background in personal computers and Microsoft operating systems is required to understand this manual. General knowledge in the field of automation technology is recommended.

Scope of validity of this document

These operating instructions are valid for all versions of the SIMATIC IPC127E.

Scope of this documentation

The documentation for the SIMATIC IPC127E consists of:

- Product information, e.g. "Important notes on your device"
- Quick Install Guide SIMATIC IPC127E
- SIMATIC IPC127E operating instructions in English and German

If you ordered the device with an operating system, the documentation is supplied on the USB stick in PDF format (in multiple languages).

Conventions

The terms "PC" and "device" are sometimes used to refer to the SIMATIC IPC127E in this documentation.

Instead of the specific names of the operating system, we are using the abbreviation "Windows 10" throughout.

History

The following editions of these operating instructions have already been published:

Edition	Comment
01/2019	First edition

Table of contents

	Preface	3
1	Overview.....	9
1.1	Product description	9
1.1.1	Overview	9
1.2	Design of the devices.....	10
1.2.1	Interfaces and connections of Basic device	10
1.2.2	Interfaces and connections of Extended device	11
1.2.3	Status displays of the devices	13
1.3	Accessories.....	14
2	Safety instructions	15
2.1	General safety instructions	15
2.2	Industrial security.....	17
2.3	Notes on use.....	17
3	Mounting and connecting the device.....	19
3.1	Preparing for mounting	19
3.1.1	Checking the delivery package.....	19
3.1.2	Identification data of the device	21
3.1.3	Permitted mounting positions	23
3.2	Mounting the device.....	24
3.2.1	Mounting instructions	24
3.2.2	Mounting on a standard rail	26
3.2.3	Wall mounting	28
3.2.4	Upright mounting.....	29
3.2.5	Vertical mounting standard rail	30
3.3	Connecting the device	31
3.3.1	Notes on connecting	31
3.3.2	Connecting the protective conductor	33
3.3.3	Connecting the power supply	34
3.3.4	Connecting the device to networks.....	36
4	Commissioning the device and device functions.....	37
4.1	General information on commissioning	37
4.2	Switching the device on/off	38
4.3	Extended device functions.....	39
4.3.1	Monitoring functions.....	39
4.3.1.1	Overview of the monitoring functions.....	39
4.3.1.2	Temperature monitoring/display	40
4.3.1.3	Watchdog (WD)	41
4.3.1.4	Battery monitoring.....	42

5	Device maintenance and repair	43
5.1	Maintenance.....	43
5.2	Repair information.....	44
5.3	Replace the backup battery	45
5.4	Replacing the SSD.....	48
5.5	Installing the software	51
5.5.1	Reinstalling the operating system.....	51
5.5.2	Delivery state of the pre-installed software.....	51
5.5.2.1	Boot mode.....	51
5.5.2.2	Partitions under Windows 10	51
5.6	Backing up data	52
5.7	Configuring firmware/BIOS	52
5.8	Recycling and disposal	52
6	Technical specifications	53
6.1	General technical specifications	53
6.2	Ambient conditions.....	56
6.3	Power demand of the components	57
6.4	Direct current supply (DC)	58
7	Certificates and approvals	59
7.1	CE marking	59
7.2	DIN ISO 9001 certificate and software license agreements	59
7.3	UL61010 approval.....	59
7.4	FCC (USA) compliance.....	60
7.5	Canada.....	60
7.6	Australia	61
7.7	Eurasian Customs Union EAC.....	61
7.8	Korea.....	61
8	Directives and declarations.....	63
8.1	Electromagnetic Compatibility, Industrial and Residential Areas	63
8.2	ESD guideline	64
9	Dimension drawings	67
9.1	Dimension drawing basic device.....	67
9.2	Dimension drawing Extended device.....	71

10	Hardware description	75
10.1	Technical features of the motherboard.....	75
10.2	External interfaces.....	75
10.2.1	Overview of interfaces.....	75
10.2.2	USB 3.0 port.....	75
10.2.3	DisplayPort.....	76
10.2.4	Ethernet port.....	77
10.3	System resources.....	78
10.3.1	Currently allocated system resources.....	78
10.4	Input/output address areas.....	78
10.4.1	Overview of the internal module registers.....	78
10.4.2	Watchdog register.....	79
10.4.3	MMIO GPIO addresses for LEDs and battery monitoring.....	82
A	Technical support	83
A.1	Service and support.....	83
A.2	Troubleshooting.....	84
B	Markings and symbols	87
B.1	Overview.....	87
B.2	Safety.....	87
B.3	Operator controls.....	87
B.4	Certificates, approvals and markings.....	88
B.5	Interfaces.....	89
C	List of abbreviations	91
C.1	Abbreviations.....	91
	Glossary	93
	Index	99

Overview

1.1 Product description

1.1.1 Overview



SIMATIC IPC127E provides high-level industrial functionality.

- Compact design
- High degree of ruggedness

1.2 Design of the devices

1.2.1 Interfaces and connections of Basic device

Interfaces Basic device

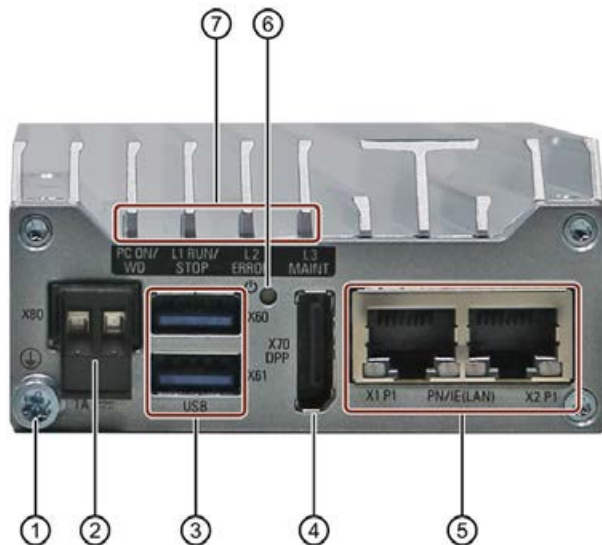

- ① Protective conductor connection
- ② Connection for a 24 VDC power supply
- ③ 2 x USB 3.0 port, high current
- ④ DisplayPort connection
- ⑤ 2 x RJ45 Ethernet connection X1 and X2 for 10/100/1000 Mbps
- ⑥ Power button
- ⑦ LEDs

The on/off button has three functions:

- Switch on the PC: Briefly press once
- Shut down operating system and switch off PC: Briefly press once
- Switch off PC without shutting down the operating system (hardware reset): Press for more than 4 seconds.

Note

The BIOS setup entry "After Power Failure" is preset to "Power On". This means the device is switched on with the on/off switch.

You then do not need to press the on/off button to switch it on.

1.2.2 Interfaces and connections of Extended device

Interfaces Extended device

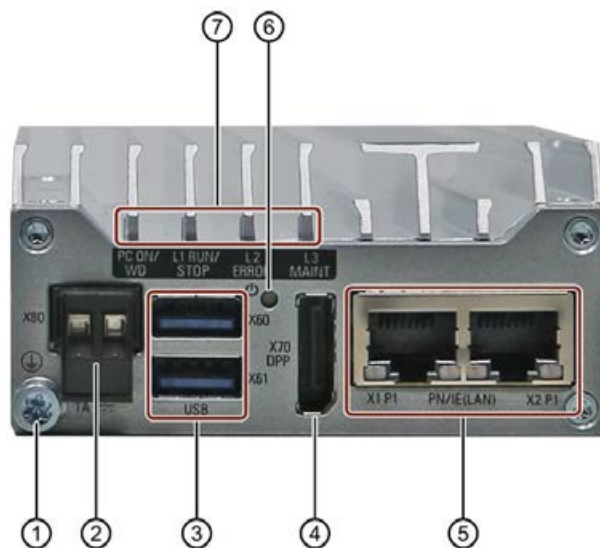

- ① Protective conductor connection
- ② Connection for a 24 VDC power supply
- ③ 2 x USB 3.0 port, high current
- ④ DisplayPort connection
- ⑤ 2 x RJ45 Ethernet connection X1 and X2 for 10/100/1000 Mbps
- ⑥ Power button
- ⑦ LED display

The on/off button has three functions:

- Switch on the PC: Briefly press once
- Shut down operating system and switch off PC: Briefly press once
- Switch off PC without shutting down the operating system (hardware reset): Press for more than 4 seconds.

Note

The BIOS setup entry "After Power Failure" is preset to "Power On". This means the device is switched on with the on/off switch.

You then do not need to press the on/off button to switch it on.

Additional connections Extended device



- ① RJ45 Ethernet connection X3 for 10/100/1000 Mbps
- ② 2 x USB 3.0 port, high current

1.2.3 Status displays of the devices



LED	State	Description
PC ON/WD	Off	-
	Green	BIOS ready to boot
	Flashing green/yellow (4 Hz)	BIOS in POST (Power On Self Test)
	Yellow	Idle state
	Flashing red (4 Hz)	Watchdog status display: active
L1 RUN/STOP	Off	-
	Green	Can be controlled by user program / control program
	Yellow	
L2 ERROR	Off	-
	Red	Can be controlled by user program / control program
	Yellow	
L3 MAINT	Off	-
	Yellow	Can be controlled by user program / control program
	Red	

Example programs for controlling the LEDs on Windows operating systems are available on the Customer Support page of Siemens Industry Automation and Drive Technologies. (<http://www.siemens.com/automation/service&support>)

1.3 Accessories

This chapter contains the scope of accessories valid at the time these operating instructions were written.

DIN rail	6AG4021-0AA20-0AA1
Wall mounting	6AG4021-0AA20-0AA2
Vertical mounting Basic device	6AG4021-0AA20-0AA3
Vertical mounting Extended device	6AG4021-0AA20-0AA4
Vertical mounting standard rail	6AG4021-0AA20-0AA5
Lithium battery	A5E44491494

Additional accessories can be found on the Internet at:

- Service & Support (<http://www.siemens.com/automation/service&support>)
- Expansion components and accessories (http://www.automation.siemens.com/mcms/pc-based-automation/en/industrial-pc/expansion_components_accessories)

Safety instructions

2.1 General safety instructions

 WARNING
The installer of the system is responsible for the safety of a system in which the device is integrated
There is a risk of malfunction which could result in death or serious injury.
<ul style="list-style-type: none">• Ensure that only suitably qualified personnel perform the work.

 WARNING
Life-threatening voltages are present with an open control cabinet
When you install the device in a control cabinet, some areas or components in the open control cabinet may be carrying life-threatening voltages.
If you touch these areas or components, you may be killed by electric shock.
Switch off the power supply to the cabinet before opening it.

System expansions

NOTICE
Damage through system expansions
Device and system expansions may be faulty and can affect the entire machine or plant.
The installation of expansions can damage the device, machine or plant. Device and system expansions may violate safety rules and regulations regarding radio interference suppression. If you install or exchange system expansions and damage your device, the warranty becomes void.

Battery

 WARNING
Risk of explosion and release of harmful substances Improper handling of lithium batteries can result in an explosion of the batteries. Explosion of the batteries and the released pollutants can cause severe physical injury. Worn batteries jeopardize the function of the device. Note the following when handling lithium batteries: <ul style="list-style-type: none">• Replace used batteries in good time; see the section "Replacing the backup battery" in the operating instructions.• Replace the lithium battery only with an identical battery or types recommended by SIEMENS (article number: A5E44491494).• Do not throw lithium batteries into fire, do not solder on the cell body, do not recharge, do not open, do not short-circuit, do not reverse polarity, do not heat above 100°C and protect from direct sunlight, moisture and condensation.

Strong high-frequency radiation

NOTICE
Observe immunity to RF radiation The device has an increased immunity to RF radiation according to the specifications on electromagnetic compatibility in the technical specifications. Radiation exposure in excess of the specified immunity limits can impair device functions, result in malfunctions and therefore injuries or damages. Read the information on immunity to RF radiation in the technical specifications.

ESD Guideline

Electrostatic sensitive devices can be labeled with an appropriate symbol.



NOTICE
Electrostatic sensitive devices (ESD) When you touch electrostatic sensitive components, you can destroy them through voltages that are far below the human perception threshold. If you work with components that can be destroyed by electrostatic discharge, observe the ESD Guideline (Page 64).

See also

Electromagnetic Compatibility, Industrial and Residential Areas (Page 63)

2.2 Industrial security

Siemens provides products and solutions with industrial security functions that support the secure operation of plants, systems, machines, and networks.

In order to protect plants, systems, machines and networks against cyber threats, it is necessary to implement – and continuously maintain – a holistic, state-of-the-art industrial security concept. Siemens' products and solutions only form one element of such a concept.

Customer is responsible to prevent unauthorized access to its plants, systems, machines and networks. Systems, machines and components should only be connected to the enterprise network or the internet if and to the extent necessary and with appropriate security measures (e.g. use of firewalls and network segmentation) in place.

Additionally, Siemens' guidance on appropriate security measures should be taken into account. For more information about industrial security, please visit:

<https://www.siemens.com/industrialsecurity>

Siemens' products and solutions undergo continuous development to make them more secure. Siemens strongly recommends that product updates are applied as soon as they are available and that the latest product versions are used. Use of product versions that are no longer supported, and failure to apply latest updates may increase customer's exposure to cyber threats.

To stay informed about product updates, subscribe to the Siemens Industrial Security RSS Feed under:

<https://www.siemens.com/industrialsecurity>

2.3 Notes on use

NOTICE
Possible functional restrictions in case of non-validated plant operation
The device is tested and certified on the basis of the technical standards. In rare cases, functional restrictions can occur during plant operation.
Validate the correct functioning of the plant to avoid functional restrictions.

Note**Use in an industrial environment without additional protective measures**

This device was designed for use in a normal industrial environment according to IEC 60721-3-3.

NOTICE
Cleaning
Clean the enclosure surface with a damp cloth and make sure that no water enters the device.

Mounting and connecting the device

3.1 Preparing for mounting

3.1.1 Checking the delivery package

Procedure

1. When accepting a delivery, please check the packaging for visible transport damage.
2. If any transport damage is present at the time of delivery, lodge a complaint at the shipping company in charge. Have the shipper confirm the transport damage immediately.
3. Unpack the device at its installation location.
4. Keep the original packaging in case you have to transport the unit again.

Note

Damage to the device during transport and storage

If a device is transported or stored without packaging, shocks, vibrations, pressure and moisture may impact the unprotected unit. A damaged packaging indicates that ambient conditions have already had a massive impact on the device.

The device may be damaged.

Do not dispose of the original packaging. Pack the device during transportation and storage.

5. Check the contents of the packaging for completeness and damage.

3.1 Preparing for mounting

6. If the contents of the packaging are incomplete, damaged or do not match your order, inform the responsible delivery service immediately. Fax the enclosed form "SIMATIC IPC/PG Quality Control Report".

NOTICE
Damaged device <ul style="list-style-type: none">• Make sure that the damaged device is not inadvertently installed and put into operation.• Label the damaged device and keep it locked away.• Send off the device for immediate repair.

NOTICE
Damage from condensation <p>If the device is subjected to low temperatures or extreme fluctuations in temperature during transportation, as is the case in cold weather, for example, moisture can build up on or inside the device (condensation).</p> <p>Moisture causes a short circuit in electrical circuits and damages the device.</p> <p>In order to prevent damage to the device, proceed as follows:</p> <ul style="list-style-type: none">• Store the device in a dry place.• Bring the device to room temperature before starting it up.• Do not expose the device to direct heat radiation from a heating device.• If condensation develops, wait approximately 12 hours or until the device is completely dry before switching it on.

7. Please keep the enclosed documentation in a safe place. It belongs to the device. You need the documentation when you commission the device for the first time.
8. Write down the identification data of the device.

3.1.2 Identification data of the device

The device can be clearly identified with the help of this identification data in case of repairs or theft.

Enter the identification data in the following table:

Article number	6AG4021-0A...-....
Serial number	S VP
Production version	FS
Windows "Product Key"	
Ethernet address 1 (MAC)	
Ethernet address 2 (MAC)	
Ethernet address 3 (MAC)	

You can find this information on the nameplate and COA label. The rating plate is located on the back panel of the device. The COA label is only available in pre-installed Windows operating systems and is affixed to the rear of the device.

Procedure

1. Transfer article number, serial number, production version (FS) and Ethernet addresses from the nameplate.

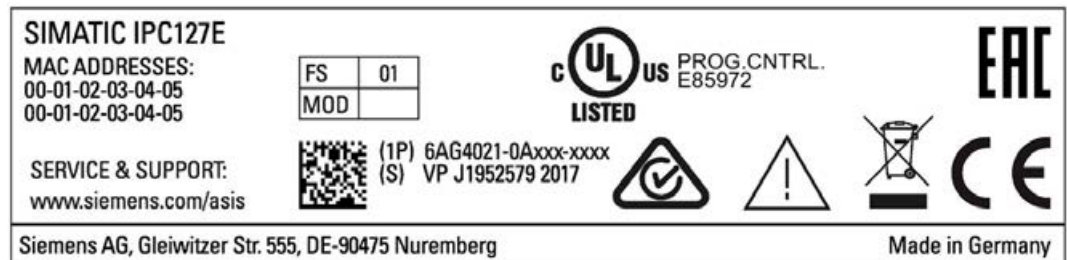

The Ethernet addresses can also be found in the BIOS Setup under "Main > Advanced > Peripheral Configuration" (see section "Technical Specifications").

Replacement device: The article number of a replacement device that can be briefly loaned out from the warehouse is listed on the nameplate.

Note

Replacement device without storage media

If you order a replacement device, remove the SSD from your device and insert it into the new device.

2. Transfer the Windows "Product Key" from the COA label.

Example of a COA label

Microsoft Windows "Product Key" of the "Certificate of Authenticity" (COA):
The COA label is only attached to the rear of the device when Windows® is installed.

- COA label of a device with operating system Windows® 10 Enterprise LTSC 2016, 64-bit, MUI (De, En, Fr, It, Sp)



3.1.3 Permitted mounting positions

The following mounting positions are permitted:



Observe the permitted temperature range for operation in the respective mounting position as defined in section "Technical specifications (Page 53)".

Ensure that the following clearances measurements to another component or to a wall of a housing are complied with:

- Below the device: ≥ 50 mm
- Above the device: ≥ 50 mm

3.2 Mounting the device

3.2.1 Mounting instructions

Note the following:

- The device is approved for operation in closed rooms only.
- For installation in a cabinet, observe the "Directives for interference-free installation of programmable logic controllers (<http://support.automation.siemens.com/WW/view/de/1064706>)" as well as the relevant DIN/VDE provisions and the applicable country-specific regulations.

Possible mounting types of the device:

- Mounting on a standard rail
- Wall mounting
- Upright mounting
- Vertical mounting standard rail

The mounting types are described in the following sections using the standard device as an example.

Position of the interfaces

The position of the interface side is determined by the mounting of the mounting bracket.

For mounting on a standard rail, the interface side of the device can point either up or down and to the right or to the left.

In the case of wall mounting, the interface side of the device can point up, down, to the left or to the right.

For vertical mounting, the interface side of the device can point either to the front (with Basic device only), up or down (Extended device).

Fasten securely

NOTICE
<p>Insufficient load carrying capacity</p> <p>If the mounting surface for wall and vertical mounting does not have sufficient load carrying capability, the device may fall down and be damaged.</p> <p>Ensure that the mounting surface on the wall can bear four times the total weight of the device, including fixing elements.</p>

NOTICE
<p>Incorrect fixing elements</p> <p>If you use anchors and screws other than those specified below for wall and vertical mounting, safe mounting is not guaranteed. The device can fall and may be damaged.</p> <p>Use only the anchors and screws specified in the following table.</p>

Material	Bore diameter	Fixing element
Concrete	Select according to the specification of the mounting elements used	<ul style="list-style-type: none"> Anchor, Ø 6 mm, 40 mm long Screw, Ø 4-5 mm, 40 mm long
Plasterboard, min. 13 mm thick		Toggle plug, Ø 12 mm, 50 mm long
Metal, min. 2 mm thick		<ul style="list-style-type: none"> Screw M4 × 15 M4 nut

3.2.2 Mounting on a standard rail

Mounting on a standard rail is suitable for horizontal and vertical mounting of the device.

Requirement

- A SIEMENS 35 mm standard rail TH35-15 conforming to EN 60715:2001
The standard rail is mounted.
- A standard rail bracket

Note

Only use the supplied screws for fastening the standard rail bracket. Longer screws can damage the inside of the device.

Tools

- A T10 screwdriver

Procedure for mounting

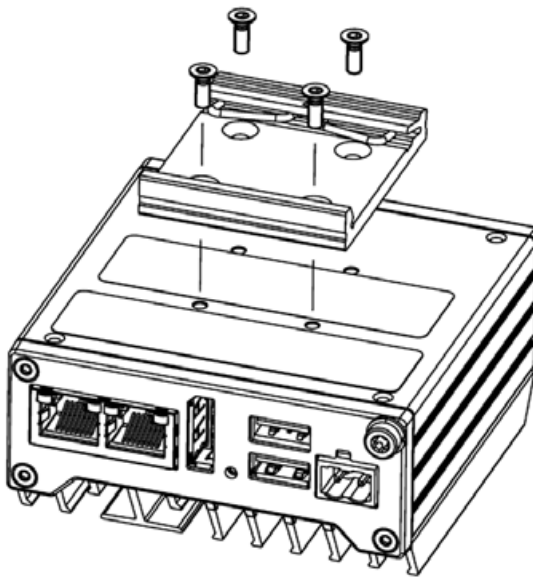

1. Lay the standard rail bracket on the rear of the device. Note the position of the spring of the standard rail bracket.
2. Fasten the standard rail bracket with the four supplied screws.
3. Place the device with the standard rail bracket onto the mounting rail from above. If the device is tilted when you place it down, the standard rail bracket does not grip.
4. Press the device down and toward the standard rail until the standard rail bracket engages.
5. Check whether the device is seated firmly on the standard rail.
6. For vertical mounting on a standard rail:
Fasten a standard rail ground terminal below the device.

Procedure for dismantling

1. Press the device down until the lower rail guide frees the device.
2. Swing the device out of the rails.
3. Remove the device from the rail.

See also

Dimension drawing basic device (Page 67)

Dimension drawing Extended device (Page 71)

3.2.3 Wall mounting

Wall mounting is suitable for horizontal mounting of the device.

Requirement

- Mounting bracket

Note

Only use the supplied screws for fastening the mounting bracket. Longer screws can damage the inside of the device.

- A T10 screwdriver
- Two anchors and two screws

Procedure for mounting

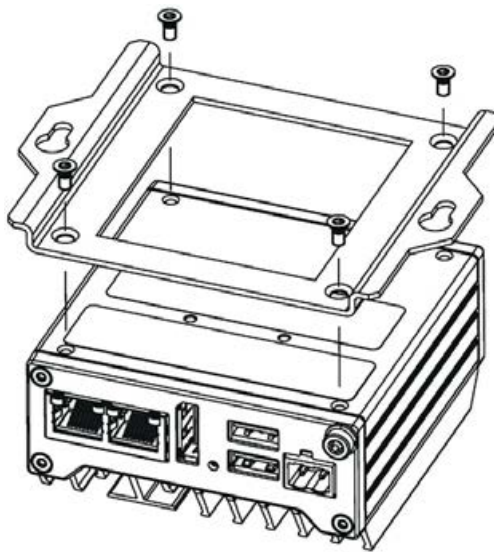

1. Mark the fixing holes on the mounting surface.
2. Drill the fixing holes.
3. Insert the anchors in the drilled holes.
4. Place the mounting bracket on the rear of the device. Note the orientation of the key-hole bore holes of the mounting bracket.
5. Fasten the mounting bracket with the four supplied screws.
6. Place the device with the mounting bracket onto the mounting surface.
7. Screw on the device.

See also

Dimension drawing basic device (Page 67)

Dimension drawing Extended device (Page 71)

3.2.4 Upright mounting

Upright mounting is suitable for vertical mounting of the device. The corresponding mounting bracket allows mounting that requires less space than standard rail mounting and wall mounting.

Requirement

- Mounting bracket

The mounting bracket is available in two versions - for the Standard and for the Extended device version.

Note

Only use the supplied screws for fastening the mounting bracket. Longer screws can damage the inside of the device.

- A T10 screwdriver
- Two anchors and two screws

Procedure – Vertical mounting

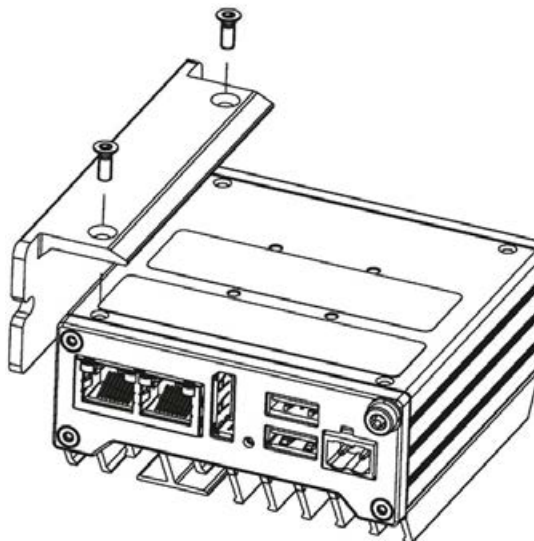

1. Place the mounting brackets onto the mounting surface.
2. Mark the fixing holes.
3. Drill the fixing holes.
4. Insert the anchors in the drilled holes.
5. Secure the mounting bracket with 2 screws.
6. Fasten the device to the mounting bracket with the two supplied screws.

See also

Dimension drawing basic device (Page 67)

Dimension drawing Extended device (Page 71)

3.2.5 Vertical mounting standard rail

Upright mounting on a standard rail is suitable for vertical mounting of the device. The corresponding mounting bracket allows mounting that requires less space than wall mounting.

Requirement

- Mounting bracket

Note

Only use the supplied screws for fastening the mounting bracket. Longer screws can damage the inside of the device.

- A T10 screwdriver
- Two anchors and two screws

Procedure – Vertical mounting standard rail

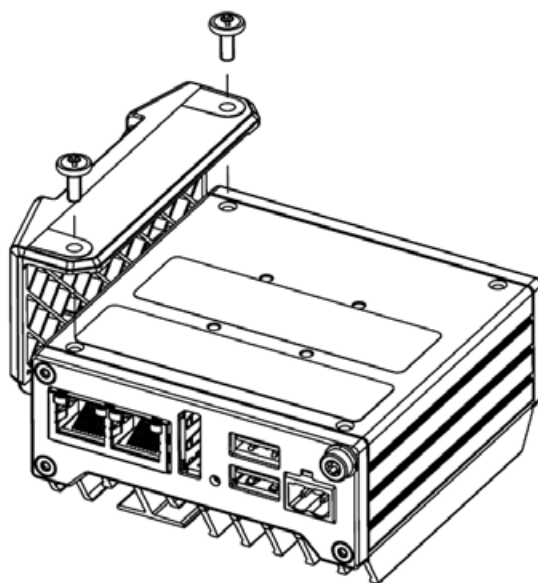

1. Place the mounting bracket on the rear of the device.
2. Fasten the mounting bracket with the two supplied screws.
3. Place the device with the mounting brackets onto the mounting rail.

3.3 Connecting the device

3.3.1 Notes on connecting

 WARNING
Risk of fire and electric shock The on/off switch does not isolate the device from the power supply. Risk of electric shock if the device is opened incorrectly or defective. There is also a risk of fire if the device or connecting lines are damaged. Death or serious bodily injury can result. You should therefore protect the device as follows: <ul style="list-style-type: none">• Always pull out the power plug when you are not using the device or if the device is defective. The power plug must be freely accessible.• Connect the device to a protective conductor as instructed (see "Connecting the protective conductor").• Use a central power isolating switch for cabinet installation.• When you install the device, make sure that the disconnecter is easily accessible.

 WARNING
Risk of lightning strikes A lightning flash may enter the mains cables and data transmission cables and jump to a person. Death, serious injury and burns can be caused by lightning. Take the following precautions: <ul style="list-style-type: none">• Disconnect the device from the power supply in good time when a thunderstorm is approaching.• Do not touch mains cables and data transmission cables during a thunderstorm.• Keep a sufficient distance from electric cables, distributors, systems, etc.

NOTICE
Fault caused by I/O devices The connection of I/O devices can cause faults in the device. The result may be personal injury and damage to the machine or plant. Note the following when connecting I/O devices: <ul style="list-style-type: none">• Read the documentation of the I/O devices. Follow all instructions in the documentation.• Only connect I/O devices which are approved for industrial applications in accordance with EN 61000-6-2 and IEC 61000-6-2.• I/O devices that are not hotplug-capable may only be connected after the device has been disconnected from the power supply.

NOTICE

Damage through regenerative feedback

Regenerative feedback of voltage to ground by a connected or installed component can damage the device.

Connected or built-in I/Os, for example, a USB drive, are not permitted to supply any voltage to the device. Regenerative feedback is generally not permitted.

3.3.2 Connecting the protective conductor

A connected protective conductor discharges dangerous electrical charges from the metal enclosure. The current flowing through the protective conductor when such a fault occurs triggers an upstream protective device that disconnects the machine from the power supply.

The protective conductor also improves the discharge of interference generated by external power cables, signal cables or cables for I/O modules to ground.

The connection for the protective conductor is labeled with the following symbol:



! WARNING

Electric shock and risk of fire

High voltage may be present in a defective device, which can cause fire or an electric shock if touched. Death and serious bodily injury can result.

- Connect the device to the protective conductor before you put it into operation.
- The PE terminal on the device must be connected to the protective conductor of the control cabinet or system in which the device is installed.
- Never operate the device without protective conductor.
- If a device is defective, remove it from operation without delay and label it accordingly.

Requirement

- T20 screwdriver
- Cable lug for M4
- Protective conductor with minimum cross-section of 2.5 mm²

Procedure



1. Clamp the cable lug on the protective conductor.
2. Firmly attach the cable lug to the protective conductor connection on the device using the M4 thread (see part labeled).
3. Connect the protective conductor to the protective conductor connection of the cabinet or the plant in which the device is installed.

3.3.3 Connecting the power supply

 **WARNING**

Safety regulations - connecting cable

Use only DC connecting cables which comply with the local safety regulations.

Otherwise, there is a risk of fire and electric shock. This can result in personal injury or property damage.

- Ensure that the DC connecting cables comply with the safety regulations of the country in which the device is installed and bear the marks required in each case.
- Connect the protective conductor in accordance with the operating instructions.

Note

IEC/EN/UL 61010

Note the following when you operate the device according to IEC/EN/UL 61010-2-201:

- The device may only be connected to a 24 V DC power supply that meets the requirements of safe extra-low-voltage (SELV/PELV) according to IEC/EN/UL 61010-2-201.
- In areas subject to UL/CSA 61010-2-201, the device must be supplied with NEC Class 2 according to UL/CSA 61010-2-201 or a limited-energy circuit according to UL/CSA 61010-1 during operation outside an enclosure.

Note

The 24 V DC power supply must be adapted to the input data of the device (see the technical specifications in the operating instructions).

Requirement

- The protective conductor is connected.
- You are using the supplied terminal.
- A two-core cable with a cable cross-section of 0.75 mm² to 2.5 mm² for the 24 V DC connection.
- A slotted screwdriver with a 3mm blade.

Procedure

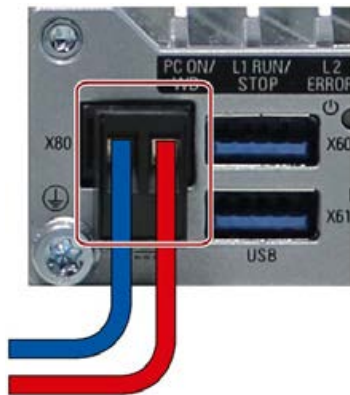
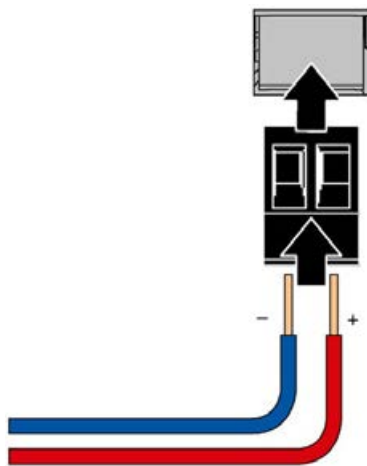

1. Switch off the 24 V DC power supply.
2. Connect the wires of the power supply as shown.
3. Insert the terminal at the indicated position.

3.3.4 Connecting the device to networks

The following options are available for integrating the device in existing or planned system environments and networks.

Ethernet

You can use the integrated Ethernet interfaces (10/100/1000 Mbps) for communication and data exchange with automation devices, e.g. SIMATIC S7.

You need suitable software to use this functionality: STEP 7, WinCC, WinAC, SIMATIC NET.

Industrial Ethernet

You can establish a network between the IPC and other devices via Industrial Ethernet. The on-board LAN interfaces are twisted-pair interfaces with data transmission rates of 10/100/1000 Mbps.

Note

You need a category 6 Ethernet cable for operation at 1000 Mbps.

PROFINET

PROFINET can be operated via:

- Standard Ethernet interfaces (RT)

SIMATIC NET

You can use this software package to create, operate and configure an innovative network for Field & Control level. The software package and the documentation are not included in the scope of delivery.

Additional information

You can find additional information on the Internet at: Technical support (<https://support.industry.siemens.com/cs/ww/en/>)

Commissioning the device and device functions

4.1 General information on commissioning

 CAUTION
Danger of burns The surface of some devices can reach temperatures of over 70 °C. These devices are identified with corresponding labels. <ul style="list-style-type: none">• Any unprotected contact may cause burns.• Avoid direct contact with the device during operation.• Touch the device only with appropriate protective gloves.

Requirement

- The device is connected to the power supply.
- The protective conductor is connected.
- The connection cables are plugged in correctly.
- The following hardware is available for initial commissioning:
 - One USB keyboard
 - One USB mouse
 - A monitor/display

4.2 Switching the device on/off

Following the initial startup, the operating system preinstalled on the drive is automatically configured on the device.

NOTICE
Faulty installation
Do not switch off the device during the entire installation process. Do not change the default values in the BIOS Setup.

Procedure - Switching on the device

1. The device starts as soon as 24 V are present.

Note:

The "PC ON/WD" LED lights up. The device carries out a self-test. During the self-test, the following message appears:

`Press Esc for Boot Options`

2. Wait for the message to disappear.
3. Follow the instructions on the screen.

Procedure - Switching off the device

To turn off the device, always select the function "Start > Shutdown".

Additional information

Information on your operating system can be found on the Internet:

- Microsoft® Windows® 10
(<https://support.industry.siemens.com/cs/ww/de/view/109749498/en?dl=en>)

4.3 Extended device functions

4.3.1 Monitoring functions

4.3.1.1 Overview of the monitoring functions

The basic version of the device also provides monitoring functions. The following display, monitoring and control functions are available when the appropriate software is used:

- Temperature monitoring (over-/undertemperature)
- Monitoring of drives with S.M.A.R.T. functionality
- Watchdog (hardware or software reset of the computer)
- Operating hours meter (information on total runtime)

SIMATIC IPC DiagBase software

Use the functions of the SIMATIC IPC DiagBase software included in the scope of delivery for local monitoring. Use the "DiagBase Management Explorer" application to obtain a clear overview of the controls. Use the DiagBase Alarm Manager to receive notifications about individual alarms.

Note

For more information on SIMATIC IPC DiagBase software functionality, please refer to the relevant Online Help.

SIMATIC IPC DiagMonitor software

SIMATIC IPC DiagMonitor is available on CD (not included in the scope of delivery). This monitoring software comprises:

- The software for the stations to be monitored.
- A library for creating user-specific applications.

4.3.1.2 Temperature monitoring/display

Temperature monitoring

Three temperature sensors monitor the temperature of the device at several positions:

- Processor temperature
- Temperature in proximity to the RAM ICs/blocks
- Temperature of the basic module

A temperature error is triggered when one of the three temperature values exceeds the set temperature threshold and the following reaction is initiated:

Reaction	Option
The DiagBase or DiagMonitor software is enabled	None

The temperature error is retained in memory until temperatures have fallen below the thresholds and it is reset by one of the following measures:

- Acknowledgment of the error message by the monitoring software
- Restart of the device

4.3.1.3 Watchdog (WD)

Configuration

You configure the watchdog with the DiagBase or DiagMonitor software.

Function

The watchdog is able to monitor system runtime and informs the user about the different reactions that are triggered if the system does not respond to the watchdog within the specified monitoring time.

A watchdog alarm is retained after a restart and is reset and logged by the DiagBase or DiagMonitor software. The watchdog configuration is retained in the process.

Watchdog reactions

The following reactions can occur if the watchdog is not addressed within the set time:

Option	Reaction
Reset on	Executes a hardware reset when the watchdog expires
Reset off	Executes no action when the watchdog expires
Restart	Restarts the operating system when the watchdog expires
Shutdown	Shuts down the operating system when the watchdog expires

NOTICE

"Reset on" option

The "Reset on" option immediately triggers a hardware reset that may result in loss of data under Windows and damage to the installation.

Watchdog monitoring times

The hardware supports the following times:

- Setting range from 1.2 s to 613.8 s; step width: 0.6 s; accuracy: ± 0.6 s

Set the monitoring times in SIMATIC Diagnostics Management as integer in the range from 4 to 64 seconds.

Note

Contact Customer Support for a detailed description of the Watchdog functions.

4.3.1.4 Battery monitoring

The installed backup battery has a limited service life, see section "Maintenance (Page 43)". A two-tier battery monitoring checks the status of the backup battery. The SIMATIC DiagBase and SIMATIC DiagMonitor diagnostic software determines the status of the backup battery.

When the first warning level is reached, the battery for buffering CMOS data still has a remaining service life of at least one month.

Device maintenance and repair

5.1 Maintenance

To maintain high system availability, we recommend the preventative replacement of those PC components that are subject to wear in accordance with the intervals for replacement indicated in the table below.

Component	Replacement interval:
SDD	Depending on the type of use *
CMOS backup battery	5 years

* The interval for replacement of the flash drives (SSD) depends greatly on the type of use. A specific interval cannot be given.

Note

All drives are monitored by SIMATIC DiagBase or SIMATIC DiagMonitor software via SMART status. As soon as the Smart status of the SSD goes to "Not OK", a message is generated in SIMATIC DiagBase or SIMATIC DiagMonitor or during a system start of the device. At this time, a data backup should be performed and the drive replaced.

5.2 Repair information

Carrying out repairs

Only qualified personnel are permitted to repair the device.

 **WARNING**

Unauthorized opening and improper repairs on the device may result in substantial damage to equipment or endanger the user.

- Always disconnect the power plug before you open the device.
- Only install system expansion devices designed for this device. If you install other expansion devices, you may damage the device or violate the safety requirements and regulations on RF suppression. Contact your technical support team or where you purchased your PC to find out which system expansion devices may be installed.

If you install or exchange system expansions and damage your device, the warranty and UL approval are voided.

 **CAUTION**

Electrostatic sensitive devices (ESD)

The device contains electronic components which are destroyed by electrostatic charges. This can result in malfunctions and damage to the machine or plant.

Make sure you take precautionary measures even when you open the device, for example, when opening device doors, device covers or the housing cover. For more information, refer to the chapter "ESD Guideline (Page 64)"

Limitation of liability

We are not liable for functional limitations caused by the use of third-party devices or components.

5.3 Replace the backup battery

Prior to replacement

 WARNING
Risk of explosion and release of harmful substances Improper handling of lithium batteries can result in an explosion of the batteries. Explosion of the batteries and the released pollutants can cause severe physical injury. Worn batteries jeopardize the function of the device. Note the following when handling lithium batteries: <ul style="list-style-type: none">• Replace the battery every 5 years.• Replace the lithium battery only with the type recommended by the manufacturer. The article number is A5E44491494.• Do not throw lithium batteries into fire, do not solder on the cell body, do not recharge, do not open, do not short-circuit, do not reverse polarity, do not heat above 100°C and protect from direct sunlight, moisture and condensation.

 CAUTION
Danger of burns The surface of some devices can reach temperatures of over 70 °C. These devices are identified with corresponding labels. <ul style="list-style-type: none">• Any unprotected contact may cause burns.• Avoid direct contact with the device during operation.• Touch the device only with appropriate protective gloves.

Note

Observe the local regulations relating to the disposal of used batteries.

Requirement

- The device has been removed.
- The device is disconnected from the power supply and all connecting cables have been unplugged.
- The device has cooled down.

Tools

You can change the battery with the following tools:

- T20 screwdriver
- T8 screwdriver
- Allen wrench, width across flats 1.5 mm

Removing the backup battery

NOTICE

Time may be deleted

The time will be deleted if it takes you longer than 30 seconds to replace the battery. The device is no longer synchronous. Time-controlled programs will no longer run or will run at the wrong time.

This may damage the plant.

- Reset the time for the device.

To remove the backup battery, follow these steps:

1. Remove the protective conductor connection.
2. Remove the screws on the two connection sides ③ and remove the covers.
3. Remove the threaded pin ① on the heat sink.

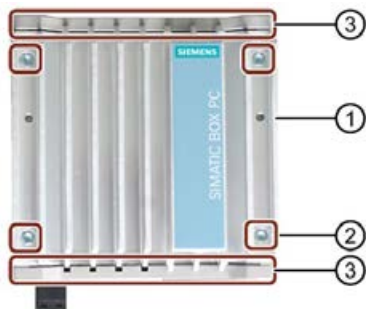

4. Remove the remaining screws ② on the heat sink.

5. Slide the heat sink out in the direction of the arrow, and rest the enclosure part on the cooling fins.

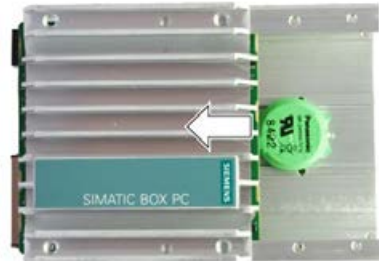

6. Pull out the connection plug of the battery cable.
7. Loosen the battery from the Velcro tape.

Installing the backup battery

To install the new backup battery, follow these steps:

1. Insert the new battery by placing it on the Velcro tape.



Note

Ensure that the cable connection is pointing in the direction of the printed-circuit board.

2. Fasten the cover of the housing side with the connections.
3. Turn the heat sink around and slide it on the bottom of the housing.

Note

Ensure that the EMC seal does not point up when sliding in the heat sink.

Make sure that the heat sink of the SSD when installed is once again resting on the housing bottom.

4. Insert the threaded screws on the heat sink.
5. Screw the heat sink into place.
6. Fasten the cover of the other housing side.
7. Install the protective conductor connection.

5.4 Replacing the SSD

Prior to replacement

 WARNING
Risk of explosion and release of harmful substances Improper handling of lithium batteries can result in an explosion of the batteries. Explosion of the batteries and the released pollutants can cause severe physical injury. Worn batteries jeopardize the function of the device. Note the following when handling lithium batteries: <ul style="list-style-type: none">• Replace the battery every 5 years.• Replace the lithium battery only with the type recommended by the manufacturer. The article number is A5E44491494.• Do not throw lithium batteries into fire, do not solder on the cell body, do not recharge, do not open, do not short-circuit, do not reverse polarity, do not heat above 100°C and protect from direct sunlight, moisture and condensation.

 CAUTION
Danger of burns The surface of some devices can reach temperatures of over 70 °C. These devices are identified with corresponding labels. <ul style="list-style-type: none">• Any unprotected contact may cause burns.• Avoid direct contact with the device during operation.• Touch the device only with appropriate protective gloves.

Note

Observe the local regulations relating to the disposal of used batteries.

Requirement

- The device has been removed.
- The device is disconnected from the power supply and all connecting cables have been unplugged.
- The device has cooled down.

Tools

You can change the battery with the following tools:

- T20 screwdriver
- T10 screwdriver
- T8 screwdriver
- Allen wrench, width across flats 1.5 mm

Removing the SSD

To remove the SSD, follow these steps:

1. Remove the protective conductor connection.
2. Remove the screws on the two connection sides ③ and remove the covers.
3. Remove the threaded pin ① on the heat sink.

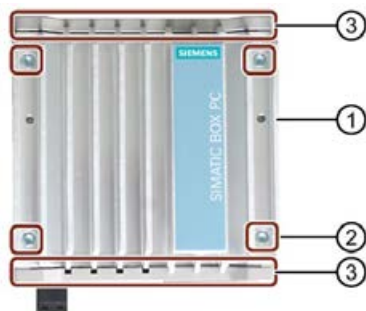

4. Remove the remaining screws ② on the heat sink.
5. Slide the heat sink out in the direction of the arrow, and rest the enclosure part on the cooling fins.

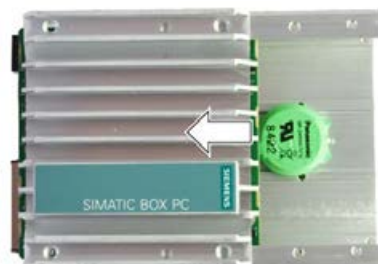

6. Remove the marked screw and carefully pull out the SSD from the plug in the direction of the arrow.

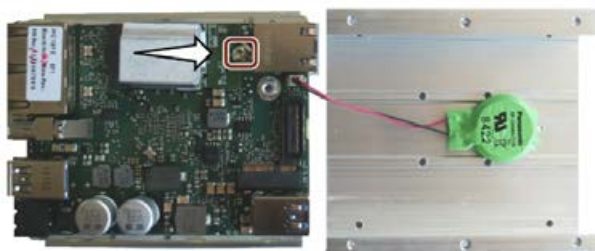

Installing the SSD

To install the new backup battery, follow these steps:

1. Place the heat sink ② on the SSD ①.

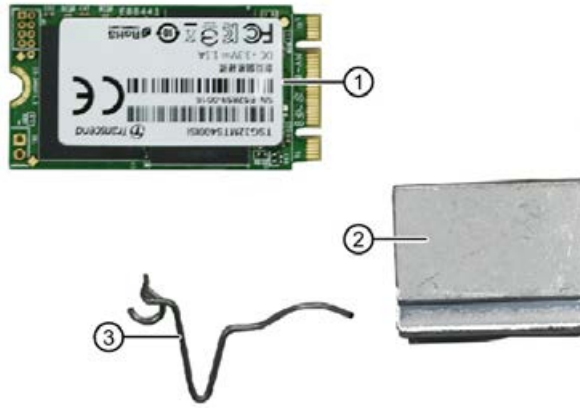

2. Insert the SSD including heat sink into the plug connector.
3. As shown in the figure, the heat sink must rest on the enclosure. Check the position of the heat sink by carefully sliding the module back into the enclosure. Correct the position of the heat sink, if necessary.

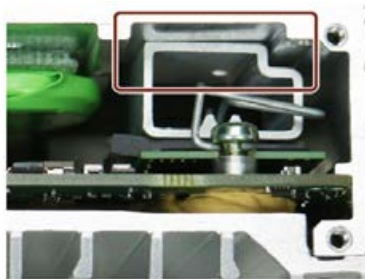

4. Position the spring ③ in the heat sink so that the ring-shaped part of the spring comes to rest above the screw sleeve; then fasten the SSD again with the screw.



5. Close the enclosure again. To do so, proceed in the reverse order of the removal.

5.5 Installing the software

5.5.1 Reinstalling the operating system

Information on installation of the operating system is available on the Internet and on the supplied USB stick:

- Microsoft® Windows® 10
(<https://support.industry.siemens.com/cs/ww/de/view/109749498/en?dl=en>)

5.5.2 Delivery state of the pre-installed software

5.5.2.1 Boot mode

Note

Setting Boot mode

We recommend that you restore the target system in the Boot mode that was set in the delivery state.

- Windows 10: UEFI Mode (UEFI = Unified Extensible Firmware Interface)
-

5.5.2.2 Partitions under Windows 10

Partitioning the hard disk or the SSD drive

For the **Windows 10 operating system (boots in UEFI mode (GPT data storage medium))**, the following partitions are set up in the delivery state:

Partition	Name	Size of data storage medium			File system
		32 GB	64 GB	128 GB	
First	SYSTEM	25 GB	40 GB	100 GB	NTFS (not compressed)
Second	DATA	Remainder	Remainder	Remainder	NTFS (not compressed)

5.6 Backing up data

We recommend the software tool **SIMATIC IPC Image & Partition Creator** (as of V3.4) to back up data under Windows. This tool provides convenient and efficient functions for backing up and restoring the full content of memory cards, hard disks and individual partitions (images).

The **SIMATIC IPC Image & Partition Creator** can be ordered using the Siemens online ordering system (<https://mall.industry.siemens.com>). For more information about SIMATIC IPC Image & Partition Creator, refer to its product documentation.

5.7 Configuring firmware/BIOS

You can find information on configuring firmware/BIOS and on the firmware settings in the delivery state in the "Firmware/BIOS description (<https://support.industry.siemens.com/cs/ww/en/view/109762673>)".

Note

If your IPC no longer boots, e.g. due to a crash during a BIOS update, contact your local SIEMENS contact person.

5.8 Recycling and disposal

The devices described in these operating instructions can be recycled thanks to their low level of pollutants. Observe the local statutory requirements for environmentally sound recycling and disposal of your old devices. Alternatively, you can use a certified disposal service company.

Technical specifications

6.1 General technical specifications

General technical specifications

Article number	See order documents
Weight without mounting brackets	<ul style="list-style-type: none"> • Standard: Approx. 320 g • Extended: Approx. 400 g
Supply voltage	24 V DC (19.2 to 28.8 V)
Transient voltage interruption	Up to 5 ms buffer time at full load Max. 10 events per hour; recovery time at least 1 s
Current consumption	max. 1.8 A at 24 V
Noise emission	< 40 dB(A) according to DIN 45635-1
Degree of protection	IP 40 in accordance with IEC 60529
Protection class	Protection class I in accordance with IEC 61140
Degree of pollution	Device is designed for environments with pollution degree 2
Quality assurance	In accordance with ISO 9001

Note

Note the following when you operate the device according to IEC/EN/UL 61010-2-201:

- The device may only be connected to a 24 V DC power supply that meets the requirements of safe extra-low-voltage (SELV/PELV) according to IEC/EN/UL 61010-2-201.
- In areas subject to UL / CSA 61010-2-201, the device must be supplied with NEC Class 2 according to UL / CSA 61010-2-201 or a limited-energy circuit according to UL / CSA 61010-1 during operation outside an enclosure.

6.1 General technical specifications

Electromagnetic compatibility

Immunity with regard to conducted interference on the supply lines	± 2 kV according to IEC 61000-4-4; burst ± 0.5 kV according to IEC 61000-4-5; surge symmetrical ± 1 kV according to IEC 61000-4-5; surge asymmetrical
Noise immunity on signal lines	± 1 kV to IEC 61000-4-4; Burst; Length < 3 m ± 2 kV in accordance with IEC 61000-4-4; Burst; length > 3 m ± 2 kV in accordance with IEC 61000-4-5; Surge; length > 30 m
Immunity to discharges of static electricity	± 6 kV contact discharge in accordance with IEC 61000-4-2 ± 8 kV air discharge in accordance with IEC 61000-4-2
Immunity to RF interference	10 V/m, 80 ... 2 GHz, 80% AM according to IEC 61000-4-3 3 V/m, 2 ... 6 GHz, 80% AM according to IEC 61000-4-3 10 V, 10 KHz ... 80 MHz, 80% AM according to IEC 61000-4-6
Magnetic field	100 A/m, RMS value 50/60 Hz in accordance with IEC 61000-4-8

Main circuit board

Processor / main memory	<ul style="list-style-type: none"> • Intel Atom E3930, 2 cores/2 threads, 2 GB RAM • Intel Atom E3940, 4 cores/4 threads, 4 GB RAM • Intel Atom E3930, 2 cores/2 threads, 2 GB RAM; TPM • Intel Atom E3940, 4 cores/4 threads, 4 GB RAM; TPM • LPDDR4 memory
-------------------------	---

Drive, memory medium

Solid State Drive	<ul style="list-style-type: none"> • 32 GB SSD • 64 GB SSD • 128 GB SSD
Floppy and CD-ROM drive	External, can be connected via USB port ¹
USB stick	External, can be connected via USB port

¹ Only to device USB port, not via USB hub

Graphics

Graphics controller	Integrated Graphic Controller
Graphics memory	Up to 512 MB, shared memory
Resolution, graphics memory	<ul style="list-style-type: none"> • DisplayPort resolution: 640 × 480 pixels to 4096 × 2160 pixels • Up to 512 MB graphics memory is taken from main memory, UMA, dynamic

Ports

USB (5 V; 900 mA)	2 × USB 3.0, high current a maximum of 1 high current can be operated Extended device additionally: 2 × USB 3.0, high current You can find additional information in the section "Power demand of the components (Page 57)".
LAN interface X1 P1, RJ45 ¹	Intel LAN Controller Springville i210 10, 100, 1000 Mbps, teaming ²
LAN interface X2 P1, RJ45 ¹	
LAN interface X3 P1, RJ45 ¹ (Extended device)	
Monitor	Can be connected via DisplayPort
Keyboard, mouse	Connection via USB port

¹ For unique labeling, the LAN interfaces are numbered on the enclosure. The numbering by the operating system can differ.

² Teaming can be set and initiated in the configuration interface. In teaming operation, jumbo frames, e.g. for the camera application, are not supported.

6.2 Ambient conditions

Climatic ambient conditions

The temperature values have been checked in accordance with IEC 60068-2-1, IEC 60068-2-2 and IEC 60068-2-14. For permissible mounting positions, see "Permitted mounting positions (Page 23)".

Operation	<p>Standard mounting position (interfaces top / bottom)</p> <ul style="list-style-type: none"> • CPU Intel Atom E3930: 0 °C to 50 °C / 55 °C * • CPU Intel Atom E3940: 0 °C to 45 °C / 50 °C * <p>Vertical mounting (interface front; Basic device) / Wall mounting or mounting on a standard rail (interfaces on side) / Vertical mounting standard rail (interfaces top / bottom)</p> <ul style="list-style-type: none"> • CPU Intel Atom E3930: 0 °C to 45 °C / 50 °C * • CPU Intel Atom E3940: 0 °C to 40 °C / 45 °C * <p>Basic device: Vertical mounting standard rail (interfaces front)</p> <ul style="list-style-type: none"> • CPU Intel Atom E3930: 0 °C to 35 °C / 40 °C * • CPU Intel Atom E3940: 0 °C to 35 °C / 40 °C *
Storage/transport	-20 ... +60 °C
Gradient	<ul style="list-style-type: none"> • Operation: Max. 10 °C/h • Storage: 20 °C/h, no condensation
Relative humidity	<p>Tested in accordance with IEC 60068-2-78, IEC 60068-2-30</p> <ul style="list-style-type: none"> • Operation: 5 ... 85 % at 30 °C, no condensation • Storage/transport: 5 ... 95 % at 25/55 °C, no condensation
Barometric pressure	<ul style="list-style-type: none"> • Operation/storage/transport: 1080 to 660 hPa, corresponds to an elevation of -1000 to 3500 m

* BIOS Power switch set to "High temperature" and USB load max. 1 W.

Mechanical ambient conditions

Vibration resistance	Tested in accordance with IEC 60068-2-6
Operation	With wall or vertical mounting: <ul style="list-style-type: none"> • 5 to 9 Hz: 3.5 mm • 9 to 500 Hz: 9.8 m/s² With standard mounting rail or vertical standard mounting rail: <ul style="list-style-type: none"> • 10 ... 58 Hz: 0.0375 mm • 58 ... 200 Hz: 4.9 m/s²
Storage/transport	<ul style="list-style-type: none"> • 5 to 9 Hz: 3.5 mm • 9 to 500 Hz: 9.8 m/s²
Impact resistance	Tested in accordance with IEC 60068-2-27
Operation	150 m/s ² , 11 ms
Storage/transport	250 m/s ² , 6 ms

6.3 Power demand of the components

Maximum power consumption of the auxiliary components

Auxiliary components		Maximum permitted power consumption +5 V	Max. total power
USB device 3.0	High current	900 mA	5 W (for all USB devices)

Note

Device can overheat!

The power supply cannot make unlimited power available. The auxiliary components consume energy and produce heat.

The device may overheat. The auxiliary components will be damaged.

6.4 Direct current supply (DC)

Technical specifications

Input voltage	24 VDC (19.2 to 28.8 VDC)
Protection class	Safety class I (A protective conductor must be connected to the device)

Typical power consumption

	Power consumption (at 24 V rated voltage)
Basic device with Intel Atom E3930	13 W
Basic device with Intel Atom E3940	15 W
Extended device with Intel Atom E3930	13 W
Extended device with Intel Atom E3940	15 W

See also

Power demand of the components (Page 57)

Certificates and approvals

7.1 CE marking



The device meets the guidelines listed in the following sections.

EU Declaration of Conformity

The associated declaration of conformity is available on the Internet at the following address:
 EC Declaration of Conformity, UL approval Canada/USA
<http://support.automation.siemens.com/WW/view/en/48958203>.

7.2 DIN ISO 9001 certificate and software license agreements

DIN ISO 9001 certificate

The Siemens quality management system for all production processes (development, production and sales) meets the requirements of DIN ISO 9001:2000.

This has been certified by DQS (the German society for the certification of quality management systems).

Certificate registration no. DE-000656 QM08

Software license agreements

If the device is supplied with preinstalled software, you must observe the corresponding license agreements.

7.3 UL61010 approval

UL approval



The following approvals are available for the device when specified as such on the nameplate:

- Underwriters Laboratories (UL) according to Standard UL 61010-2-201 Second Edition, File E85972 (PROG.CNTRLR.)
- Canadian National Standard CAN/CSA-C22.2 No. 61010-2-201 Second Edition

7.4 FCC (USA) compliance

USA	
Federal Communications Commission Radio Frequency Interference Statement	This equipment has been tested and found to comply with the limits for a Class A digital device, pursuant to Part 15 of the FCC Rules. These limits are designed to provide reasonable protection against harmful interference when the equipment is operated in a commercial environment. This equipment generates, uses, and can radiate radio frequency energy and, if not installed and used in accordance with the instruction manual, may cause harmful interference to radio communications. Operation of this equipment in a residential area is likely to cause harmful interference in which case the user will be required to correct the interference at his own expense.
Shielded Cables	Shielded cables must be used with this equipment to maintain compliance with FCC regulations.
Modifications	Changes or modifications not expressly approved by the manufacturer could void the user's authority to operate the equipment.
Conditions of Operations	This device complies with Part 15 of the FCC Rules. Operation is subject to the following two conditions: (1) this device may not cause harmful interference, and (2) this device must accept any interference received, including interference that may cause undesired operation.

Responsible party for Supplier's Declaration of Conformity

Siemens Industry, Inc.
 Digital Factory - Factory Automation
 5300 Triangle Parkway, Suite 100
 Norcross, GA 30092
 USA
 mailto: amps.automation@siemens.com ([mailto: amps.automation@siemens.com](mailto:amps.automation@siemens.com))

7.5 Canada

CANADA	
Canadian Notice	This Class B digital apparatus complies with Canadian ICES-003 (B).
Avis Canadien	Cet appareil numérique de la classe B est conforme à la norme NMB-003 (B) du Canada.

7.6 Australia

RCM AUSTRALIA/NEW ZEALAND



This product meets the requirements of EN 61000-6-3 Generic standards - Emission standard for residential, commercial and light-industrial environments.

This product meets the requirements of the standard EN 61000-6-3 Generic standards - Emission standard for residential, commercial and light-industrial environments.

7.7 Eurasian Customs Union EAC

Identification for Eurasian Customs Union



- EAC (Eurasian Conformity)
- Customs union of Russia, Belarus and Kazakhstan
- Declaration of conformity according to Technical Regulations of the Customs Union (TR CU)

7.8 Korea

KOREA



The following approvals are available for the device when specified as such on the nameplate:

The following approvals are available for the device when specified as such on the nameplate:

如果在铭牌上给出了以下相关信息，则表示设备已获得以下认证：

This product meets the requirements of Korean certification.

This product satisfies the requirement of the Korean Certification (KC Mark).

이 기기는 업무용(A급) 전자파 적합기기로서 판매자 또는 사용자는 이 점을 주의하시기 바라며 가정 외의 지역에서 사용하는 것을 목적으로 합니다.

Directives and declarations

8.1 Electromagnetic Compatibility, Industrial and Residential Areas

Electromagnetic compatibility

This product meets the requirements of EU Directive 2014/30/EU "Electromagnetic Compatibility".

The device is designed for the following areas of application corresponding to the CE marking:

Scope of application	Requirements for	
	Interference emission	Immunity to interference
Industrial area	EN 61000-6-4	EN 61000-6-2
Residential and commercial areas and small businesses	EN 61000-6-3	EN 61000-6-1

2011/65/EU "Restriction of the use of certain hazardous substances in electrical and electronic equipment" (RoHS Directive)

8.2 ESD guideline

What does ESD mean?

An electronic module is equipped with highly integrated components. Due to their design, electronic components are highly sensitive to overvoltage and thus to the discharge of static electricity. Such electronic components or modules are labeled as electrostatic sensitive devices.

The following abbreviations are commonly used for electrostatic sensitive devices:

- ESD – Electrostatic sensitive device
- ESD – Electrostatic Sensitive Device as a common international designation

Electrostatic sensitive devices can be labeled with an appropriate symbol.



NOTICE

Damage to ESD from touch

Electrostatic sensitive devices, ESD, can be destroyed by voltages which are far below the human perception limit. If you touch a component or electrical connections of a module without discharging any electrostatic energy, these voltages may arise.

The damage to a module by an overvoltage can often not be immediately detected and only becomes evident after an extended period of operation. The consequences are incalculable and range from unforeseeable malfunctions to a total failure of the machine or system.

Avoid touching components directly. Make sure that persons, the workstation and the packaging are properly grounded.

Charge

Every person without a conductive connection to the electrical potential of his/her surroundings can be electrostatically charged.

The material with which this person comes into contact is of particular significance. The figure shows the maximum electrostatic voltages with which a person is charged, depending on humidity and material. These values conform to the specifications of IEC 61000-4-2.

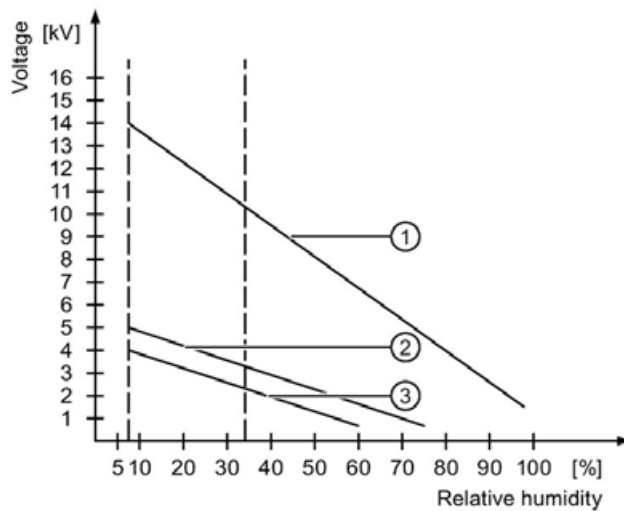

- ① Synthetic materials
- ② Wool
- ③ Antistatic materials such as wood or concrete

NOTICE

Grounding measures

There is no equipotential bonding without grounding. An electrostatic charge is not discharged and may damage the ESD.

Protect yourself against discharge of static electricity. When working with electrostatic sensitive devices, make sure that the person and the workplace are properly grounded.

Protective measures against discharge of static electricity

- Disconnect the power supply before you install or remove modules which are sensitive to ESD.
- Pay attention to good grounding:
 - When handling electrostatical sensitive devices, make sure that persons, the workstation and devices, tools and packaging used are properly grounded. This way you avoid static discharge.
- Avoid direct contact:
 - As a general rule, do not touch electrostatic sensitive devices, except in the case of unavoidable maintenance work.
 - Hold the modules at their edge so that you do not touch the connector pins or conductor paths. This way, the discharge energy does not reach and damage the sensitive components.
 - Discharge your body electrostatically before you take a measurement at a module. Do so by touching grounded metallic parts. Always use grounded measuring instruments.

Dimension drawings

9.1 Dimension drawing basic device

Note

The fixing holes on the device are arranged symmetrically. The fixing parts can be arranged to meet your requirements in any orientation of the device.

Mounting on a standard rail

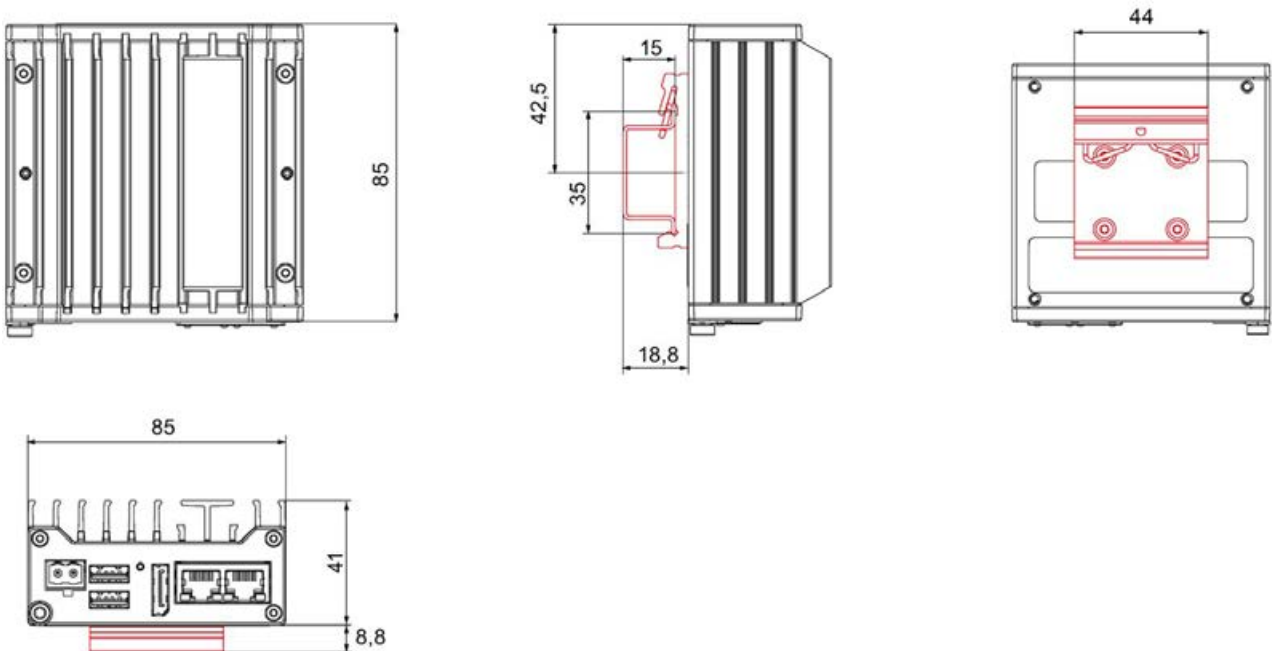

All dimensions in mm

Vertical mounting standard rail

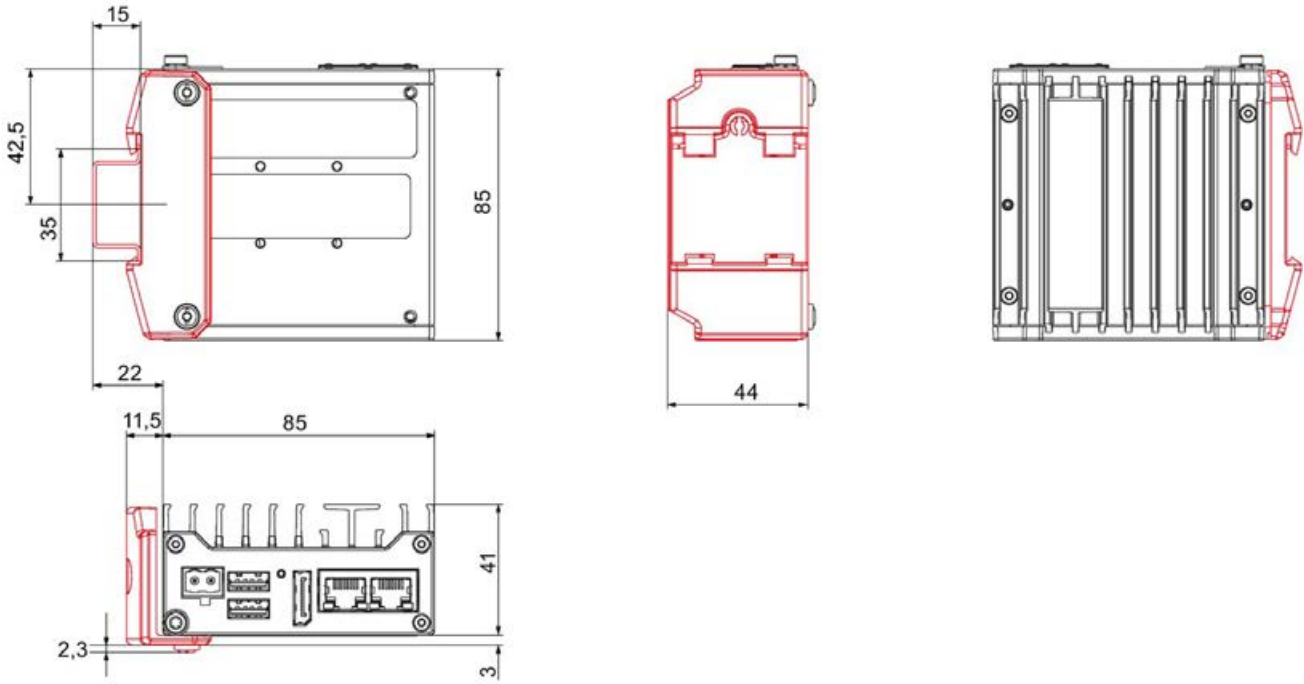

All dimensions in mm

Wall mounting

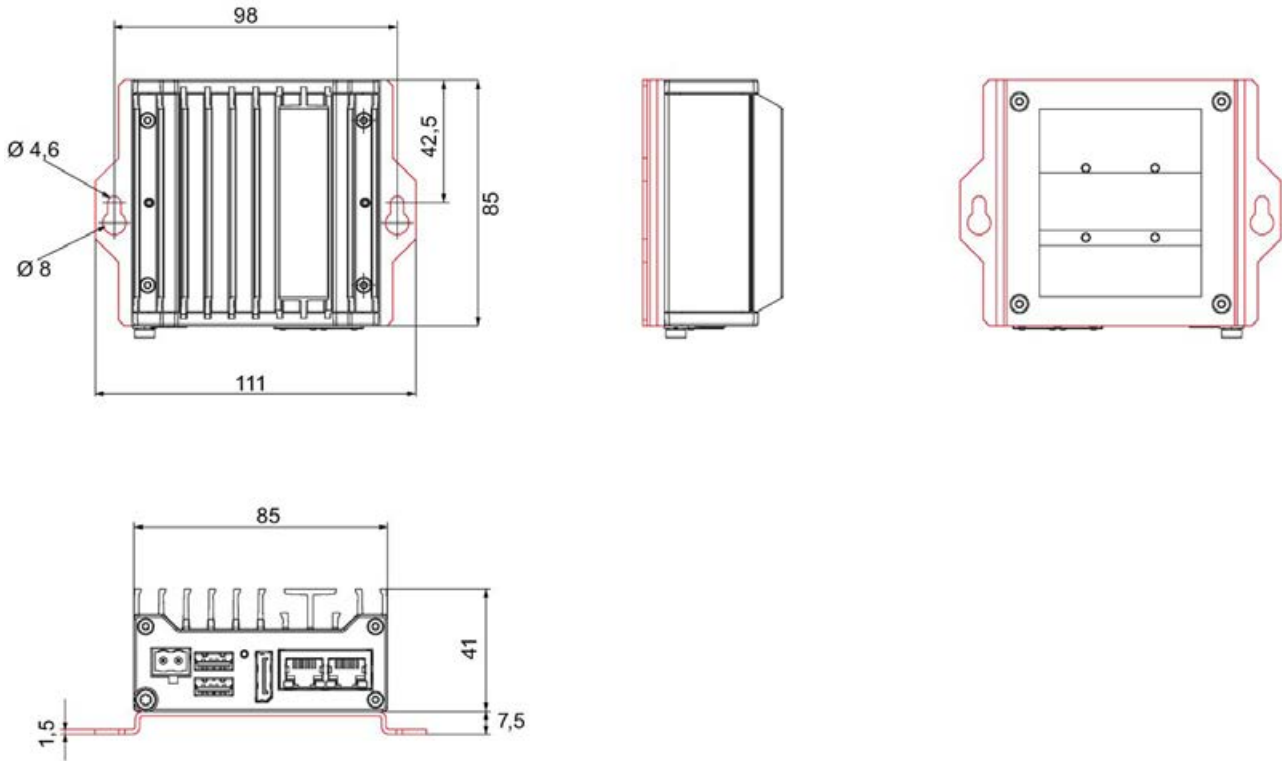

All dimensions in mm

Upright mounting

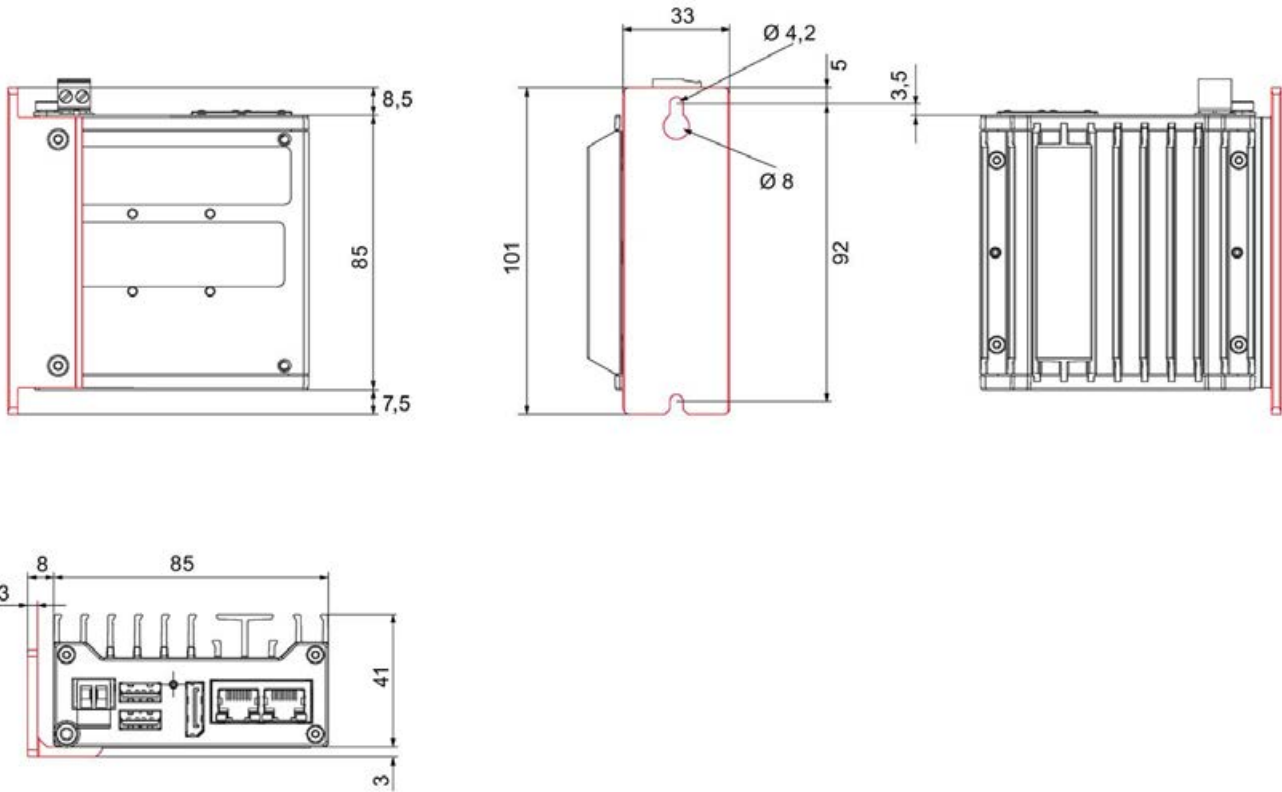

All dimensions in mm

9.2 Dimension drawing Extended device

Note

The fixing holes on the device are arranged symmetrically. The fixing parts can be arranged to meet your requirements in any orientation of the device.

Mounting on a standard rail

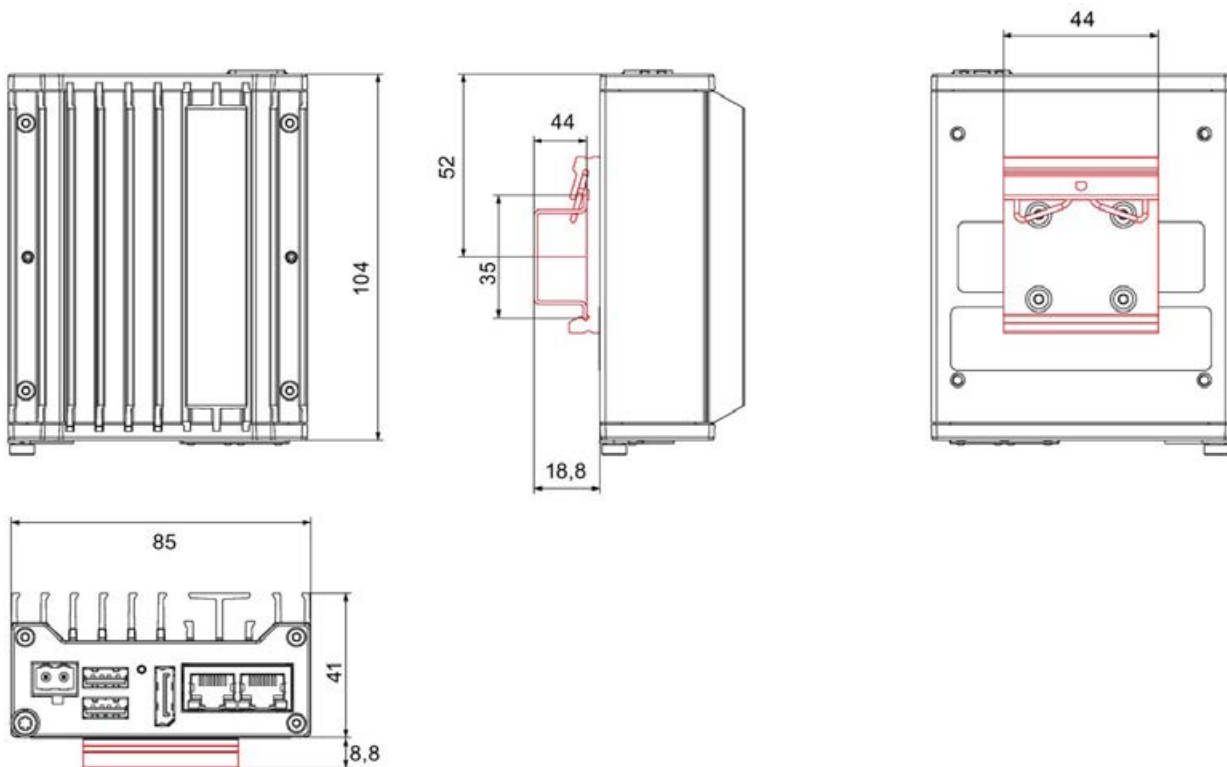

All dimensions in mm

Vertical mounting standard rail

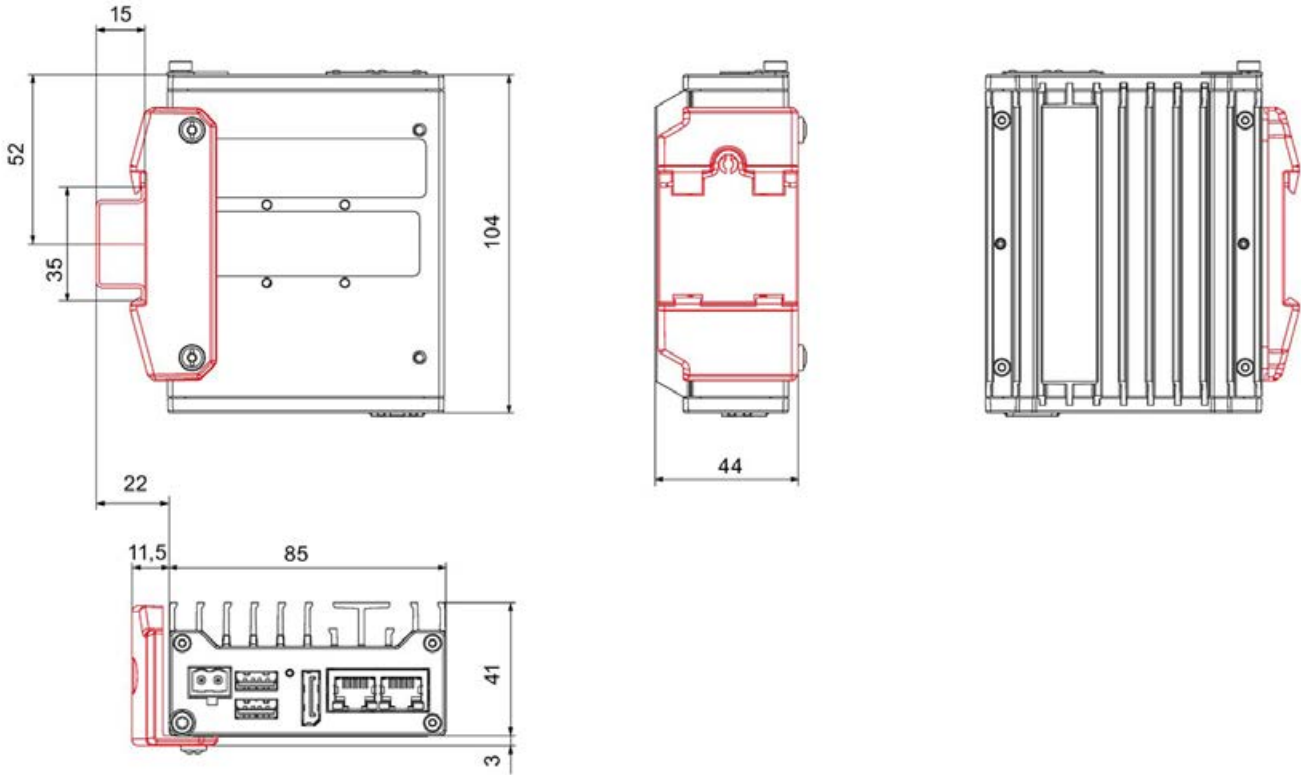

All dimensions in mm

Wall mounting

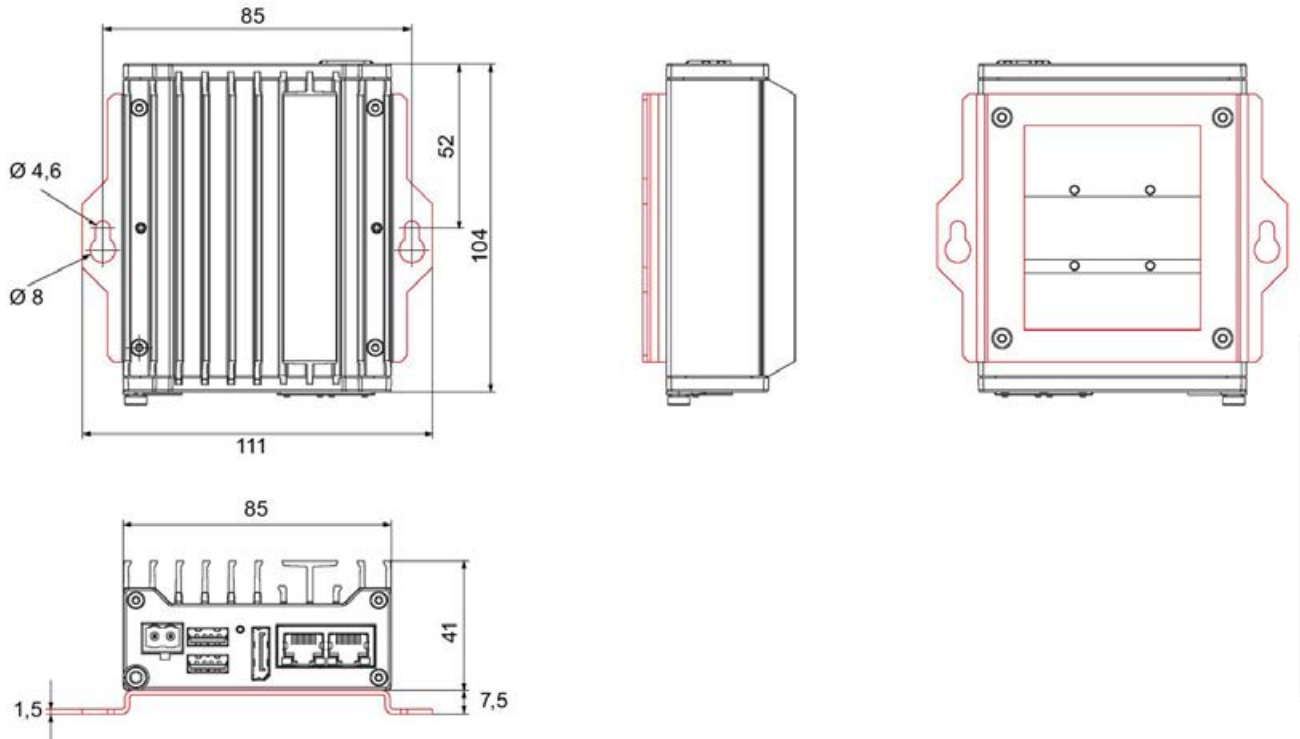

All dimensions in mm

Upright mounting

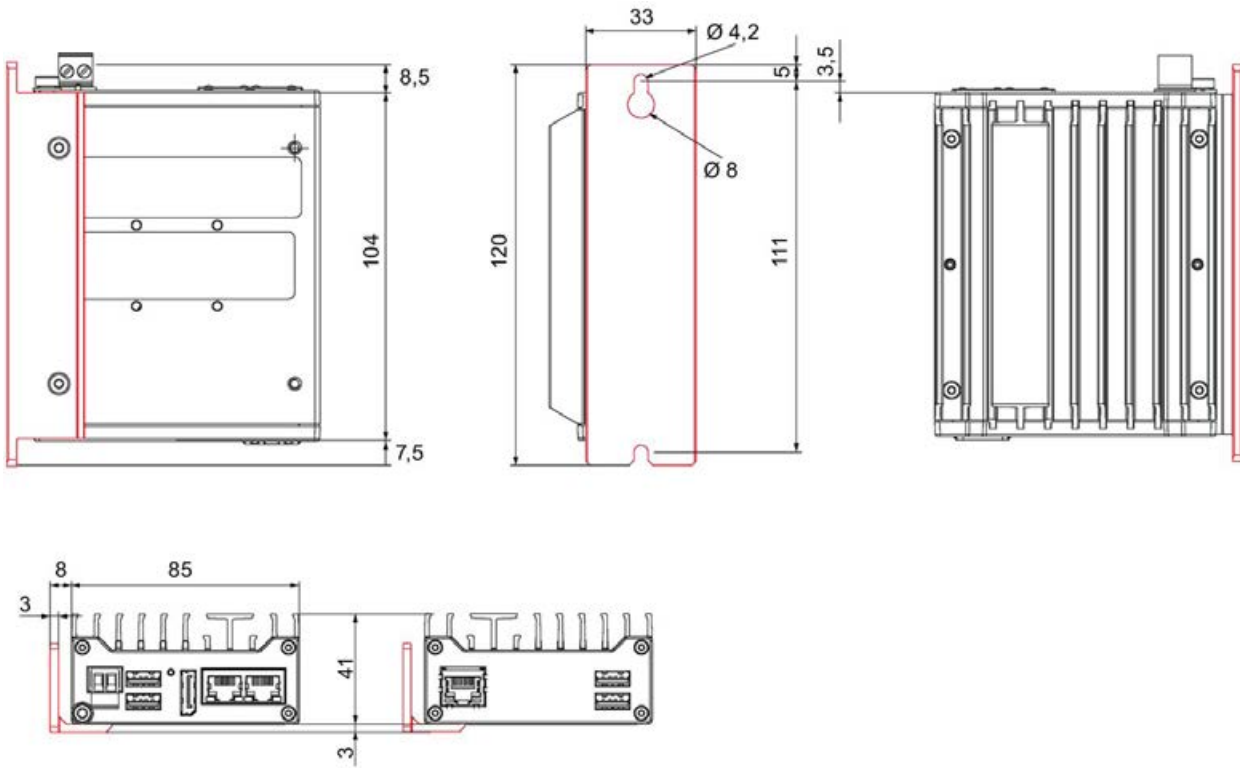

All dimensions in mm

Hardware description

10.1 Technical features of the motherboard

Component / port	Description	Parameters
Chipset	integrated in CPU	
BIOS	Core, Video, ACPI	
CPU	Intel Atom	
Memory	LPDDR4	2 GB, 4 GB
Graphics	Integrated graphics	up to 512 MB graphics memory taken dynamically from RAM

10.2 External interfaces

10.2.1 Overview of interfaces

Interface	Position	Description (Basic / Extended device)	
USB	External	2 / 4 USB channels	2 / 4 × USB 3.0
Ethernet	External	2 x RJ45 / 3 x RJ45	10/100/1000 Mbps
DisplayPort	External	DP	

10.2.2 USB 3.0 port

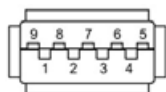

Pin	Short name	Meaning	Input / output
1	VBUS	+ 5 V (fused)	Output
2	D-	Data channel USB2	Input / output
3	D+	Data channel USB2	Input / output
4	GND	Ground	–
5	RX-	Data channel USB3	Input
6	RX+	Data channel USB3	Input
7	GND	Ground	–
8	TX-	Data channel USB3	Output
9	TX+	Data channel USB3	Output

10.2.3 DisplayPort

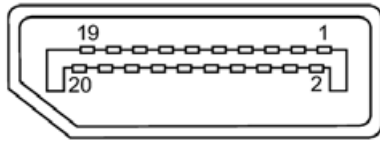

Pin	Short name	Meaning	Input / output
1	ML_Lane0+	DP data 0+	Output
2	GND	Ground	-
3	ML_Lane0-	DP data 0-	Output
4	ML_Lane1+	DP data 1+	Output
5	GND	Ground	-
6	ML_Lane1-	DP data 1-	Output
7	ML_Lane2+	DP data 2+	Output
8	GND	Ground	-
9	ML_Lane2-	DP data 2-	Output
10	ML_Lane3+	DP data 3+	Output
11	GND	Ground	-
12	ML_Lane3-	DP data 3-	Output
13	CONFIG1 CAD	Cable Adapter Detect	Input
14	CONFIG2	Ground (PullDown)	-
15	AUX_CH+	Auxiliary channel+	Bidirectional
16	GND	Ground	-
17	AUX_CH-	Auxiliary channel-	Bidirectional
18	HPD	Hot Plug Detect	Input
19	GND	Ground	-
20	DP_PWR	+3.3V (fused)	Output

10.2.4 Ethernet port

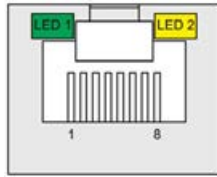

Pin	Short description	Meaning
1	BI_DA+	Bidirectional data A+, input/output
2	BI_DA-	Bidirectional data A-, input/output
3	BI_DB+	Bidirectional data B+, input/output
4	BI_DC+	Bidirectional data C+, input/output
5	BI_DC-	Bidirectional data C-, input/output
6	BI_DB-	Bidirectional data B-, input/output
7	BI_DD+	Bidirectional data D+, input/output
8	BI_DD-	Bidirectional data D-, input/output

LED	Short description	Meaning
1	LED 1	Off: 10 Mbps Lit green: 100 Mbps Lit orange: 1000 Mbps
2	LED 2	Lit orange: Connection established Flashes: Activity

10.3 System resources

10.3.1 Currently allocated system resources

All system resources (hardware addresses, memory utilization, interrupt assignment, DMA channels) are assigned dynamically by the Windows operating system, depending on the hardware equipment, drivers and connected external devices. You can view the current allocation of system resources or possible conflicts in the Control Panel.

Procedure

To view the system resources, proceed as follows:

1. Select "Start" in the Windows Start menu.
2. Enter "msinfo32" in the search box and confirm with the ENTER key.

10.4 Input/output address areas

10.4.1 Overview of the internal module registers

The following addresses are used for the internal registers:

Addresses	Input/output unit
I/O 0x460..0x473h	Watchdog register
I/O ¹	Output register LED 1/2/3 and Watchdog LED
I/O ¹	Battery status register (read only)

¹ See MMIO GPIO addresses for LEDs and battery monitoring (Page 82)

10.4.2 Watchdog register

Excerpt from Intel® technical specifications

TCO IO Register

ACPI IO Base Address= 0x400

TCO Register = ACPI IO Adr + TCO Offset

Offset Start	Offset End	Register Name (ID) - Offset	Default Value
60h	63h	TCO Reload Register (TCO_RLD) - Offset 60h	0h
64h	67h	TCO Timer Status (TCO_STS) - Offset 64h	0h
68h	69h	TCO Timer Control (TCO1_CNT) - Offset 68h	0h
70h	73h	TCO Timer Register (TCO_TMR) - Offset 70h	40000h

TCO Reload Register (TCO_RLD) - Offset 60h

Bit Range	Default & Access	Field Name (ID): Description
31:10	0h RO	Reserved (rsvd): Reserved.
9:0	0h RO/V	TCO Timer Value (tco-val): Reading this register will return the current count of the TCO timer. Writing any value to this register will reload the timer to prevent the timeout.

TCO Timer Status (TCO_STS) - Offset 64h

Bit Range	Default & Access	Field Name (ID): Description
31:18	0h RO	Reserved (reserved2): Reserved.
17	0h RW/1C/V	Second Timeout Status (second_to_sts): PMC sets this bit to 1 to indicate that the TIMEOUT bit had been (or is currently) set and a second timeout occurred before the TCO_RLD register was written. If this bit is set and the NO_REBOOT config bit is 0, then the PMC will reboot the system after second timeout. The reboot is done by interrupting the Arc and starting a reset flow based on the OS_POLICY. This bit is only cleared by writing a 1 to this bit or by a reset. On some prior platforms, this field is reset on RSMRST_B, a reset signal based on a RSMRST# pin that indicates the suspend/resume voltages are stable. This field is reset on RSM_RST_N de-assertion. This field is not reset on cold reset, warm reset, an Sx.
16:4	0h RO	Reserved (reserved1): Reserved.

10.4 Input/output address areas

Bit Range	Default & Access	Field Name (ID): Description
3	0h RW/1C/V	Timeout (tco-timeTCOut): Bit set to 1 by PMC to indicate that the SMI was caused by TCO timer reaching 0. Reset: On cold boot, cold reset, warm reset, and Sx.
2:0	0h RO	Reserved (rsvd): Reserved.

TCO Timer Control (TCO1_CNT) - Offset 68h

Bit Range	Default & Access	Field Name (ID): Description
31:22	0h RO	Reserved (rsvd): Reserved.
21:20	0h RW	OS Policy (os-policy): OS-based software writes to these bits to select the policy that BIOS will use after the platform resets due to the WDT. The following convention is recommended for the BIOS and OS: 00: Boot normally 01: Shut down 10: Don't load OS. Hold in pre-boot state and use LAN to determine next step. 11: Reserved Reset on RSM_RST_N de-assertion only.
19:13	0h RO	Reserved (reserved2): Reserved.
12	0h RW/L	TCO Lock (tco_lock): When set to 1, this bit prevents writes from changing the TCO_EN bit (in offset 30h of Power Management I/O space). Once this bit is set to 1, it cannot be cleared by software writing a 0 to this location. Reset is required to change this from 1 to 0. This bit defaults to 0. On some prior platforms, this field is reset on cold reset. This is reset on cold boot, cold reset, warm reset, and Sx.
11	0h RW	TCO Timer Halt (tco_tmr_halt): 1: The TCO Timer will halt. It will not count, and thus cannot reach a value that would cause an SMI# or cause the SECOND_TO_STS bit to be set. This will also prevent rebooting. 0: The TCO timer is enabled to count. This is the default. This is reset on cold boot, cold reset, warm reset, and Sx.
10:0	0h RO	Reserved (reserved1): Reserved.

TCO Timer Register (TCO_TMR) - Offset 70h

Bit Range	Default & Access	Field Name (ID): Description
31:26	0h RO	Reserved (reserved1): Reserved.
25:16	4h RW	TCO Timer Reload Value (tco_trld_val): Value that is loaded into the timer each time the TCO-RLD register is written. Values of 0000h or 0001h will be ignored and should not be attempted. The timer is clocked at approximately 0.6 seconds, and thus allows timeouts ranging from 1.2 seconds to 613.8 seconds. Note: The timer has an error of +/- 1 tick (0.6s). The TCO Timer will only count down in the S0 and S0IX state.
15:0	0h RO	Reserved (rsvd): Reserved.

No Reboot:

PBASE = Bus 0 Device 0x0d Function 1 Reg. 0x10

PM CFG - Power Management Configuration (PMC_CFG) Offset = 0x1008h

NO Reboot = PBASE +PM CFG Offset Bit [4] set to 1

10.4.3 MMIO GPIO addresses for LEDs and battery monitoring

COMMUNITY_BASE = Bus 0 Device 0x0d Function 0 Reg. 0x10

GPIO North Community PORT ID = 0xC5

GPIO North West Community PORT ID = 0xC4

GPIO_PADBAR = COMMUNITY_BASE + PORT ID << 16 + 0x500

GPO Reg = GPIO_PADBAR + GPIO_Offset Bit [0] (LEDs)

GPI Reg = GPIO_PADBAR + GPIO_Offset Bit [1] (Battery)

Example: Reg LED_USER1_RD_N_P1V8A = 0xD0C506A0

Function	Community Offset	Direction	Description
LED	0x1A0	Out	Low enable red User LED1
LED	0x1A8	Out	Low enable green User LED1
LED	0x1C8	Out	Low enable red User LED2
LED	0x1D0	Out	Low enable green User LED2
LED	0x1E0	Out	Low enable red User LED3
LED	0x198	Out	Low enable green User LED3
LED	0x1C0	Out	BIOS boot indicator Low= OS Control High= in BIOS Boot Time
Battery	0x1E8	In	High= CMOS battery level below 2.75V
Battery	0x1B8	In	High= CMOS battery level below 2.5V
Battery	0x148	Out	High= enable CMOS Battery Check. Must be set to 1 to read battery status

Technical support

A.1 Service and support

You can find additional information and support for the products described on the Internet at the following addresses:

- Technical support (<https://support.industry.siemens.com/cs/ww/en/>)
- Support request form (<http://www.siemens.com/automation/support-request>)
- After Sales Information System SIMATIC IPC/PG (<http://www.siemens.com/asis>)
- SIMATIC Documentation Collection (<http://www.siemens.com/simatic-ipc-doku-portal>)
- Your local representative (<http://www.automation.siemens.com/mcms/aspa-db/en/Seiten/default.aspx>)
- Training center (<http://sitrain.automation.siemens.com/sitrainworld/?AppLang=en>)
- Industry Mall (<https://mall.industry.siemens.com>)

When contacting your local representative or Technical Support, please have the following information at hand:

- MLFB of the device
- BIOS version for industrial PC or image version of the device
- Other installed hardware
- Other installed software

Current documentation

Always use the current documentation available for your product. You can find the latest edition of this manual and other important documents by entering the article number of your device on the Internet. If necessary, filter the comments for the entry type "Manual".

Tools & downloads

Please check regularly if updates and hotfixes are available for download to your device. The download area is available on the Internet at the following link:

After Sales Information System SIMATIC IPC/PG (<http://www.siemens.com/asis>)

A.2 Troubleshooting

This section provides you with tips on how to locate and/or troubleshoot problems which occur.

Problem	Possible cause	Possible remedy
The device is not operational	No power supply	<ul style="list-style-type: none"> • Check the power supply, the power cord and the power plug. • Check if the On/Off switch is in the correct position.
	Device is being operated outside the specified ambient conditions	<ul style="list-style-type: none"> • Check the ambient conditions. • After transport in cold weather, wait approximately 12 hours before switching on the device.
The monitor remains dark	The monitor is switched off	Switch on the monitor.
	The monitor is in "power save" mode	Press any key on the keyboard.
	The brightness button has been set to dark	Increase brightness using the brightness button. For detailed information, refer to the monitor operating instructions.
	The power cord or the monitor cable is not connected.	<ul style="list-style-type: none"> • Check whether the power cord has been properly connected to the monitor and to the system unit or to the grounded shockproof outlet. • Check whether the monitor cable has been properly connected to the system unit and to the monitor. <p>If the monitor screen still remains dark after you have performed these checks and measures, contact your technical support team.</p>
The mouse pointer does not appear on the screen	The mouse driver is not loaded	Check whether the mouse driver is properly installed and available when you start the user program. Detailed information about the mouse driver is available in the corresponding documentation.
	Mouse not connected	<ul style="list-style-type: none"> • Check whether the mouse cord is properly connected to the system unit. • If you use an adapter or extension for the mouse cable, also check these connectors.
		If the mouse pointer still does not appear on the screen after you have performed these checks and actions, contact your technical support team.
Wrong time and/or date on the PC		<ol style="list-style-type: none"> 1. Open the BIOS Setup. 2. Set the time or date.
Although the BIOS setting is OK, the time and data are still wrong	The backup battery is dead.	Replace the backup battery.

Problem	Possible cause	Possible remedy
USB device not responding	The USB ports are not correctly supported.	<ul style="list-style-type: none">• Turn on USB Legacy Support for mouse and keyboard.• For other devices, you need the USB device drivers for the required operating system.
"chkdsk" is not functioning	UWF (Unified Write Filter) is active. The "chkdsk" command is not supported if the UWF is activated.	Deactivate the UWF or use an alternative method to "chkdsk".









Markings and symbols

B.1 Overview



The following tables show all the symbols which may be found on your SIMATIC industrial PC in addition to the symbols which are explained in the operating instructions.

The symbols on your device may vary in some details from the symbols shown in the following tables.

B.2 Safety



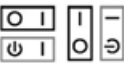







Symbol	Meaning	Symbol	Meaning
	Warning, observe the supplied documentation.		Lock is closed
	Attention, radio equipment		Lock is open
	Disconnect the power plug before opening		Opening for Kensington lock
	Attention ESD (Electrostatic sensitive device)		Warning of hot surface

B.3 Operator controls















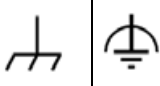



Symbol	Meaning	Symbol	Meaning
	On/off switch, without electrical isolation		Eject CD/DVD
	On/off switch, without electrical isolation		

B.4 Certificates, approvals and markings

The following table shows symbols relating to certificates, approvals and markings which may be on the device.

Symbol	Meaning	Symbol	Meaning
	Approved for Australia and New Zealand		Marking for the Eurasian Customs Union
	Approved for China		Test mark of Factory Mutual Research
	CE markings for European countries		Marking of Federal Communications Commission for the USA
	EFUP (Environment Friendly Use Period) marking for China		Approved for Korea
	Test mark of the Underwriters Laboratories		Disposal information, observe the local regulations.

B.5 Interfaces

Symbol	Meaning	Symbol	Meaning
	Connection to the power supply		PS/2 mouse interface
	Protective conductor terminal		PS/2 keyboard-interface
	Connection for functional earthing (equipotential bonding line)		Multimedia Card Reader
DPP	DisplayPort interface		Smart Card Reader
	DVI-D interface		Line In
LAN 	LAN interface, not approved for connecting WAN or telephone		Line Out
	Serial port		Microphone input
	USB port		Universal Audio Jack
	USB 2.0 high-speed port		Headphone output
	USB 3.0 super-speed port		

List of abbreviations

C.1 Abbreviations

AC	Alternating current	Alternating current
ACPI	Advanced Configuration and Power Interface	
AHCI	Advanced Host Controller Interface	Standardized controller interface for SATA devices. This is supported in Microsoft Windows XP as of SP1 and IAA driver.
APIC	Advanced Programmable Interrupt Controller	
BIOS	Basic Input Output System	
CE	Communauté Européenne	
CMOS	Complementary Metal Oxide Semiconductors	
COA	Certificate of authentication	
COM	Communications Port	Term for the serial interface
CPU	Central Processing Unit	CPU
CSA	Canadian Standards Association	Canadian organization for tests and certifications according to national or binational standards
DC	Direct Current	DC current
DOS	Disk Operating System	
DP	DisplayPort	
DQS	Deutsche Gesellschaft zur Zertifizierung von Qualitätsmanagement mBH	
ESD	Components sensitive to electrostatic charge	
EN	European standard	
ESD	Electrostatic Sensitive Device	Electrostatic Sensitive Devices
	Electrostatic discharge	Electrostatic discharge
GND	Ground	Chassis ground
HD	Hard disk	Hard disk
HDD	Hard Disk Drive	HDD
I/O	Input/Output	Data input/output for computers
IEC	International Electrotechnical Commission	
IGD	Integrated Graphics Device	

IP	International Protection in English-speaking countries: Ingress Protection	Degree of protection
ISA	Industry Standard Architecture	Bus for expansion modules
LAN	Local Area Network	Computer network that is limited to a local area.
LED	Light Emitting Diode	Light emitting diode
LPS	Limited Power Source	
MAC	Media access control	Media access control
MLFB	Machine-readable product designation	
MUI	Multilanguage User Interface	Language localization in Windows
NTFS	New Technology File System	
ODD	Optical Disk Drive	
PCI	Peripheral Component Interconnect	High-speed expansion bus
PCIe	Peripheral Component Interconnect express	High-speed serial, differential full-duplex PtP interface with high data rate.
PG	Programming device	
POST	Power On Self Test	
PXE	Preboot Execution Environment	Software for running new PCs without hard disk data via the network
RAL	Restricted Access Location	
RAM	Random Access Memory	
ROM	Read-Only Memory	
SATA	Serial Advanced Technology Attachment	
SCU	Setup Configuration Utility	
SELV	Safety Extra Low Voltage	Safety extra low voltage
SMART	Self Monitoring Analysis and Reporting Technology	Hard disk error diagnostics program
SRAM	Static Random Access Memory	Static RAM
SSD	Solid State Drive	
TFT	Thin-Film-Transistor	
TxD	Transmit Data	Data transfer signal
UEFI	Unified Extensible Firmware Interface	
UL	Underwriters Laboratories Inc.	US organization for testing and certification according to national or binational standards.
USB	Universal Serial Bus	
UWF	Unified Write Filter	
WD	Watchdog	Program monitoring with error detection and alarming.

Glossary

AHCI mode

AHCI is a standardized method to address the SATA controller. AHCI describes a structure in the RAM, which contains a general area for control and status, as well as a command list.

Automation system

A programmable controller (PLC) of the SIMATIC S7 system consist of a central controller, one or several CPUs, and various I/O modules.

Backup

Duplicate of a program, data medium or database, used either for archiving purposes or for the protection of vital and non-replaceable data against loss when the working copy is corrupted. Certain applications automatically generate backup copies of data files, and manage both the current and the previous versions on the hard disk.

Cache

High-speed access buffer for interim storage (buffering) of requested data.

CE marking

Communauté Européene: The CE symbol confirms the conformity of the product with all applicable EC directives such as the EMC Directive.

Cold restart

A start sequence, starting when the computer is switched on. The system usually performs some basic hardware checks within the cold start sequence, and then loads the operating system from the hard disk to work memory -> boot

Configuration files

These are files containing data which define the configuration after restart. Examples of such files are CONFIG.SYS, AUTOEXEC.BAT and the registry files .

Configuration software

The configuration software updates the device configuration when new modules are installed . This is done either by copying the configuration files supplied with the module or by manual configuration using the configuration utility.

Controller

Integrated hardware and software controllers that control the functions of certain internal or peripheral devices (for example, the keyboard controller).

Drivers

Program parts of the operating system. They adapt user program data to the specific formats required by I/O devices such as hard disk, printers, and monitors.

EMC directive

Directive concerning **Electromagnetic Compatibility**. Compliance is confirmed by the CE symbol and the EC certificate of conformity.

Energy management

The energy management functions of a modern PC allow individual control over the current consumption of vital computer components (e.g. of the monitor, hard disk and CPU), by restricting their activity based on the current system or component load. Energy management is of particular importance for mobile PCs.

Energy options

The energy options can be used to reduce energy consumption of the computer, while keeping it ready for immediate use. This can be configured in Windows by selecting Settings > Control Panel > Energy options.

ESD Guideline

Guideline for using electrostatic sensitive components.

Ethernet

Local network (bus structure) for text and data communication with a transfer rate of 10/100/1000 Mbps.

Execute Disable Capability

Hardware implementation that prevents mutual memory accesses by programs and applications. It is only effective when all relevant system components, such as processors, operating systems and applications are supported.

Extensible Firmware Interface

Refers to the central interface between the firmware, the individual components of a computer and the operating system. EFI is located logically beneath the operating system and represents the successor to PC BIOS, focusing on 64-bit systems.

Formatting

Formatting deletes all data on a data medium. All data media must be formatted prior to their first use.

Hub

A term in network technology. In a network, a device joining communication lines at a central location, providing a common connection to all devices on the network.

IGD

Integrated Graphics Device. Graphics interface integrated in the chipset.

Image

This refers to the image, for example, of hard disk partitions saved to a file in order to restore them when necessary.

Intel Active Management Technology

This technology permits diagnostics, management and remote control of PCs. It is only effective when all relevant system components, such as processors, operating systems and applications are supported.

Interface

- Physical interconnection (cable) of hardware elements such as PLCs, PCs, programming devices, printers or monitors.
- Interface for interactive software applications.

LAN

Local Area Network: LAN is a local network that consists of a group of computers and other devices that are distributed across a relatively restricted range and are linked with communication cables. The devices connected to a LAN are called nodes. The purpose of networks is the mutual use of files, printers or other resources.

License key

The license key represents the electronic license stamp of a license. Siemens AG issues a license key for each software that is protected by a license.

Low-voltage directive

EC Product Safety Directive relating to the safety of products which are operated on low voltage (50 V AC to 1000 V AC, 70 V DC to 1500 V DC) and not specified in other directives. Compliance is confirmed by the CE symbol and the EC certificate of conformity.

Motherboard

The motherboard is the core of the computer. Here, data are processed and stored, and interfaces and device I/Os are controlled and managed.

Operating system

Generic term which describes all functions for controlling and monitoring user program execution, distribution of system resources to the user programs and maintaining the operating mode in conjunction with the hardware (for example, Windows 10).

Pixel

The pixel represents the smallest element that can be reproduced on-screen or on a printer.

Plug&Play

Generally, a reference to the ability of a computer to automatically configure the system for communication with peripheral devices (for example monitors, modems or printers). The user can plug in a peripheral and "play" it at once without manually configuring the system. A Plug&Play PC requires both a BIOS that supports Plug&Play and a Plug&Play expansion card.

POST

Self-test performed by the BIOS after the computer is switched on. Performs a RAM test and a graphics controller test, for example. The system outputs audible signals (beep codes) if the BIOS detects any errors; the relevant message indicating cause of error is output on the screen.

Programmable controller

The programmable controllers of the SIMATIC S7 system consist of a central controller, one or more CPUs, and various other modules (e.g. I/O modules).

PXE server

A Preboot Execution Environment server is part of a network environment and can provide software to connected computers even before they boot. This can involve operating system installations or servicing tools, for example.

RAL

Restricted Access Location: Installation of the device in a production facility with restricted access, for example, a locked control cabinet.

Recovery function of the USB stick

Contains the tools for configuring hard disks and the Windows operating system.

Reset

Hardware reset: Reset/restart of the PC using a button/switch.

Restart

Warm restart of a computer without switching the power off (Ctrl + Alt + Del)

Restore function of the USB stick

The Restore function is used to restore the system partition or the entire hard disk to factory state in the event of a fault. The USB stick contains all the necessary image files and is bootable.

ROM

Read-Only Memory ROM is a read-only memory in which every memory location can be addressed individually. The programs or data are permanently stored and are not lost in the event of a power failure.

S.M.A.R.T

Self-Monitoring, Analysis and Reporting Technology (SMART or S.M.A.R.T.) is an industry standard integrated in storage media. It makes for permanent monitoring of important parameters and early detection of imminent problems.

SATA

Serial ATA Interface for hard disk drives and optical drives with serial data transmission.

SETUP (BIOS Setup)

A program in which information about the device configuration (that is the configuration of the hardware on the PC/PG) is defined. The device configuration of the PC/PG is preset with defaults. Changes must therefore be entered in the SETUP if a memory expansion, new modules or a new drive are added to the hardware configuration.

SSD (Solid State Drive)

A Solid State Drive is a drive that can be installed like any other drive; it does not contain a rotating disk or other moving parts because only semiconductor memory chips of similar capacity will be used. This design makes SSDs more rugged, provides shorter access times, low energy consumption and rapid data transfer.

STEP 7

Programming software for the creation of user programs for SIMATIC S7 controllers.

Wake on LAN

Wake on Local area network. This function allows the PC to be started via the LAN interface.

Warm restart

The restart of a computer after a program was aborted. The operating system is loaded and restarted again. The CTRL+ ALT+ DEL hotkey can be used to initiate a warm restart.

Index

A

Australia, 61

B

Backup battery, 42
 Installing, 46, 48
Battery monitoring, 42

C

CE marking, 59
Certificates, 59
 Certifications and approvals, 59
chkdsk, 85
COA label, 22
Components sensitive to electrostatic charge, 64
Condensation, 20
Connecting
 Network, 36
 Peripherals, 31
 Protective conductor, 33
Creating an image, 52

D

Data backup, 52
Data exchange, 36
DC power supply, 58
Degree of protection, 53
Device
 Power on, 38
DiagBase software, 39
DiagMonitor
 Temperature monitoring, 40
DiagMonitor software, 39
Diagnostics, 39, 39
 DiagBase software, 39
 DiagMonitor software, 39
Directive
 ESD Directive, 64
DisplayPort
 Interface, 76
Drive, 54

E

EAC, 61
Electromagnetic compatibility, 63
EMC, (Electromagnetic compatibility)
ESD, 64
ESD Directive, 64
Ethernet, 36, 75
EU Declaration of Conformity, 59

F

FCC, 60

G

General technical specifications, 53
Graphics, 54

I

Identification data, 21
Industrial Ethernet, 36
Initial commissioning, 38
Installing
 Backup battery, 46, 48
Integration
 Ethernet, 36
 Industrial Ethernet, 36
 PROFINET, 36
Interface, 55
Interfaces
 DisplayPort, 76
 USB 3.0, 75
IT communication, 36

L

Labeling, 61
 Korea, 61
Lateral mounting on a standard rail, 68
Limitation of liability, 44

M

- Main memory, 54
- Marking
 - EU Declaration of Conformity, 59
- Memory medium, 54
- Monitoring functions, 39
- Motherboard
 - Technical features, 75
- Mounting
 - Standard mounting rail, 26
 - Upright, 29, 30
 - Wall, 28
- Mounting on a standard rail, 26, 67, 71
- Mounting type, 24

N

- Nameplate, 21
- New Zealand, 61

O

- Operating system
 - Initial commissioning, 38

P

- Package contents, 19
 - Checking, 19
- Packaging, 19
 - Checking, 19
 - Removing, 19
- Partitioning
 - SSD drive, 51
- Power supply
 - Connecting, 35
 - DC power supply, 58
- Processor, 54
- PROFINET, 36, 58
- Protection class, 53
- Protective conductor, 33
 - Connecting, 33
- Protective measure
 - Static electricity, 66

R

- Radiation, 16
 - High frequency radiation, 16
- Repairs, 44

S

- Safety information
 - Storage, 20
 - Transportation, 20
- SIMATIC NET, 36
- SIMATIC S7, 36
 - Integration, 36
- SSD drive
 - Partitioning, 51
- Static electricity
 - Protective measures, 66
- Supply voltage, 53
- System resources, 78
 - Currently allocated system resources, 78

T

- Teaming, 55
- Temperature monitoring, 40

U

- Upright mounting, 29, 30, 70, 74
- USB, 75
- USB 3.0
 - Interface, 75

W

- Wall mounting, 28, 69, 73
- Warranty, 15
- Watchdog, 41
 - Monitoring function, 41
 - Monitoring times, 41
- Weight, 53
- Windows 7 Ultimate
 - Data backup, 52
- Windows Embedded Standard
 - Data backup, 52
- Windows XP Professional
 - Data backup, 52